

GL7000

DATA PLATFORM

USER'S MANUAL

MANUAL NO.GL7000-UM-156

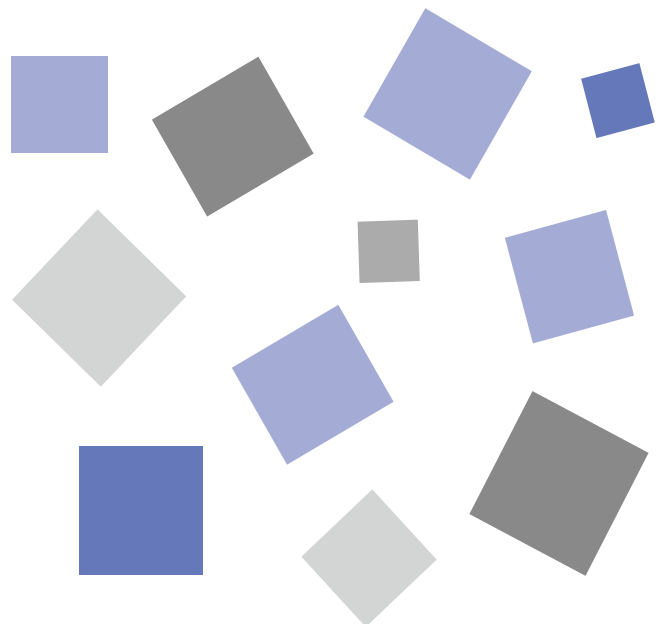





GRAPHTEC

To Ensure Safe and Correct Use









- To ensure safe and correct use of the GL7000, read this Manual thoroughly before use.
- After having read this Manual, keep it in a handy location for quick reference as needed.
- Do not permit small children to touch the GL7000.
- The following describes important points for safe operation. Please be sure to observe them strictly.

Conventions Used in This Manual

To promote safe and accurate use of the GL7000 as well as to prevent human injury and property damage, safety precautions provided in this manual are ranked into the five categories described below. Be sure you understand the difference between each of the categories.

 DANGER	This category provides information that, if ignored, is highly likely to cause fatal or serious injury to the operator.
 WARNING	This category provides information that, if ignored, is likely to cause fatal or serious injury to the operator.
 CAUTION	This category provides information that, if ignored, could cause physical damage to the GL7000.
 HIGH TEMPERATURE	This category provides information that, if ignored, is likely to cause burns or other injury to the operator due to contact with high temperature.
 ELECTRICAL SHOCK	This category provides information that, if ignored, is likely to expose the operator to electrical shock.

Description of Safety Symbols

	The  symbol indicates information that requires careful attention (which includes warnings). The point requiring attention is described by an illustration or text within or next to the  symbol.
	The  symbol indicates action that is prohibited. Such prohibited action is described by an illustration or text within or next to the  symbol.
	 The symbol indicates action that must be performed. Such imperative action is described by an illustration or text within or next to the  symbol.

Safety Precautions

⚠ WARNING

Be sure to securely connect the GL7000's power cord.

- After checking that the Power switch is turned off, connect the power cord's female plug to the GL7000 and then connect its male plug into the electrical socket.
- Use of the GL7000 without the power cord securely plugged into the electrical socket may result in electrical shock due to current leakage.
- Before running the GL7000, be sure to ground the protective ground terminal (⚡) to avoid electrical shock and fire hazards. For grounding, use a ground wire with a diameter of at least 0.75 mm². When using the GL7000 in an environment where grounding is not possible, ensure that the voltage to be measured is no greater than 50 V (DC or rms).



Securely connect the power cord. Make sure that the socket has a good protective ground.

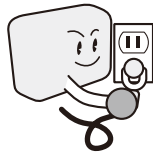

If the GL7000 generates smoke, is too hot, emits a strange odor, or otherwise functions abnormally, turn off its power and unplug its power cord from the electrical socket.

- Use of the GL7000 in such status may result in a fire hazard or electrical shock.
- After checking that smoke is no longer being generated, contact your sales representative or nearest Graphtec vendor to request repair.
- Never try to perform repair yourself. Repair work by inexperienced personnel is extremely dangerous.



Amateur repair prohibited

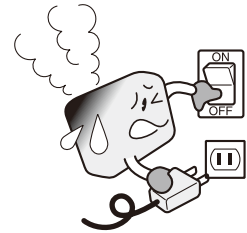

Before turning on the GL7000, ensure that the electric socket's supply voltage conforms to the GL7000's power rating.

- Use of a different supply voltage may cause damage to the GL7000 or a fire hazard due to electrical shock or current leakage.



Amateur repair prohibited



Never disassemble or remodel the GL7000.

- Such action may cause a fire hazard due to electric shock or current leakage.
- Contact with a high-voltage component inside the GL7000 may cause electric shock.
- If repair is required, contact your sales representative or nearest Graphtec vendor.



No disassembly



Avoid using the GL7000 in extremely dusty or humid places.

- Such use may cause a fire hazard due to electrical shock or current leakage.



Use prohibited



Watch out for electrical shock



Avoid using the GL7000 in places where it may be exposed to water such as bathrooms, locations exposed to wind and rain, and so on.



Avoid water



Watch out for electrical shock

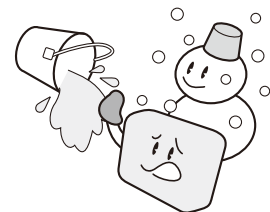

Prevent dust or metallic matter from adhering to the power supply connector.

- Adhesion of foreign matter may cause a fire hazard due to electrical shock or current leakage.



No foreign matter



Watch out for electrical shock

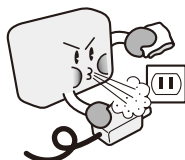

Never use a damaged power cord.

- Use of a damaged cord may result in a fire hazard due to electrical shock.
- If the cord becomes damaged, order a new one to replace it.



Unplug the power cord from the socket



Safety Precautions

⚠ CAUTION

Do not use or store the label printer in a location exposed to direct sunlight or the direct draft of an air conditioner or heater.

- Such location may impair the GL7000's performance.



Storage/Use prohibited

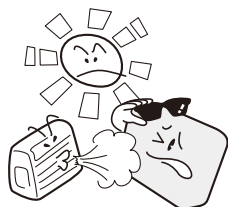

Do not place coffee cups or other receptacles containing fluid on the GL7000.

- Fluid spilling inside the GL7000 may cause a fire hazard due to electrical shock or current leakage.



Avoid water



Watch out electrical shock



Do not use the GL7000 in a location subject to excessive mechanical vibration or electrical noise.

- Such location may impair the GL7000's performance.



Use prohibited

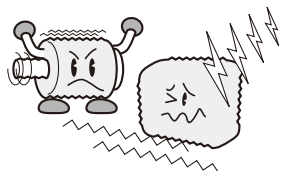

To insert or disconnect the power cord or a signal input cable, grasp the power cord's plug or the signal input cable's connector.

- Pulling the cord/cable itself damages the cord/cable, resulting in a fire hazard or electrical shock.



No pulling

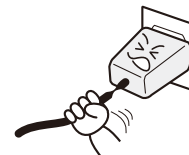

If fluid or foreign matters enters inside the GL7000, turn off the Power switch and disconnect the power cord from the electrical socket.

- Use in such status may cause a fire hazard due to electrical shock or current leakage.
- Contact your sales representative or nearest Graphtec vendor to request repair.



Unplug the power cord from the socket

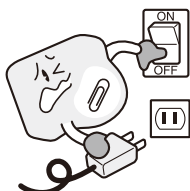

Do not input voltage that exceeds the permissible input voltage range that is specified on the GL7000's label.

- Exceeding the specified voltage input range may cause electrical shock or a fire hazard.



Use prohibited



Do not attempt to lubricate the GL7000's mechanisms.

- Such action may cause the GL7000 to break down.



No lubrication

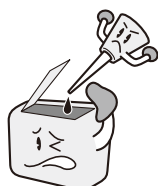

Never clean the GL7000 using a volatile solvent (such as thinner or benzene).

- Such action may impair the GL7000's performance.
- Clean off any soiled areas using a soft dry cloth.



No volatile solvent



To ensure safe and correct use of your GL7000, read this manual thoroughly before use.

If the equipment is used in a manner not specified by the manufacture, the protection provided by the equipment may be impaired.

Introduction

Thank you for purchasing the GL7000 DATA PLATFORM.

Please read this manual thoroughly before attempting to use your new product to ensure that you use it correctly and to its full potential.

Notes on Use

Be sure to read all of the following notes before attempting to use the GL7000 DATA PLATFORM.

1. Note on the CE Marking

The GL7000 complies with the EN61326-1 (Class A) standard based on the EMC directive (2014/30/EU).

It also conforms to the EN61010-1 standard based on the LV directive (2014/35/EU).

Although the GL7000 complies with the above-mentioned standards, be sure to use it correctly in accordance with the instructions and notes provided in its User's Manual.

Moreover, use of the GL7000 by incorrect procedures may result in damage to the GL7000 or may invalidate its safeguards. Please confirm all of its notes regarding use and other related information to ensure correct use.

2. Warning

This is a Class A product according to the EMC directive. In a domestic environment, this product may cause radio interference or may be affected by radio interference to the extent that proper measurement cannot be performed.

3. Notes for Safe Operation

(1) In environments where there is a lot of noise or where the power supply is unstable, we recommend that you ground the GL7000.

(2) When a high-voltage signal cable has been connected to the main unit's analog signal input terminal, avoid touching the leads of the input terminal's signal cable to prevent electrical shock due to high voltage.

(3) Ensure that the GL7000's power source is positioned so that it can easily be disconnected.

4. Notes on Functions and Performance

(1) Be sure to connect the main unit to an AC power supply that conforms to the rated range.

Connection to a non-rated power supply may cause the main unit to overheat and break down.

(2) Do not block the vent on the main unit.

Continued operation with the vent blocked may cause the main unit to overheat and break down.

(3) To avoid malfunctions and other damage, avoid using the GL7000 in the following locations.

- Places exposed to high temperature and/or high humidity, such as in direct sunlight or near heating equipment. (Allowable temperature range: 0 to 45°C, Allowable humidity range: 5 to 85%R.H.)
- Locations subject to excessive salt spray or heavy fumes from corrosive gas or solvents.
- Excessively dusty locations.
- Locations subject to strong vibrations or shock.
- Locations subject to surge voltages and/or electromagnetic interference.

(4) If the main unit becomes soiled, wipe it off using a soft, dry cloth. Do not use the organic solvents (such as thinner or benzene).

(5) Do not use the GL7000 in the vicinity of other devices which are susceptible to electromagnetic interference.

Introduction

- (6) Measured results may not conform to the stated specifications if the GL7000 is used in an environment which is subject to strong electromagnetic interference.
- (7) Insofar as possible, position the GL7000 input signal cables away from any other cables which are likely to be affected by electromagnetic interference.
- (8) For stabilized measurement, allow the GL7000 to warm up for at least 30 minutes after turning it on.

About Registered Trademarks

- Microsoft and Windows are registered trademarks or trademarks of Microsoft Corporation in the U.S. and elsewhere.
- Other company names and product names included in this manual are registered trademarks or trademarks of their respective companies.

CONTENTS

To Ensure Safe and Correct Use	i
Safety Precautions	ii
Safety Precautions	iii
Introduction	I
Notes on Use	I
About Registered Trademarks	II

CHAPTER 1 General Description

1.1 Overview	1-2
1.2 Features	1-2
1.3 Operating Environment	1-4
Ambient Operating Conditions	1-4
Warming-up Before Use	1-4
Configuration When in Use	1-5
1.4 Notes on Temperature Measurement (Optional)	1-6
1.5 Notes on Using the Monitor	1-6
1.6 Changing the Display Language	1-7
1.7 Explanation of symbols used on the equipment	1-7

CHAPTER 2 Checks and Preparation

2.1 Checking the Outer Casing	2-2
2.2 Checking the Accessories	2-2
Standard Accessories	2-2
2.3 Checking the Optional Modules	2-2
Optional Modules	2-2
2.4 Checking the Optional Accessories	2-3
2.5 Main module Nomenclature and Functions	2-4
2.6 Module Nomenclature and Functions	2-6
Display Module (GL7-DISP): Optional	2-6
SSD Module (GL7-SSD): Optional	2-8
Voltage Module (GL7-V): Optional	2-9
High speed voltage Module (GL7-HSV): Optional	2-10
Voltage/Temperature Module (GL7-M): Optional	2-11
Logic/Pulse Module (GL7-L/P): Optional	2-12
High voltage Module (GL7-HV): Optional	2-13
DC Strain Module (GL7-DCB): Optional	2-14
Charge Module (GL7-CHA): Optional	2-15
Voltage Output Module (GL7-DCO): Optional	2-16
2.7 Installing and removing the Module	2-17
Installing the Display Module (GL7-DISP: optional) and GL7000	2-17
Installing the amplifier module for measurement (optional) and main module	2-22
2.8 Installing	2-26
Installation location	2-26
How to install (GL7000 and amplifier module, etc.)	2-27

2.9	Connecting the Power Cable and Turning on the Power	2-28
	When using AC power	2-28
	Connecting to the GND terminal	2-29
2.10	How to Connect to Analog Signal Input Terminal and Precautions	2-30
	(1) Voltage Module (GL7-V: Optional)	2-30
	(2) Voltage/Temperature Module (GL7-M: Optional)	2-31
	(3) High Speed Voltage Module (GL7-HSV: Optional)	2-33
	(4) Logic/Pulse Module (GL7-L/P: Optional)	2-34
	(5) High-voltage Module (GL7-HV: Optional)	2-36
	(6) DC Strain Module (GL7-DCB: Optional)	2-37
	(7) Charge Module (GL7-CHA): Optional	2-42
	(8) Voltage Output Module (GL7-DCO): Optional	2-44
2.11	Input/output Cable Connection for GL	2-45
	Internal equivalent circuit in input/output circuit	2-46
	GL input and output cabling	2-46
	REMOTE Functions	2-47
2.12	Noise Countermeasures	2-48

CHAPTER 3 Measure and Set

3.1	Nomenclature	3-2
	(1) Waveform + Digital Screen	3-2
	(2) HOME screen	3-9
	(3) Navigator	3-11
	(4) Menu screen	3-12
	(5) Settings screen	3-13
	(6) Menu tree	3-15
3.2	Touch-panel Functions	3-26
3.3	Explanation of the Common Process Screens	3-28
	(1) Numerical entry	3-28
	(2) Enter a character	3-30
	(3) File operations	3-32
3.4	Key Operations	3-43
3.5	Description of Each Operating Mode	3-48
3.6	Explanation of the Settings Menu	3-58
	(1) Record settings	3-58
	(2) Marker settings	3-75
	(3) Backup settings	3-76
	(4) Output settings	3-77
	(5) Trigger/Alarm settings	3-83
	(6) I/F, USB settings	3-87
	(7) IP settings	3-88
	(8) FTP server settings	3-90
	(9) Date/Time settings	3-92
	(10) Other settings	3-94
	(11) Input settings	3-98
	(12) Trigger level settings	3-128
	(13) Alarm level settings	3-133
	(14) Waveform setting (Simple Waveform Setting)	3-135
	(15) Display settings	3-137
	(16) Replay setting screen (Data relaying screen)	3-152

(17) File operations	3-152
(18) Data Save	3-153
(19) Save/Load current settings	3-154
(20) Swapping out the SD card	3-156
(21) Screenshot	3-158
(22) Cursor position	3-159
(23) Data search	3-161
(24) Action screen	3-163
(25) Statistical calculation	3-164
(26) Data with CSV format	3-165
(27) Output settings (DCO module settings)	3-166
3.7 Web server functions	3-168

CHAPTER 4 Specification

4.1 Standard Specifications	4-2
Standard Specifications	4-2
List of power consumption for each unit	4-3
Internal memory devices	4-3
PCI/F	4-4
4.2 Function Specifications	4-5
Data recording functions	4-5
Trigger and Alarm functions	4-6
Various functions	4-7
External Input/Output functions	4-8
Synchronization function	4-8
4.3 Function Module Specifications	4-9
Display Module (GL-DISP: optional)	4-9
SSD Module (GL7-SSD: optional)	4-9
4.4 Amplifier Module Specifications	4-10
Voltage Module (For voltage measurement) (GL7-V: optional)	4-10
Voltage/Temperature Module (For temperature measurement) (GL7-M: optional)	4-11
High Speed Voltage Amplifier Module (For high speed voltage measurement) (GL7-HSV: optional)	4-12
Logic/Pulse Amplifier Module (Logic/Pulse) (GL7-L/P: optional)	4-13
High-voltage Module (For high-voltage measurements) (GL7-HV: optional)	4-14
DC Strain Module (For Strain/voltage/resistance measurement)(GL7-DCB: optional)	4-16
Charge Module (For Acceleration measurement)(GL7-CHA: optional)	4-18
Voltage Output Module (For output voltage measurement) (GL7-DCO: optional)	4-20
4.5 Accessory/Option Specifications	4-21
Control software (GL-Connection)	4-21
Standard accessories	4-22
Humidity sensor: B-530 (optional)	4-22
4.6 Accessories	4-23
Optional Accessories	4-23
4.7 External view	4-24
INDEX	I-1

CHAPTER 1 General Description

This chapter provides a general description of the GL7000 and its features.

PRODUCT SUMMARY

- 1.1 Overview
- 1.2 Features
- 1.3 Operating Environment
- 1.4 Notes on Temperature Measurement (Optional)
- 1.5 Notes on Using the Monitor
- 1.6 Changing the Display Language
- 1.7 Explanation of symbols used on the equipment

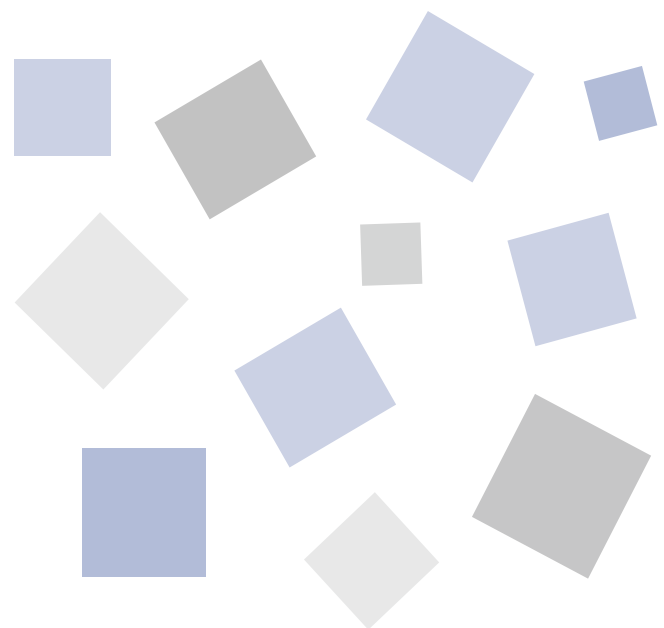

1.1 Overview

The GL7000 is a module-expanding, high speed, multi-function, multi-channel DATA PLATFORM.

A maximum of 10 Amplifier Modules can be expanded, and expansion of an SSD Module and a Display Module makes it suitable for all sorts of needs.

In addition to being able to record measuring data on the built-in RAM, it also comes equipped with a large capacity flash memory. Since recording can be done to an SD card, transferring data to the PC when offline is easy.

For the PC interface, as USB and Ethernet is included as standard, system configuration according to use is possible. As the Ethernet function is equipped with both a WEB server and an FTP server function, remote supervision and data transfer are also possible.

1.2 Features

Input

- In compliance with the diversity of the objects to be measured, an Amplifier Module where the amplifier can be selected has been adopted.

Display and operations

- In compliance with the diversity of the objects to be measured, an Amplifier Module where the amplifier can be selected has been introduced.
- It comes equipped with a high resolution 5.7" TFT color liquid crystal display.
- A capacitive touch-screen is adopted, and because of the easy-to-understand menu configuration operations can easily be carried out.
- By separately placing keys on the touch-screen, we've made it possible to carry out operations in environments where the touch-screen can't be used, such as when wearing gloves.

*: For when the optional Display Module is installed

Recording

- The "Dual sampling" function which can capture the input signal on each medium at two sampling rates has been installed from GL7000 Ver. 2.00. It is possible to use diversified ways to capture at high speed with pinpoint while capturing at low speed for a long time.
- Data can be saved directly to the built-in flash memory, SD card (option) or SSD Module.
* SD card: SDHC equivalent, maximum approx. 32GB (However, up to 4GByte per file)
- Data recorded in the built-in flash memory is retained even if the power is turned off.
- Because disk image can be used for the built-in flash memory, multiple data can be saved.
- High speed recording can be done by recording to the built-in RAM. After confirming the recorded data, if necessary, it can be saved to the built-in flash memory or an SD card.
- Because it comes equipped with a ring recording function, even if doing long time recordings, the latest data always remains. (It needs to specify the number of data to retain.)
- When recording to the built-in RAM, built-in flash memory, or an SD card, even if the number of modules is increased, the sampling rate will not go down.
- Large capacity data (1 file of maximum 4GB) can be recorded in built-in flash memory, SD card (option), SSD Module. (The sampling rate is restricted according to the number of connected modules.)

Data Control & Processing

- The application software provided lets you set conditions and monitor data on a computer.
- With the USB drive mode function, the built-in flash memory, SD card (option) and SSD Module can be recognized from your PC.
(Connect the GL7000 to your PC and turn on the power supply while holding down the [START] key.
Alternatively turn on the power supply after setting the slide switch to the USB drive mode side)
- Recorded data can be read out file and processed displayed data with application software.
- Data can be transferred off-line to a computer using SD card.
- With WEB server function, remote control and monitoring can be performed without using dedicated software.
- With the FTP server function, you can operate the built-in flash memory, SD card (option) and SSD Module.
- With the FTP client function, you can create a backup of the measured data to the FTP server.

1.3 Operating Environment

This section explains the operating environment for the main module.

Ambient Operating Conditions

- (1) Ambient temperature and humidity (the main module must be operated within the following ranges.)
 - Temperature range: 0 to 45°C
 - Humidity range: 5 to 85% RH
- (2) Environment (do not install in the following locations.)
 - Outdoor
 - A Location such as being exposed to direct sunlight
 - Locations exposed to salty air, corrosive gases, or organic solvents
 - Dusty locations
 - Locations subject to vibration or impact
 - Locations subject to voltage surge or electromagnetic interference such as lightning or electric furnaces
- (3) Installation category (overvoltage category)
 - The main module belongs to Installation Category II defined in IEC60664-1.
 - Never use the main module for Installation Category III or IV.
- (4) Measurement category
 - The GL7000 main module is not available in the Measurement Category II, III, IV defined in IEC61010. (The high-voltage module belongs to Measurement Category II.)
- (5) Altitude
 - Altitude up to 2000 m.
- (6) Mains supply voltage
 - 100 to 240 V AC $\pm 10\%$
- (7) Intended use
 - This product intends the industrial equipment usage of Measurement for research of development or Measurement of factory line.

CHECKPOINT

If condensation occurs...

Condensation occurs in the form of water droplets on the device surfaces and interior when the GL7000 is moved from a cold to a warm location. Using the GL7000 with condensation will cause malfunctioning.

Wait until the condensation has disappeared before turning on the power.

Warming-up Before Use

The main module should be allowed to warm up with the power turned on for approximately 30 minutes to ensure that it operates according to the specified performance.

Configuration When in Use

It is recommended to use the main module while it is laid flat or inclined on the stands.

< Usage Configuration >

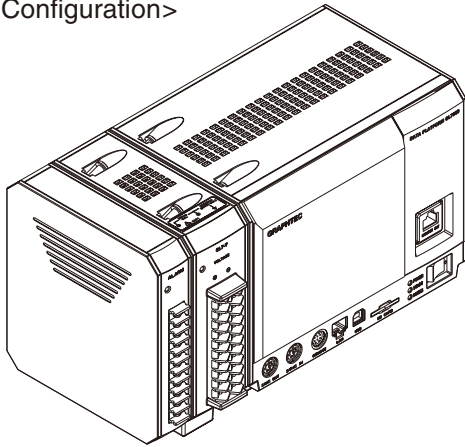

⚠ CAUTION

- To prevent possible malfunction, do not block the air vents of the main module.
 - If you use the main module in other position than described in the above, the measurement accuracy may not meet the specifications.
-

1.4 Notes on Temperature Measurement (Optional)

* When installing optional Voltage/Temperature Module.

Please observe the following precautions when performing temperature measurement.

- Do not block the air vents. Always provide a space of at least 20 cm on all sides of the main module.
- For stabilized temperature measurement, allow the main module to warm up for at least 30 minutes after turning it on.
- Exposure of the input terminals to direct drafts, direct sunlight, or abrupt changes in temperature may impair the equilibrium of the input parts and result in measurement errors. To measure temperature in such an environment, take appropriate countermeasures such as changing the installation site of the main module.
- If you measure in the place where there is a lot of noise, be sure to make a ground connection to the GND terminal on the module (Refer to page 2-48).
- If measured values fluctuate due to noise, slow down the sampling interval (Refer to page 3-49).

1.5 Notes on Using the Monitor

* When installing optional Display Module.

The monitor is an LCD display unit, and so the display will vary depending on the operating environment.

CHECKPOINT

If the screen saver function is used, it will operate and clear the screen if no operations are performed during the preset time. If the screen saver operates, press any key to restore the display.

CAUTION





- Condensation may form on the LCD screen if the GL7000 is moved from a cold to a warm location. If this occurs, wait until the LCD screen warms up to room temperature.
 - The LCD screen is manufactured to extremely high precision. Black dots may appear, or red, blue, and green dots may not disappear. Likewise, streaks may appear when viewed from certain angles. These phenomena are due to the LCD screen construction, and are not signs of a fault.
-

1.6 Changing the Display Language

* When installing optional Display Module.

You can choose either English, Japanese, French, German, Chinese, or Korean as the language displayed on the screen. The default display language is set to English when the main module is shipped overseas. To change the display language, see the instructions in "OTHR:Language".

1.7 Explanation of symbols used on the equipment

Symbols	Meaning	Display locations	Descriptions
	Caution (Refer to Manual)	<ul style="list-style-type: none"> • Front panel of Main module. • Right side panel of Main module. • Front panel of Alarm Output Module • In the label seal of top panel on each measurement module (optional). 	<ul style="list-style-type: none"> • Avoid touching the input terminals and leads of the input terminal's signal cable to prevent electrical shock due to high voltage. • If a voltage exceeding the specified value is input, the main unit will be damaged. • Install the specified cable to each I/F connector.
	Earth (Ground) Terminal	<ul style="list-style-type: none"> • In the label seal of top panel on each measurement modules (optional). 	<ul style="list-style-type: none"> • If the measured value is unstable due to the exogenous noise, it is probably better that the cables are thicker between the GND terminal of DUT and the GND terminal of GL7000. In addition, the both GND terminals should be connected to the earth for same potential level. • If a voltage exceeding the specified value is input, the main unit will be damaged.
	Alternating current	<ul style="list-style-type: none"> • In product identification label of right side on the main unit. 	<ul style="list-style-type: none"> • Be sure to connect the main unit to an AC power supply that conforms to the rated range. Connection to a non-rated power supply may cause the main unit to overheat and break down. • Be careful to electric shock.
	PROTECTIVE CONDUCTOR TERMINAL	<ul style="list-style-type: none"> • Right side panel of the main unit. 	<ul style="list-style-type: none"> • Make sure that the main unit is grounded. • If the main unit is not grounded, the operator could suffer an electrical shock in case of current leakage. • Be sure to ground the grounding cable from the power connector.

CHAPTER 2 Checks and Preparation

This chapter explains how to check the main module's external casing and accessories, and how to prepare the main module for operation.

PRODUCT SUMMARY

- 2.1 Checking the Outer Casing
- 2.2 Checking the Accessories
- 2.3 Checking the Optional Modules
- 2.4 Checking the Optional Accessories
- 2.5 Main module Nomenclature and Functions
- 2.6 Module Nomenclature and Functions
- 2.7 Installing and removing the Module
- 2.8 Installing
- 2.9 Connecting the Power Cable and Turning on the Power
- 2.10 How to Connect to Analog Signal Input Terminal and Precautions
- 2.11 Input/output Cable Connection for GL
- 2.12 Noise Countermeasures

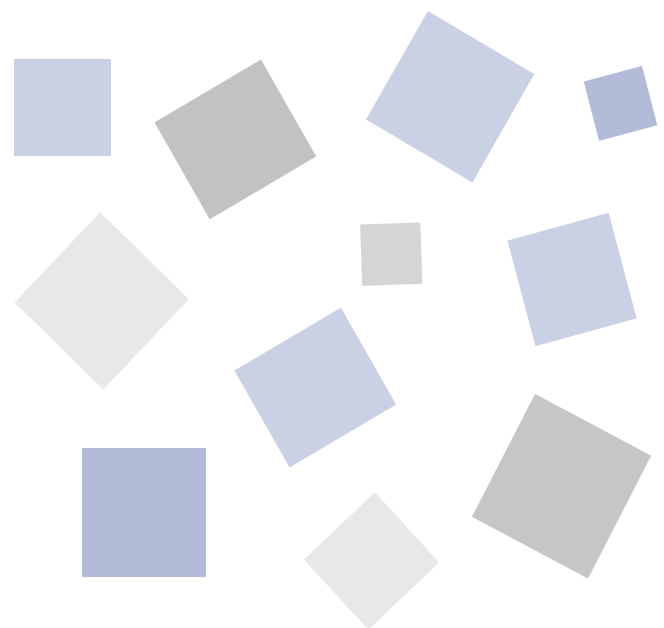

2.1 Checking the Outer Casing

After unpacking, check the GL7000's outer casing before use. In particular, please check for the following:

- Surface scratches
- Other flaws such as stains or dirt

2.2 Checking the Accessories

After unpacking, check that the following standard accessories are included.

Standard Accessories

Item	Description	Quantity
Alarm Module	This is installed in the main module at shipping.	1
Quick Start Guide	GL7000-UM-85X	1
CD-ROM	User's Manual, Application software	1
Face cover	This is installed in the main module at shipping.	1
AC cable		1

2.3 Checking the Optional Modules

Optional Modules

Item	Model	Description
Display Module	GL7-DISP	5.7-inch LCD, Touch-panel, Operation key
SSD Module	GL7-SSD	128GB, SSD
Voltage Module	GL7-V	For voltage measurement
Voltage/temperature Module	GL7-M	For voltage/temperature measurement
High-speed Voltage Module	GL7-HSV	For high-speed voltage measurement
Logic/Pulse Module	GL7-L/P	For logic/pulse measurement
High-voltage Module	GL7-HV	For high-voltage measurement
DC Strain Module	GL7-DCB	For Strain/voltage/resistance measurement
Charge Module	GL7-CHA	For Acceleration measurement
Voltage Output Module	GL7-DOC	For voltage output

2.4 Checking the Optional Accessories

Refer to “Optional” in “4.6 Accessories”.

2.5 Main module Nomenclature and Functions

This section describes the names and function of parts of the main module (Separately, an optional amplifier module is needed).

The Alarm module has been connected to the GL7000 main module at shipping.

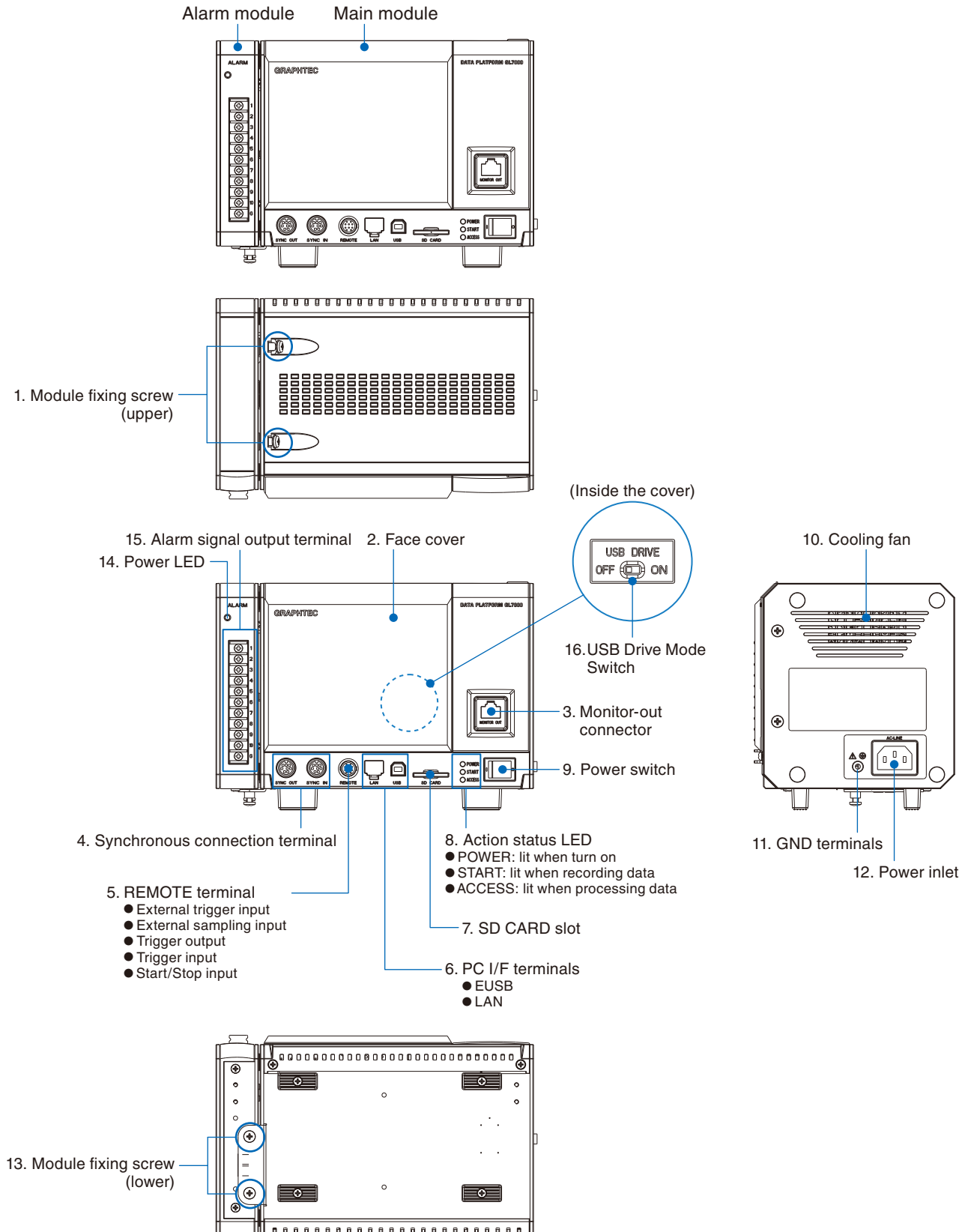

1. Module fixing screw (upper) Fixation screw for the adjoining module.
To prevent drop off, please refrain from removing it from the module.
2. Face cover Remove when the Display Module (optional) is mounted on the main module.
3. Monitor-out connector Connector for connecting the Display Module (optional).
(When using the tilting table and when extending the cable)
4. Synchronous connection terminal
..... Using the GL7000 sync cable (optional), the multiple GL7000 main modules are synchronized.
(Synchronization function is available in GL-Connection only.)
5. REMOTE terminal Manages the main module when using input cable for GL (optional).
6. PC I/F terminals Performs communications between the main module and PC (application) when using a USB/LAN cable.
7. SD CARD slot For inserting an SD CARD.
8. Action status LED Displays a light according to every action.
9. Power switch Turns the power On/Off for every module.
10. Cooling fan Cools the main module.
11. GND terminals Terminal for grounding.
12. Power inlet Connects the attached AC cable.
13. Module fixing screw (lower) Fixation screw for the adjoining module.
14. Power LED Lights up green when the power is turned on and the Alarm Module is recognized.
15. Alarm signal output terminal ... Terminal for outputting the alarm signal.
16. USB Drive Mode switch By turning on, it goes into USB Drive Mode. In USB Drive Mode, you can see the built-in flash memory, SD card, or extended SSD as an external storage device on the computer. Since these are recognized as a removable disk, it is easy to transfer and delete the files.

2.6 Module Nomenclature and Functions

This section describes the names and function of parts of the Module.

⚠ CAUTION

- When installing or removing modules, please make sure that the power is turned off.
- Adequate precautions against static electricity must be taken when handling the modules.
- After installation, please make sure to tighten the screws. If using without tightening the screws, the module may break off during use.

Display Module (GL7-DISP): Optional

⚠ CAUTION

- Since the touch-panel in this module is a capacitive touch-panel, it does not respond by touching it with a pen. Touch the finger without glove.
- Adequate precautions against static electricity must be taken when handling the modules. Please note that if the touch-panel is operated with an object with a sharp edge, it may scratch and damage the touch-panel.
- Do not touch when your hands are wet.

<Display module (GL7-DISP) set contents>

- Display module : 1 module
- Tilting table : 1 module
- Monitor connection cable : 1 pc.
- Screws (M4×6) : 3 pcs.
- Ground cable : 1 pc.
- Flat Head Screws (M4×10) : 2 pcs. (Spare)

Display Module

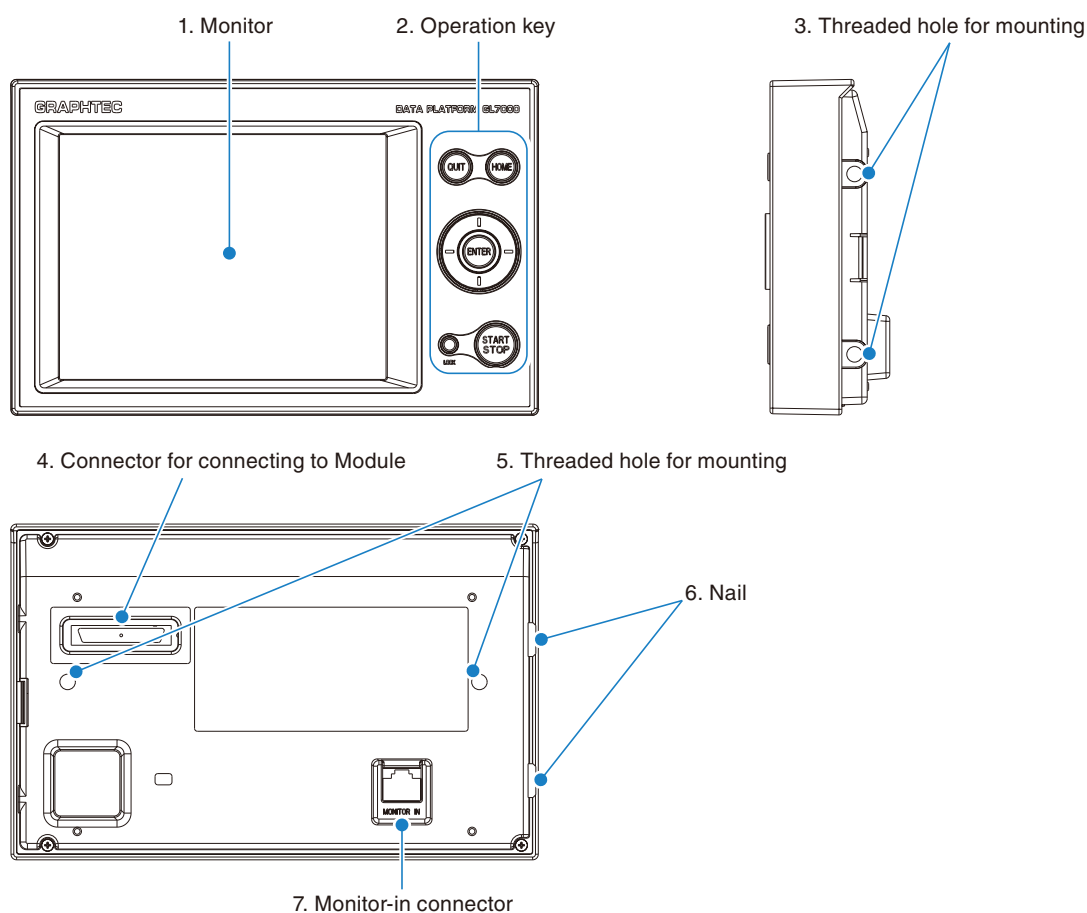

1. Monitor.....LCD monitor equipped with a touch-panel function.
2. Operation keyKey operation is performed on the screen.
 * Almost all operations can be performed on the touch-panel or from operation key.
3. Threaded hole for mountingThreaded hole for fixing to the main module.
4. Connector for connecting to Module
Connector for connecting to the main module.
5. Threaded hole for mountingThreaded hole for fixing to the tilting table (2 places).
6. NailNails for fixing to the main module (2 places).
7. Monitor-in connector.....Connector for use when extending cable, and when using the tilting table.

Tilting table

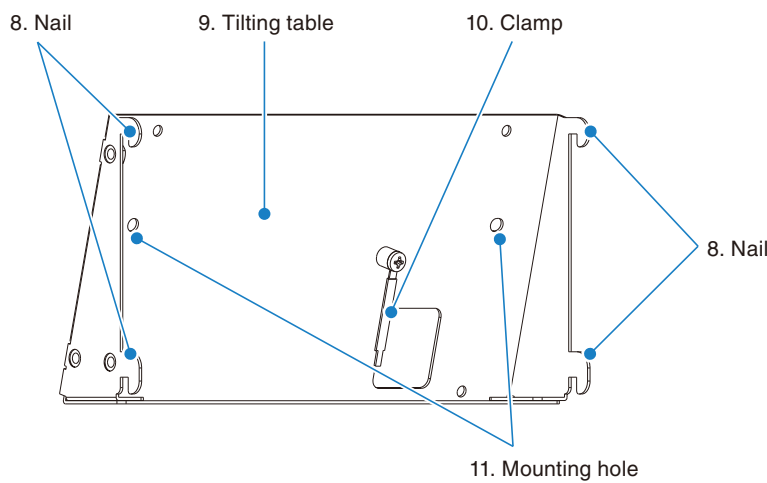

8. NailNails for fixing to the main module (4 places).
9. Tilting tableUse the tilting table (at a 15° tilt angle) to fit the Display Module to main module.
10. ClampClamp that secures the monitor connection cable.
11. Mounting holeThreaded hole for fixing to the Display Module.

SSD Module (GL7-SSD): Optional

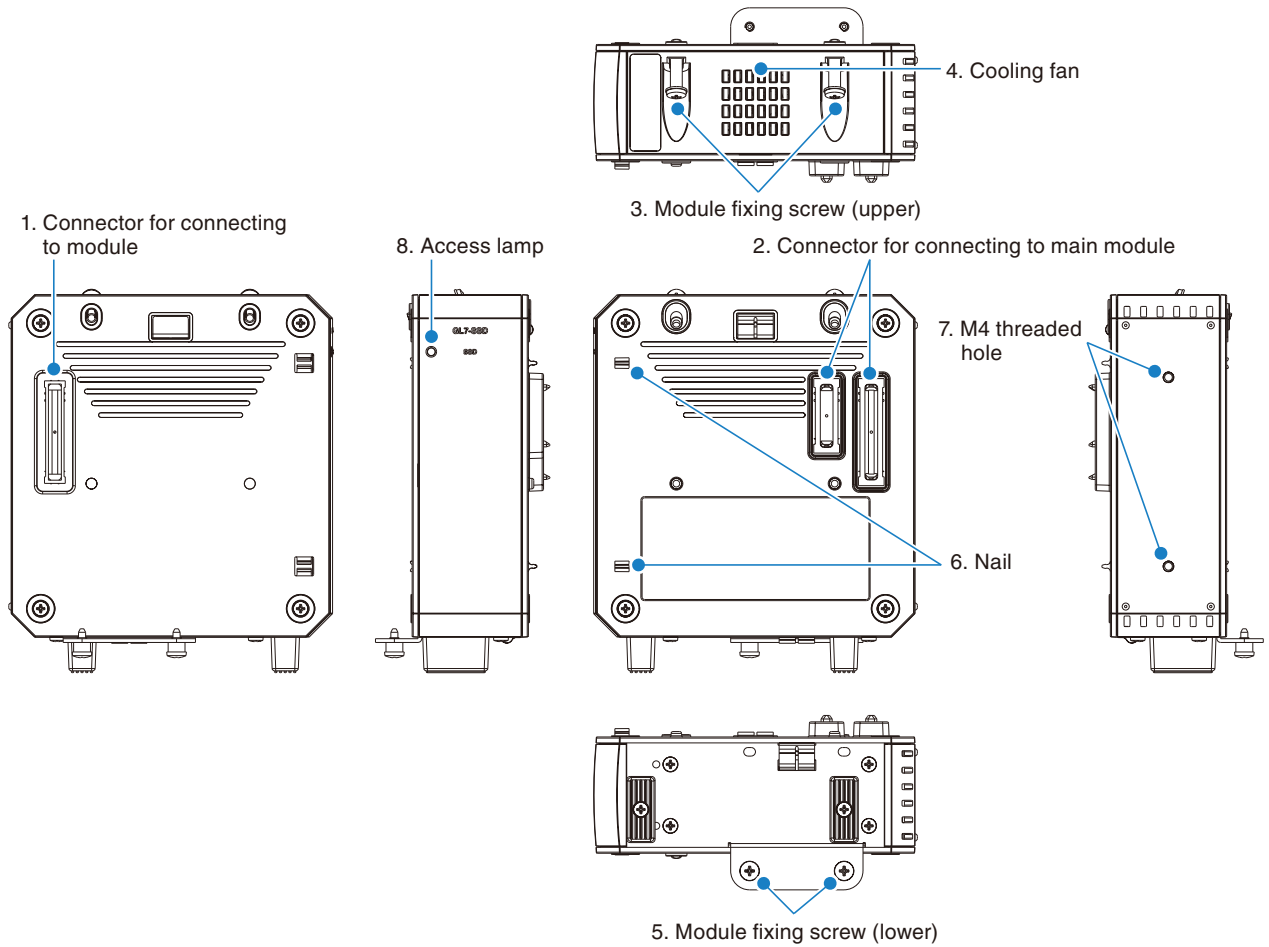

1. Connector for connecting to module
.....Connector for connecting to the various modules.
2. Connector for connecting to main module
.....Connector for connecting to the main module.
3. Module fixing screw (upper)Fixation screw for the adjoining module.
To prevent drop off, please refrain from removing it from the module.
4. Cooling fanFan to cool internally.
5. Module fixing screw (lower).....Fixation screw for the adjoining module.
6. Nail A nail for aiding in positioning when connecting the module.
7. M4 threaded hole.....Use this hole to mount to the panel, etc.
8. Access lamp.....During data access, it lights up green (not lit when normal operation).
* Do not turn of the power during the lamp is lit.

Voltage Module (GL7-V): Optional

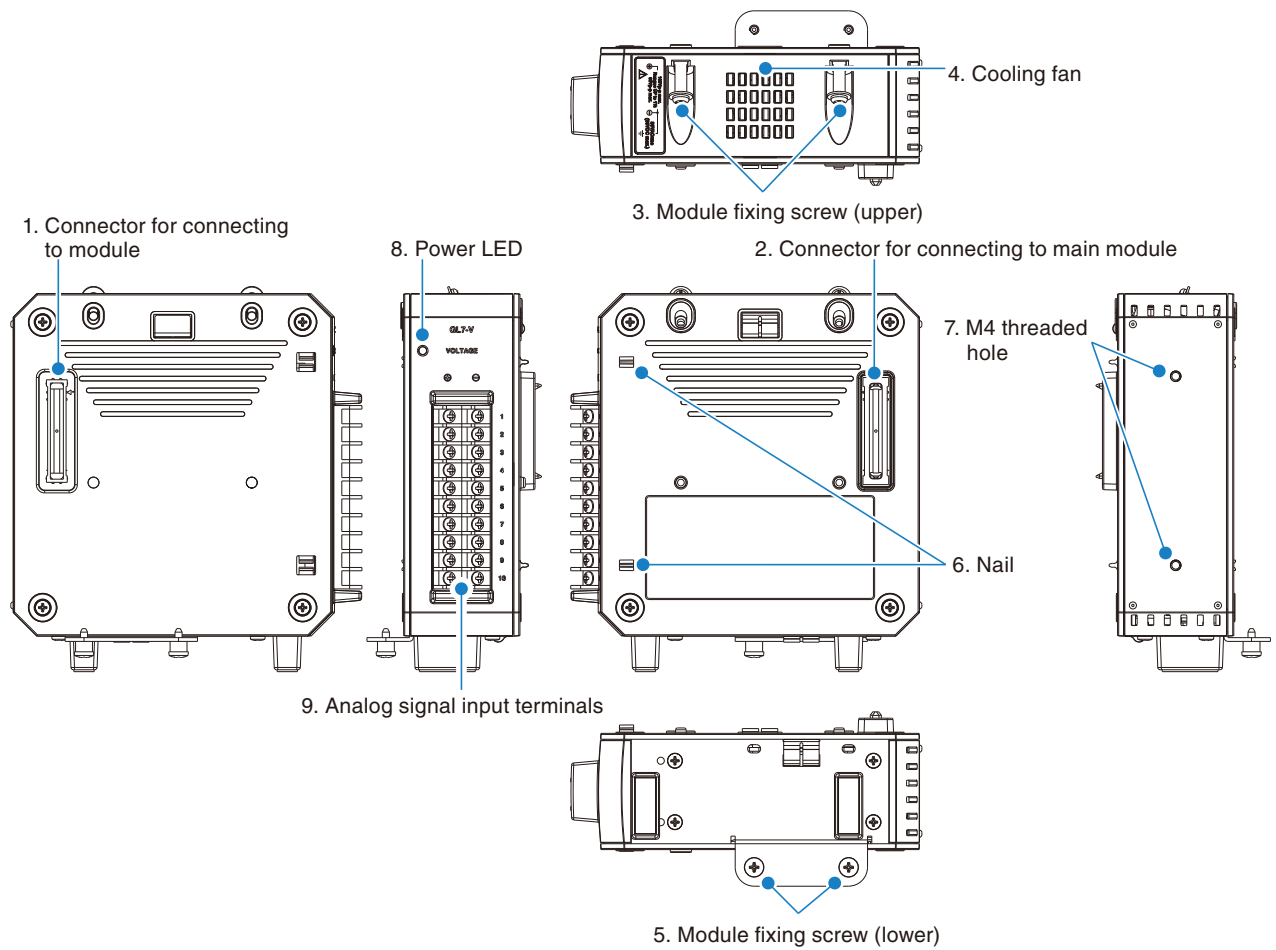

1. Connector for connecting to module
.....Connector for connecting to the various modules.
2. Connector for connecting to main module
.....Connector for connecting to the GL7000 main module or various modules.
3. Module fixing screw (upper)Fixation screw for the adjoining module.
4. Cooling fanFan to cool internally.
5. Module fixing screw (lower).....Fixation screw for the adjoining module.
6. NailA nail for aiding in positioning when connecting the module.
7. M4 threaded hole.....Use this hole to mount to the panel, etc.
8. Power LEDThe Power LED will light up green when the power has been turned on and the module has been recognized.
9. Analog signal input terminals ...Terminal for inputting analog measurements.

High speed voltage Module (GL7-HSV): Optional

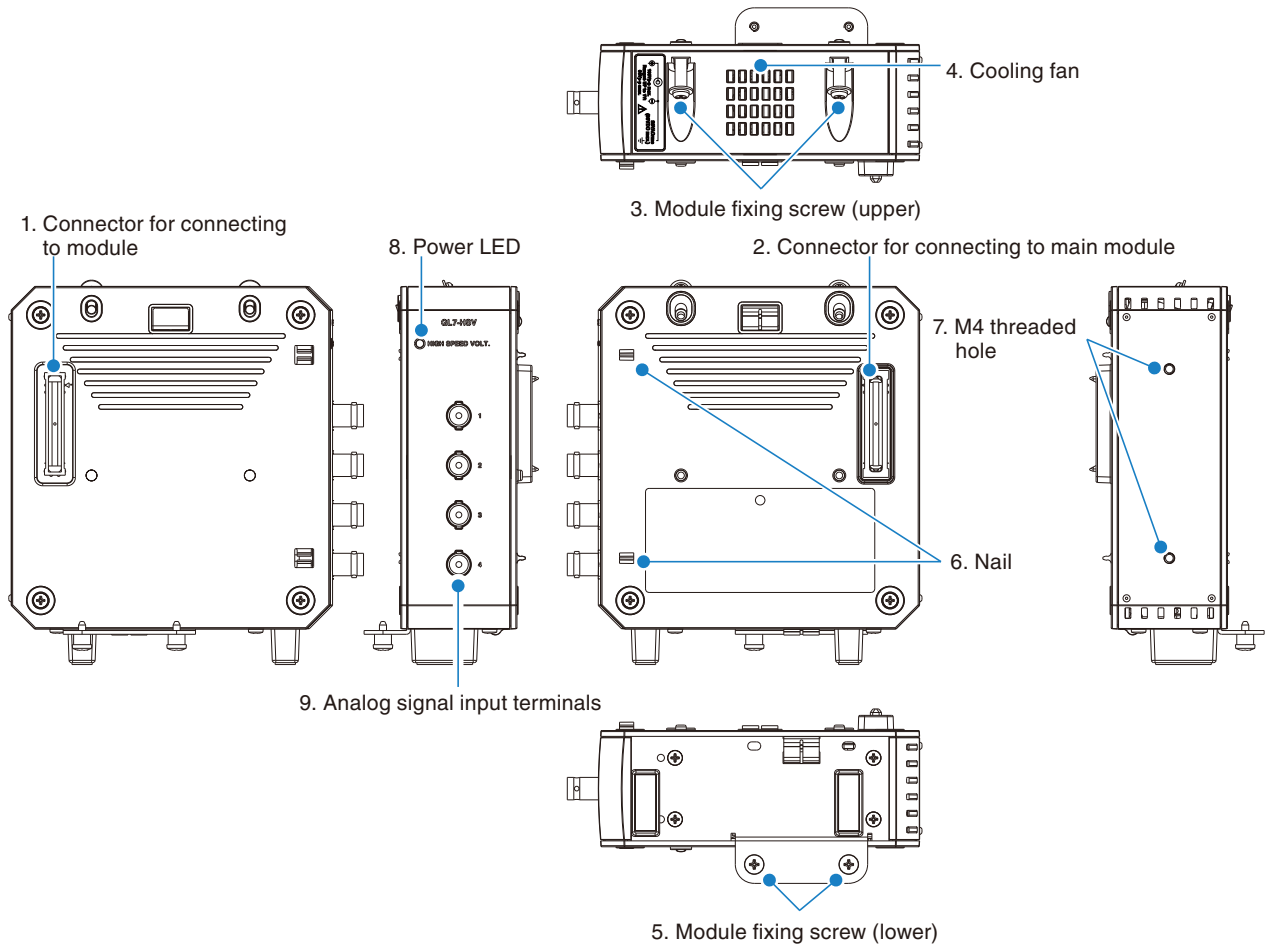

- 1. Connector for connecting to module
.....Connector for connecting to the various modules.
- 2. Connector for connecting to main module
.....Connector for connecting to the GL7000 main module or various modules.
- 3. Module fixing screw (upper)Fixation screw for the adjoining module.
- 4. Cooling fanFan to cool internally.
- 5. Module fixing screw (lower).....Fixation screw for the adjoining module.
- 6. NailA nail for aiding in positioning when connecting the module.
- 7. M4 threaded hole.....Use this hole to mount to the panel, etc.
- 8. Power LEDThe Power LED will light up green when the power has been turned on and the module has been recognized.
- 9. Analog signal input terminals ...Terminal for inputting analog measurements.

Voltage/Temperature Module (GL7-M): Optional

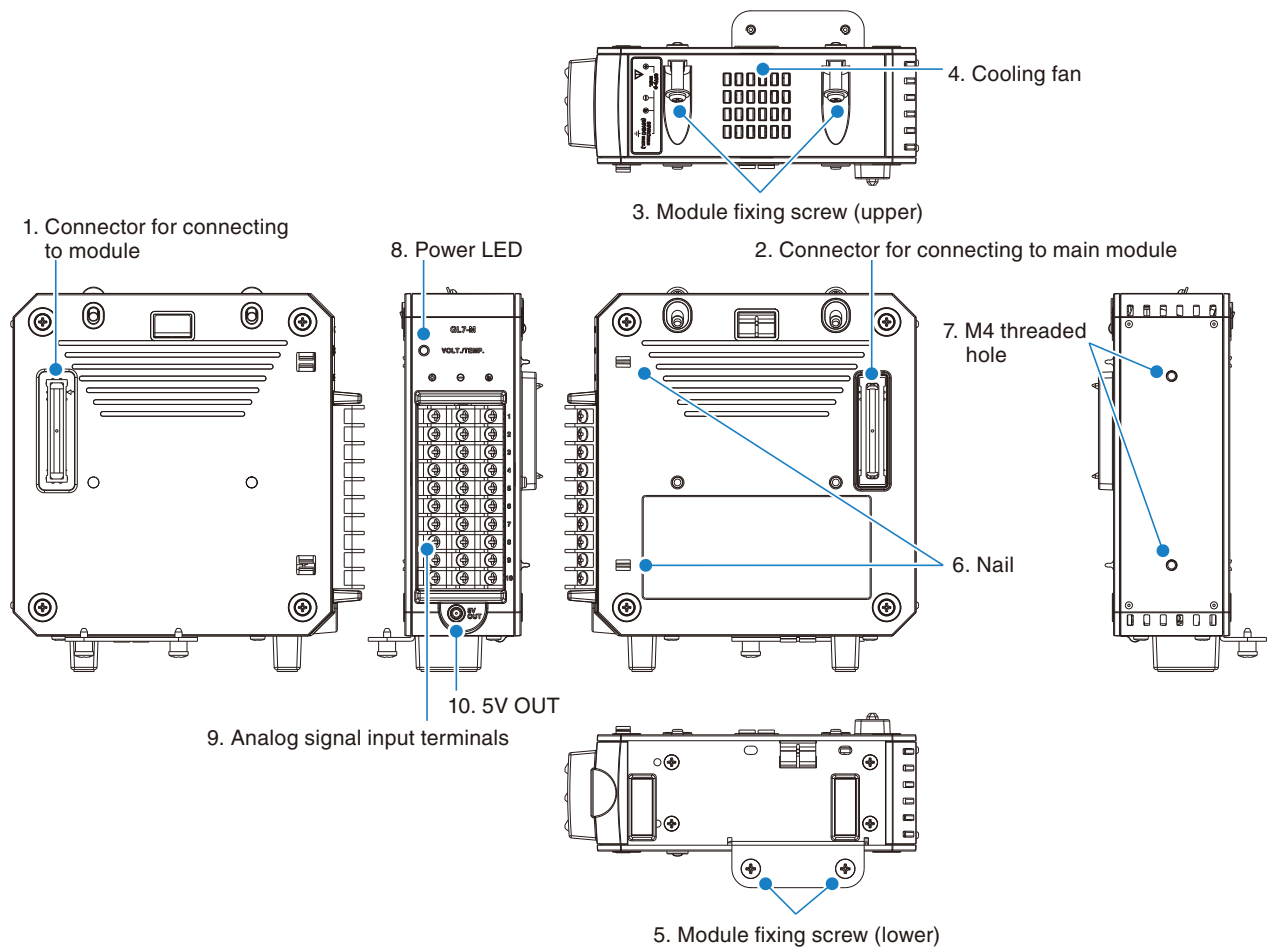

1. Connector for connecting to module
.....Connector for connecting to the various modules.
2. Connector for connecting to main module
.....Connector for connecting to the GL7000 main module or various modules.
3. Module fixing screw (upper)Fixation screw for the adjoining module.
4. Cooling fanFan to cool internally.
5. Module fixing screw (lower).....Fixation screw for the adjoining module.
6. NailA nail for aiding in positioning when connecting the module.
7. M4 threaded hole.....Use this hole to mount to the panel, etc.
8. Power LEDThe Power LED will light up green when the power has been turned on and the module has been recognized.
9. Analog signal input terminals ...Terminal for inputting analog measurements.
10. 5V OUT.....Power for the temperature sensor (optional: B-530).

Logic/Pulse Module (GL7-L/P): Optional

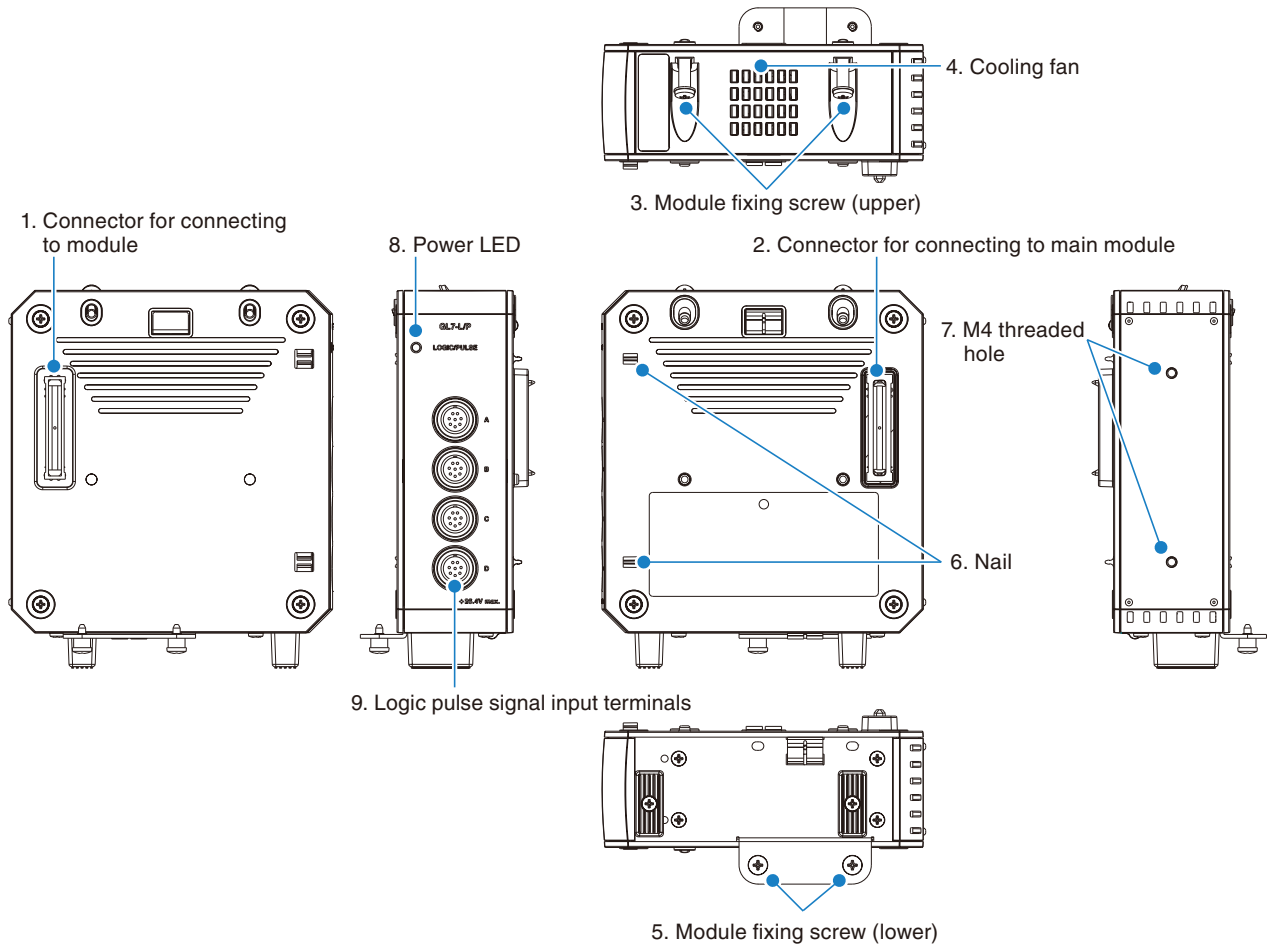

1. Connector for connecting to module
.....Connector for connecting to the various modules.
2. Connector for connecting to main module
.....Connector for connecting to the GL7000 main module or various modules.
3. Module fixing screw (upper)Fixation screw for the adjoining module.
To prevent drop off, please refrain from removing it from the module.
4. Cooling fanFan to cool internally.
5. Module fixing screw (lower).....Fixation screw for the adjoining module.
6. NailA nail for aiding in positioning when connecting the module.
7. M4 threaded hole.....Use this hole to mount to the panel, etc.
8. Power LEDThe Power LED will light up green when the power has been turned on and the module has been recognized.
9. Logic pulse signal input terminals
.....Terminal for inputting analog measurements.
Use the sold separately logic/pulse probe (RIC-10A) as input cable.

High voltage Module (GL7-HV): Optional

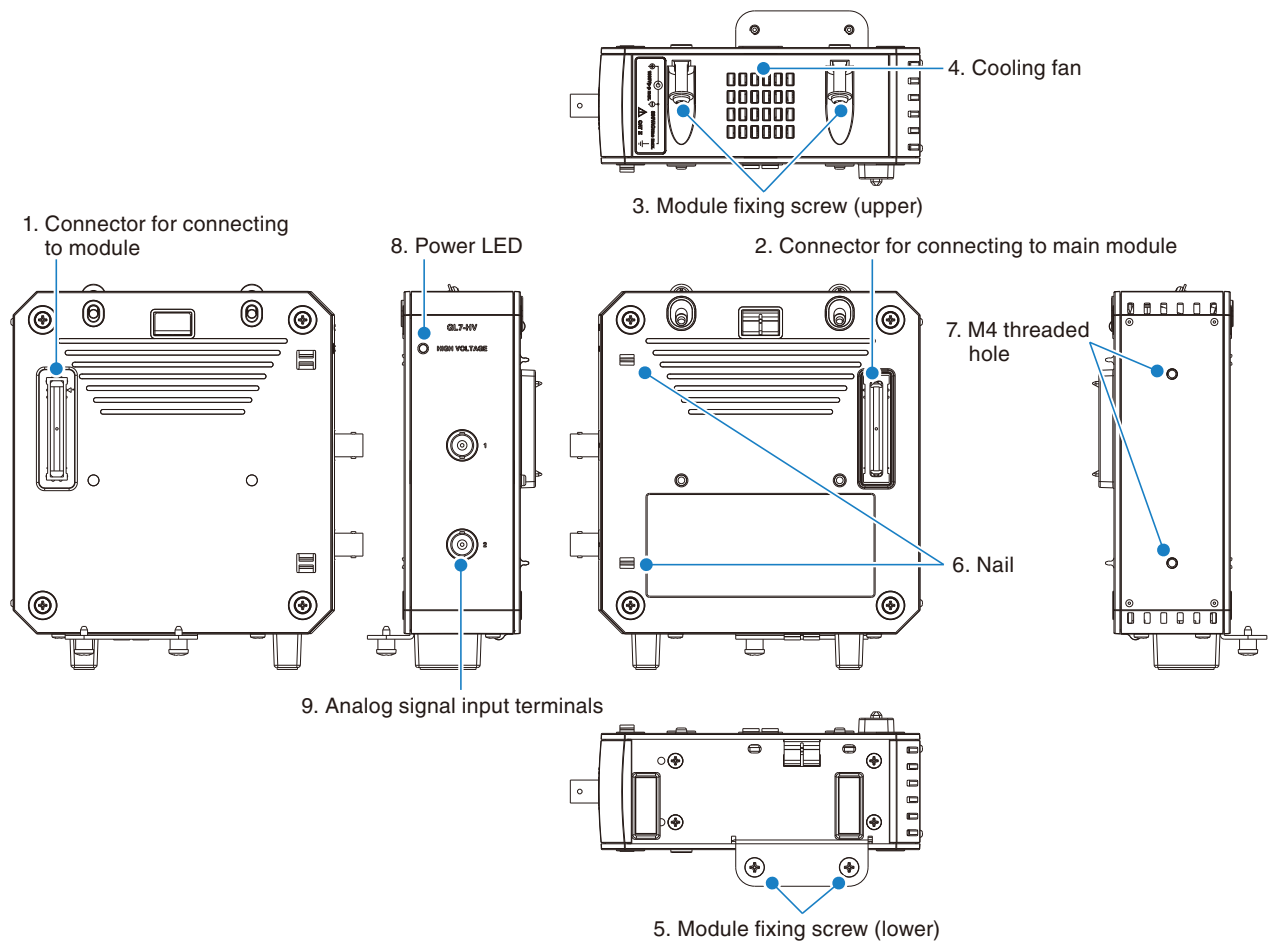

1. Connector for connecting to module
.....Connector for connecting to the various modules.
2. Connector for connecting to main module
.....Connector for connecting to the GL7000 main module or various modules.
3. Module fixing screw (upper)Fixation screw for the adjoining module.
4. Cooling fanFan to cool internally.
5. Module fixing screw (lower).....Fixation screw for the adjoining module.
6. NailA nail for aiding in positioning when connecting the module.
7. M4 threaded hole.....Use this hole to mount to the panel, etc.
8. Power LEDThe Power LED will light up green when the power has been turned on and the module has been recognized.
9. Analog signal input terminals ...Terminal for inputting analog measurements.

DC Strain Module (GL7-DCB): Optional

<DC Strain Module (GL7-DCB) accessories>

- DC Strain Module: 1 unit
- DSUB (male) connector: 4 pcs.

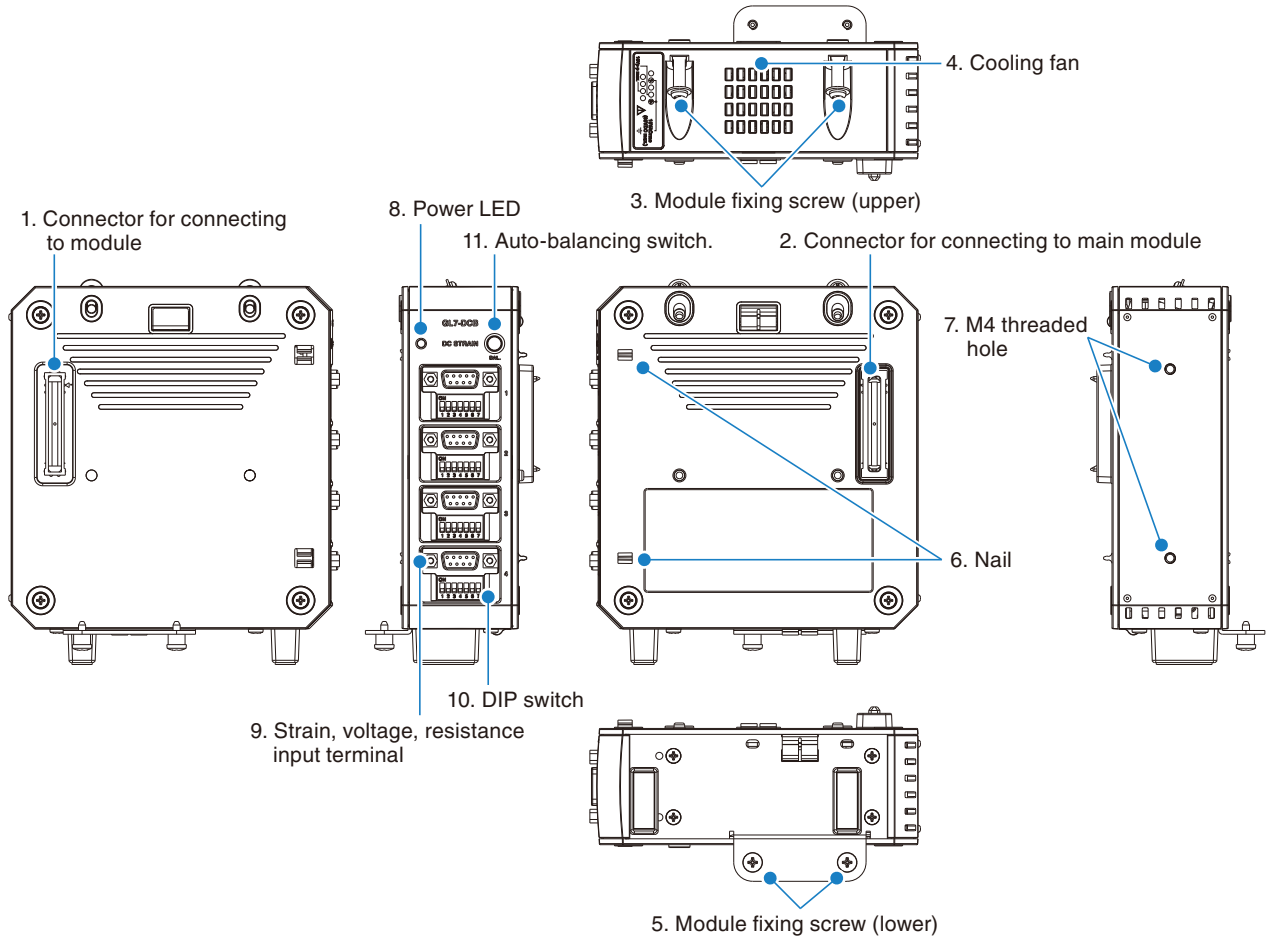

1. Connector for connecting to module
.....Connector for connecting to the various modules.
2. Connector for connecting to main module
.....Connector for connecting to the GL7000 main module or various modules.
3. Module fixing screw (upper)Fixation screw for the adjoining module.
4. Cooling fanFan to cool internally.
5. Module fixing screw (lower)Fixation screw for the adjoining module.
6. NailA nail for aiding in positioning when connecting the module.
7. M4 threaded holeUse this hole to mount to the panel, etc.
8. Power LEDThe Power LED will light up green when the power has been turned on and the module has been recognized.
However, this LED flashes during auto-balancing.
9. Strain, voltage, resistance input terminal
.....Terminal for inputting analog measurements.
10. DIP switchThis is used to switch to strain, voltage or resistance.
11. Auto-balancing switchSet the initial value of the strain to 0 (zero) by pushing the switch.

⚠ CAUTION
 The number of DC strain modules that can be installed is up to 8 modules. If more than 8 modules are installed, the message is displayed when the power is turned.

Charge Module (GL7-CHA): Optional

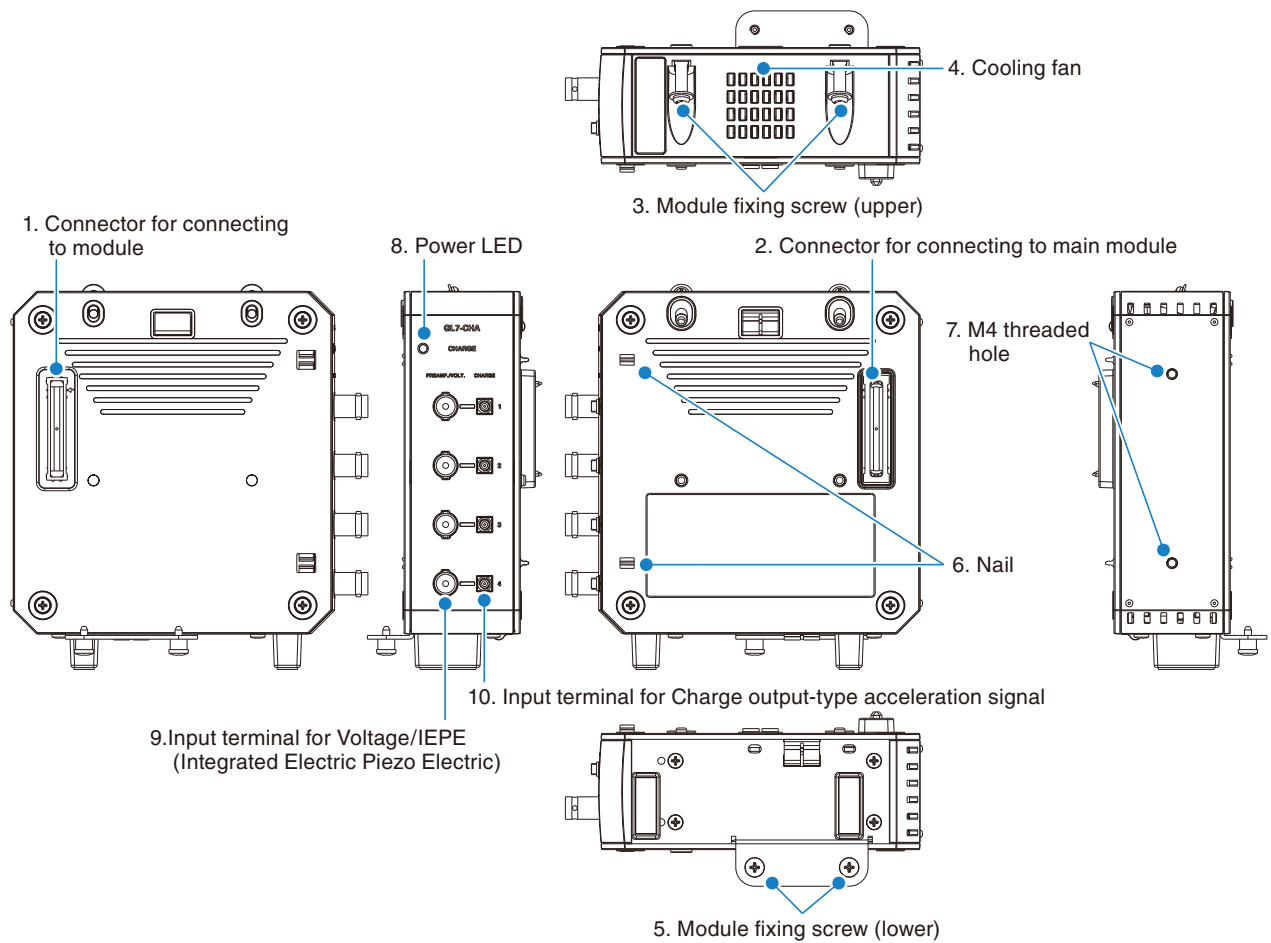

1. Connector for connecting to module
.....Connector for connecting to the various modules.
2. Connector for connecting to main module
.....Connector for connecting to the GL7000 main module or various modules.
3. Module fixing screw (upper)Fixation screw for the adjoining module.
4. Cooling fanFan to cool internally.
5. Module fixing screw (lower).....Fixation screw for the adjoining module.
6. NailA nail for aiding in positioning when connecting the module.
7. M4 threaded hole.....Use this hole to mount to the panel, etc.
8. Power LEDThe Power LED will light up green when the power has been turned on and the module has been recognized.
9. Input terminal for Voltage/IEPE (Integrated Electric Piezo Electric)
.....Terminal for inputting analog measurements.
10. Input terminal for Charge output-type acceleration signal
.....Terminal for inputting analog measurements.

Voltage Output Module (GL7-DCO): Optional

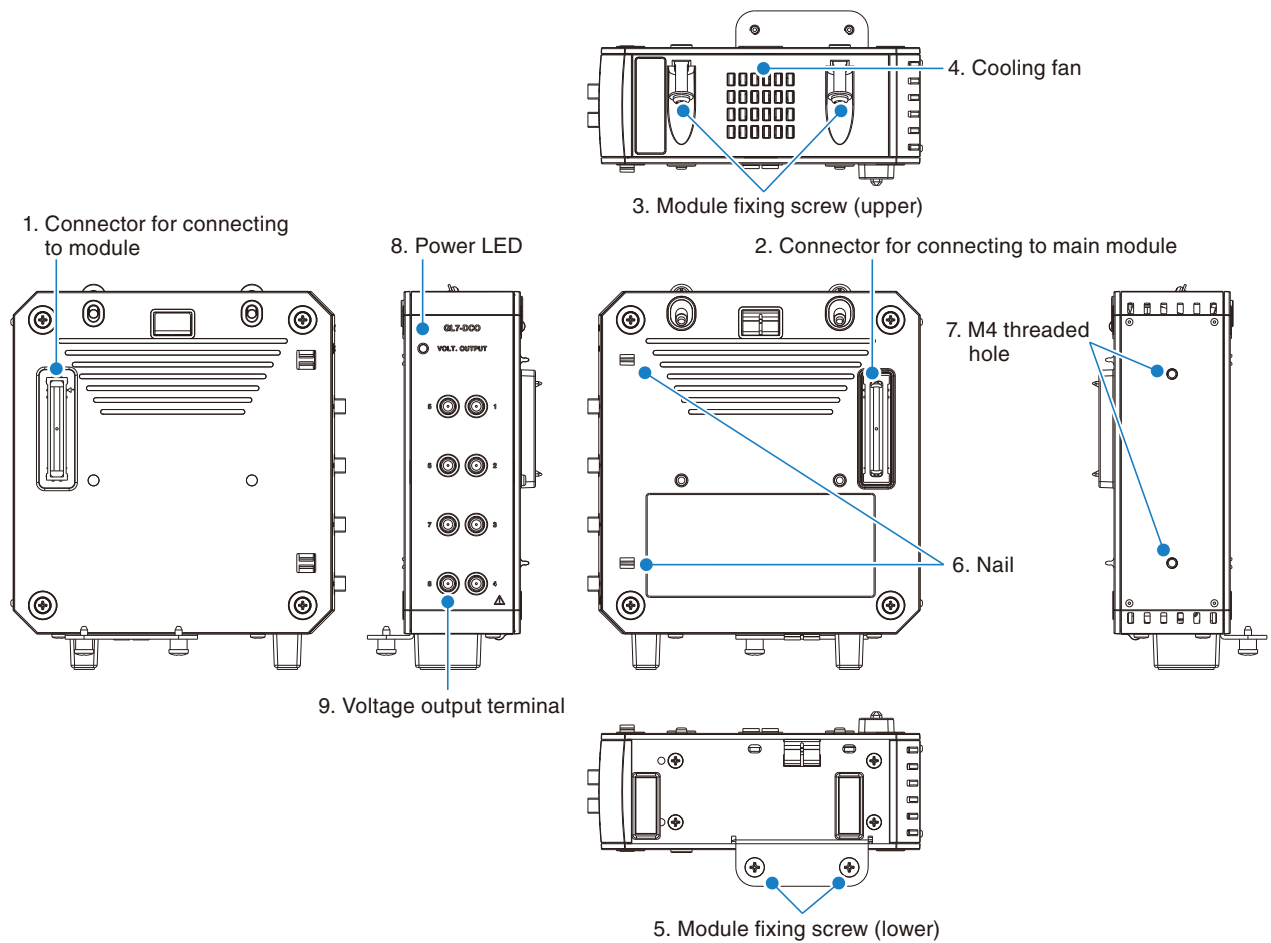

1. Connector for connecting to module
.....Connector for connecting to the various modules.
2. Connector for connecting to main module
.....Connector for connecting to the GL7000 main module or various modules.
3. Module fixing screw (upper)Fixation screw for the adjoining module.
4. Cooling fanFan to cool internally.
5. Module fixing screw (lower).....Fixation screw for the adjoining module.
6. NailA nail for aiding in positioning when connecting the module.
7. M4 threaded hole.....Use this hole to mount to the panel, etc.
8. Power LEDThe Power LED will light up green when the power has been turned on and the module has been recognized.
9. Voltage output terminalTerminal for outputting analog voltage. (All channels common ground)

2.7 Installing and removing the Module

This section describes how to install the module. When removing the module, reverse the installing procedure.

⚠ CAUTION

- When installing or removing modules, please make sure that the power is turned off.
- When removing a module, please don't remove it by holding the body. If holding the input terminal part etc. when removing the module there is a risk of damaging it.
- Please make sure to install the attached Alarm Module on the end (left side when looked at from the front) of the machine. If the Alarm Module is not connected, sufficient performance may not be obtained.
- Adequate precautions against static electricity must be taken when handling the modules.
- After installation, please make sure to tighten all module fixing screws. Using without tightening the module fixing screws can cause damage to the module.
- Please note that the setting conditions are initialized when changing the configuration of the amplifier module for measurement.
- Since the touch-screen on the main is calibrated when turning on power, do not touch it at power-up.
- When turning on power while touching the touch-panel, the touch panel may not start properly

Installing the Display Module (GL7-DISP: optional) and GL7000

The Display Module has 3 basic configurations when in use.

- A: When installing the main module: Assembled to the main module configuration.
- B: When using the tilting table: Assembled to the main module using the tilting table (at a 15° tilt angle) configuration.
- C: When using the extension cable: Using a commercially available LAN cable and installing the Display Module away from the main module configuration.

A: This explains how to install when mounting themain module

⚠ CAUTION

When installing or removing modules, please make sure that the power is turned off.

- (1) Remove fixation screws from the main module (2 places on the side)
 - * Use the removed screw to secure the Display module.

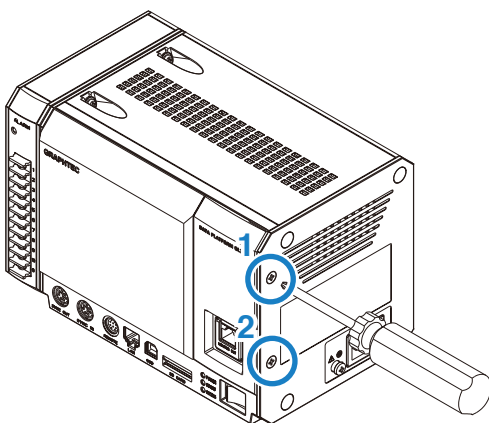

- (2) Pull the nail on the upper-right side of the face cover, and remove the face cover.

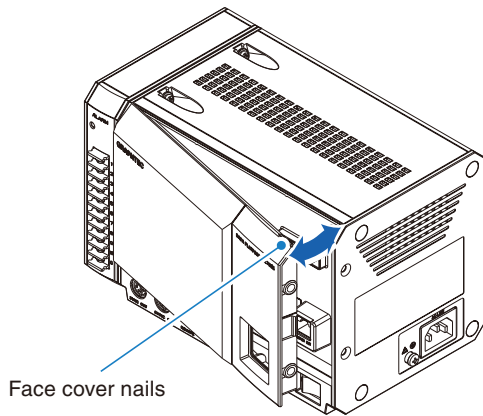

- (3) Join the nails on the back of the Display Module with the inset part of the main module, and push it in.

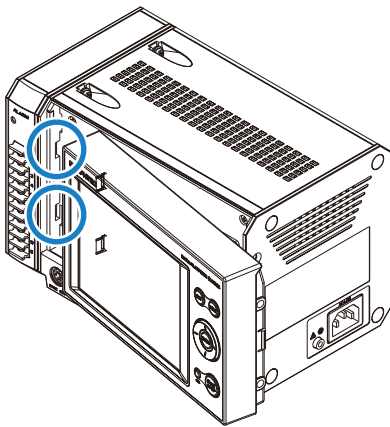

- (4) Join the Display Module with the module connector, and insert into the main module.

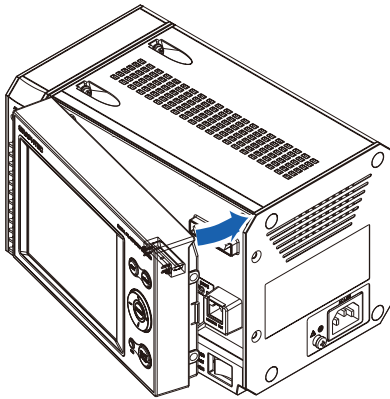

- (5) Attach the fixation screws of the main module (2 places on the side). Using the screw removed when the face cover is removed, secure it.

CHECKPOINT

During installation, a 4kgf/cm screw tightening torque is recommended.

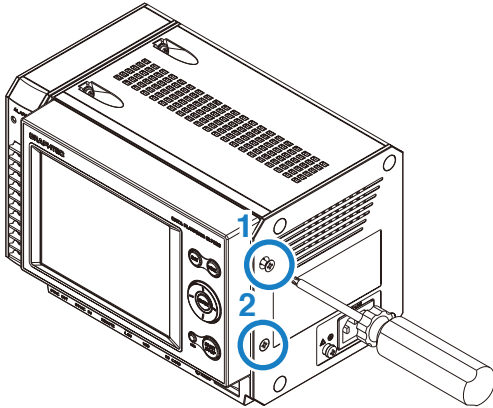
**CAUTION**

- Since the touch-screen on the main module is calibrated when turning on power, do not touch it at power-up.
- When turning on power while touching the touch-panel, the touch panel may not start properly.

B: This explains how to attach the tilting table for use.**CAUTION**

When installing or removing modules, please make sure that the power is turned off.

(After removing the main module face cover)

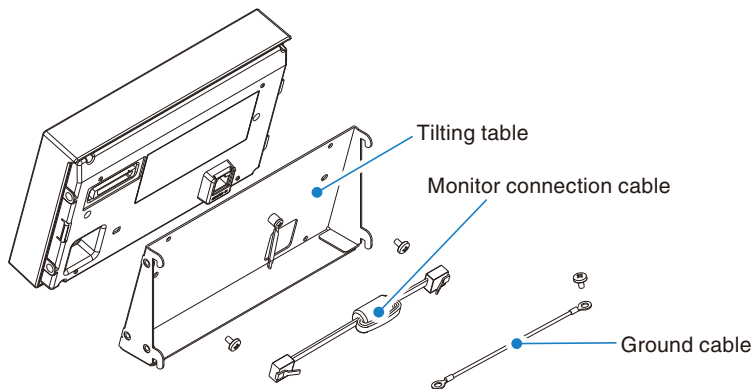

- (1) Install the monitor connection cable with the clamp on the tilting table.



- (2) Attach the Display Module to the tilting table with the attached fixation screws (2 places)

CHECKPOINT 

During installation, a 4kgf/cm screw tightening torque is recommended.

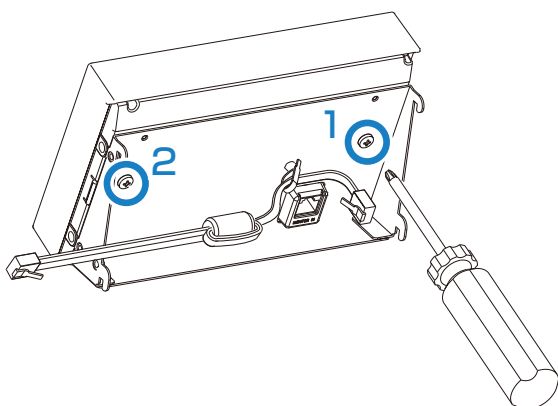

- (3) Connect the connector of the monitor connection cable to the monitor in connector of the Display Module.

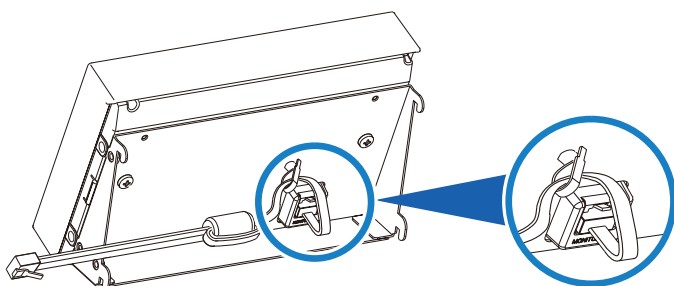

- (4) Connect the monitor connection cable to the monitor out connector of the main module and attach the 4 point nails on the tilting table by fixing them to inset part of the main module (4 places).

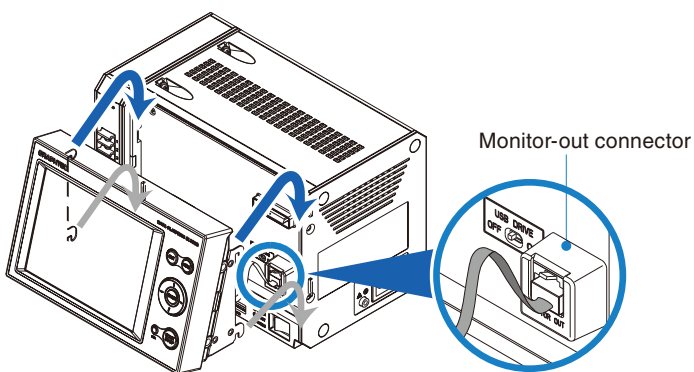

- (5) Attach the fixation screws on the main module (2 places on the side). Using the screw removed when the face cover is removed, secure it.

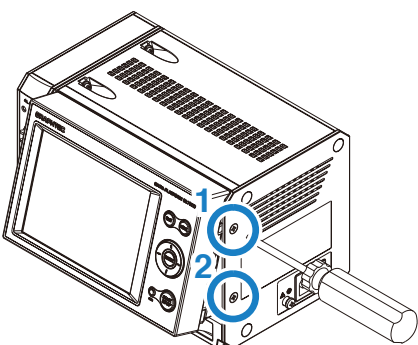

- (6) Attach the ground cable to the main module (GND terminal) with the fixation screws attached to the tilting table.

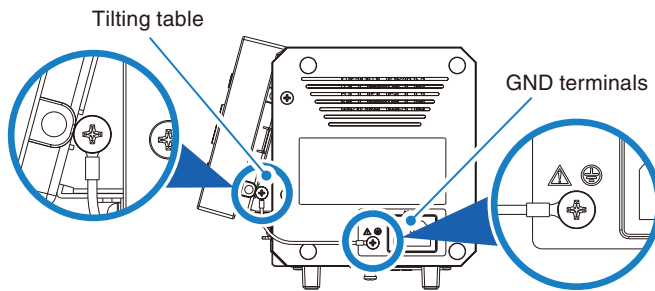

CHECKPOINT

- During installation, a 4kgf/cm screw tightening torque is recommended.
- If the ground cables included with the Display module is not connected, sufficient performance may not be obtained.
- To reduce the impact of noise, always connect the power cable with ground connection. For details, see "2.9 Connecting the Power Cable and Turning on the Power" on page 2-28.

CAUTION

- Since the touch-screen on the main module is calibrated when turning on power, do not touch it at power-up.
- When turning on power while touching the touch-panel, the touch panel may not start properly.

C: This explains installation when extending cables.

CAUTION

When installing or removing modules, please make sure that the power is turned off.

(After the main module's face cover is mounted)

- (1) Connect the monitor out contact on the main module and the monitor in contact on the Display Module with a commercially available LAN cable.

* Please note the specifications of the LAN cable you use.

[LAN Cable specifications]

- Type: Straight cable
- Category: CAT5 or above
- Cable length: 10 m or less

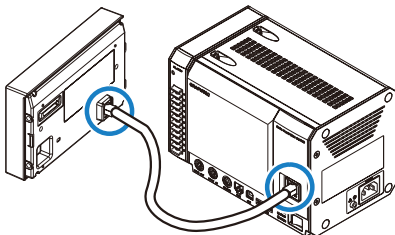

CAUTION

- Please do not connect a LAN cable with the monitor in connector of the Display Module and the LAN connector of the main module.
- Please do not via HUB or a network between monitor in connector of the Display Module and monitor out connector of main module.
- Please use the display module fixed to a board, etc.

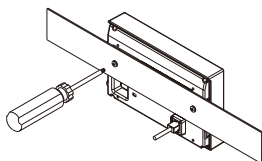

- The screen may have flicker when it is installed to electrically noisy place.

CHECKPOINT

To reduce the impact of noise, always connect the power cable with ground connection. For details, see "2.9 Connecting the Power Cable and Turning on the Power" on page 2-28.

Installing the amplifier module for measurement (optional) and main module

⚠ CAUTION

- When installing or removing modules, please make sure that the power is turned off.
- Please note that the setting conditions are initialized when changing the configuration of the amplifier module for measurement.

(Here, we explain using the Voltage Module as an example)

(1) Remove the module fixing screws (4 places on the upper and lower part) and slide the Alarm Module parallel to the main module in the direction of the arrow.

1. Remove the fixing screws from 2 places on the lower part.
2. Loosen the drop-off prevention screws on 2 places on the upper part.
3. Remove the Alarm Module.

⚠ CAUTION

When installing or removing modules, please make sure that the power is turned off.

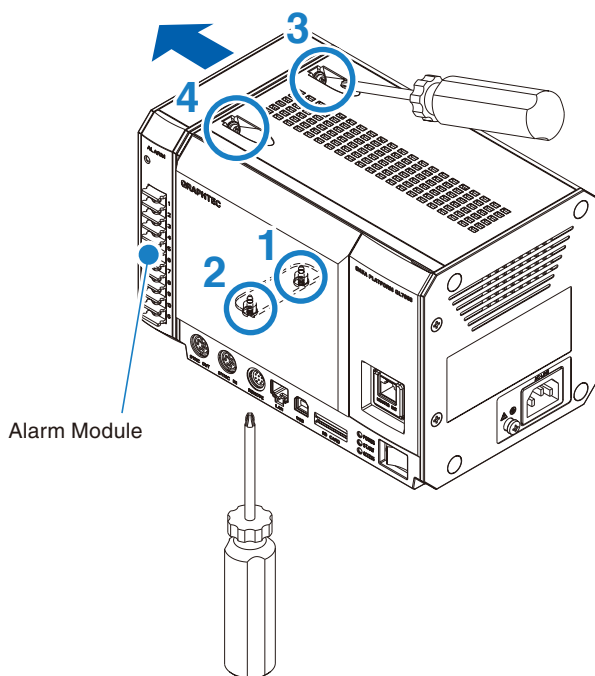

(2) Remove the Voltage module's fixation screws (2 places on the lower part)

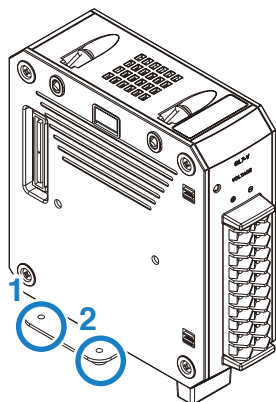

- (3) Connect the connector by sliding it parallel to the main module.

⚠ CAUTION

Slide it in the direction of the arrow. If you pry it at an angle there is a risk of damaging the nail.

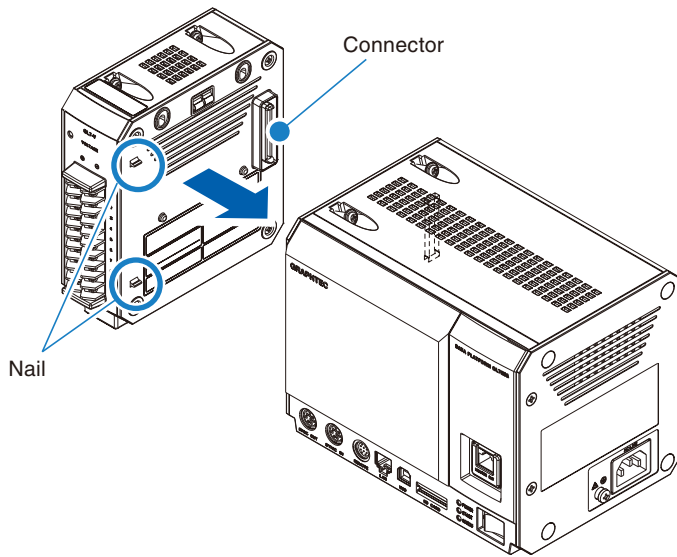

- (4) Fix the voltage module and the main module in place with the screws (4 places on the upper and lower part).

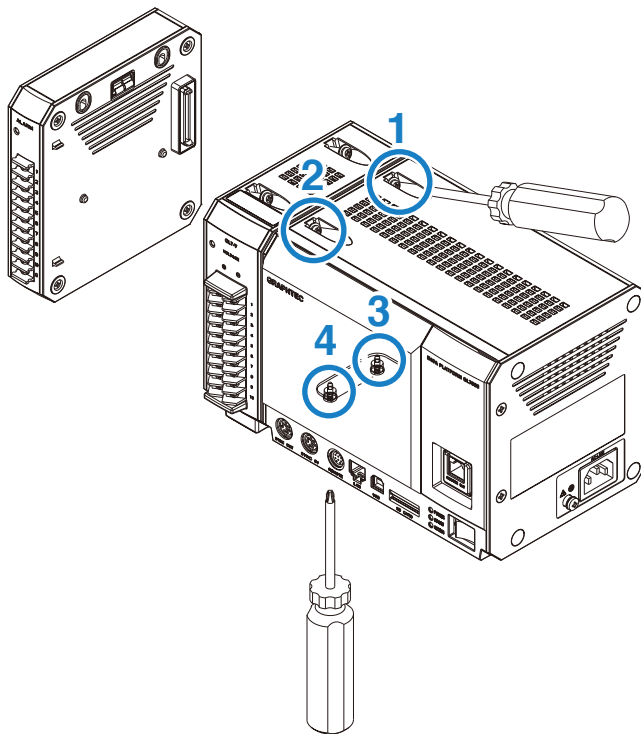

- (5) Connect the connector by sliding the Alarm module parallel to the GL7000 main module to the last part.

⚠ CAUTION

Slide it in the direction of the arrow. If you pry it at an angle there is a risk of damaging the nail.

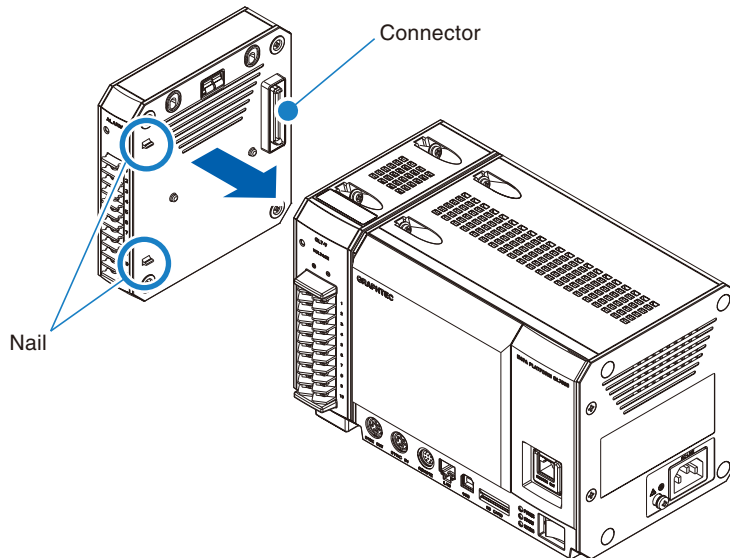

- (6) Secure the Alarm module with the screws (4 locations upper/lower).

CHECKPOINT

During installation, a 4kgf/cm screw tightening torque is recommended.

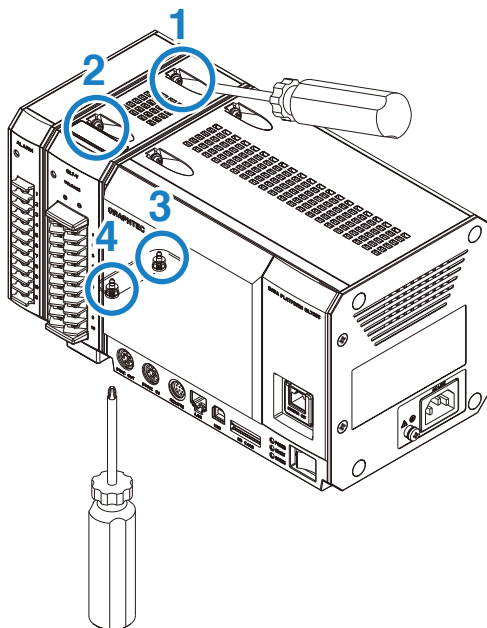

When installing multiple modules

Install 1 module at a time according to the procedures above.
Finally, make sure to tighten with screws before installing the next Module.

Precautions to install SSD Module

The SSD Module is used by installing it on the main module together with other measuring modules. The SSD module is installed in the same way as other Measuring Amplifier modules, but please make sure to connect it to the GL7000.

< Example of installing >

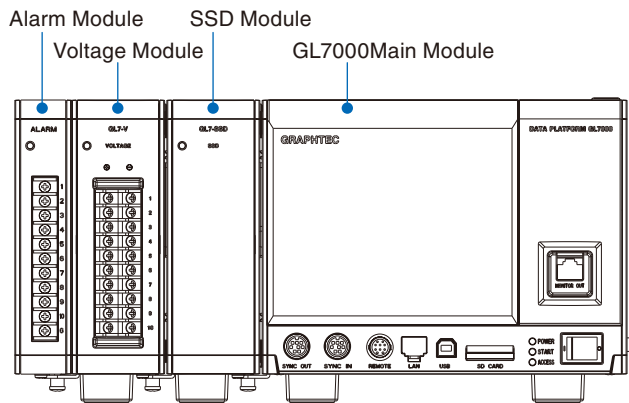

2.8 Installing

Installation location

When installing to the instrumentation panel, please note the following.
 When using on a desk, please refer to "Configuration When in Use" (P1-4).

A well-ventilated location

In order to prevent the temperature from rising inside the machine, please install it in a well-ventilated location. The machine has ventilators and cooling fan exhaust vents. Please do not block these ventilators and exhaust vents.

Please allocate more space than the specified dimensions. (Please refer to "Installation space".)

Installation space

Top view

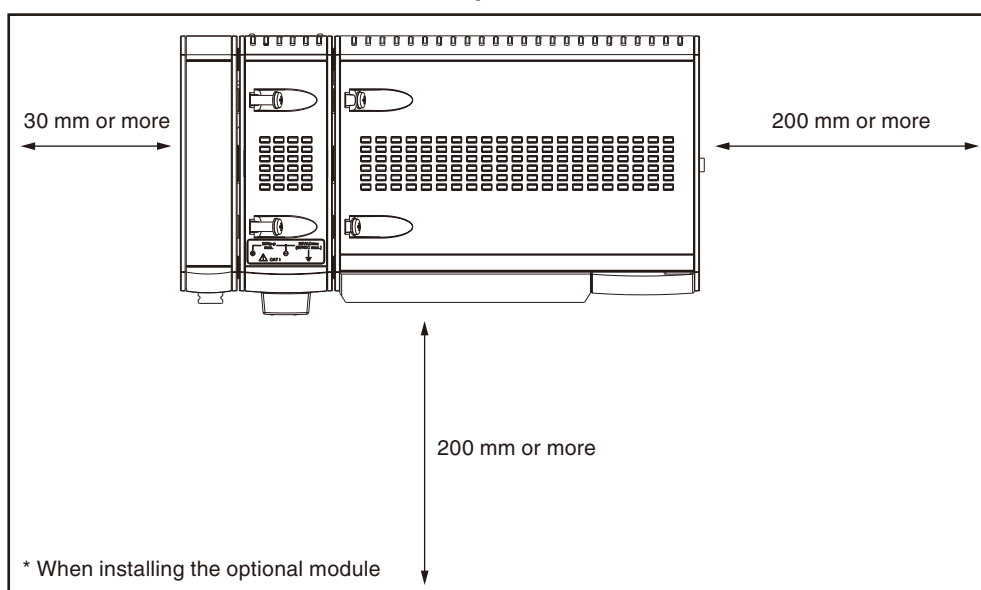

Front view

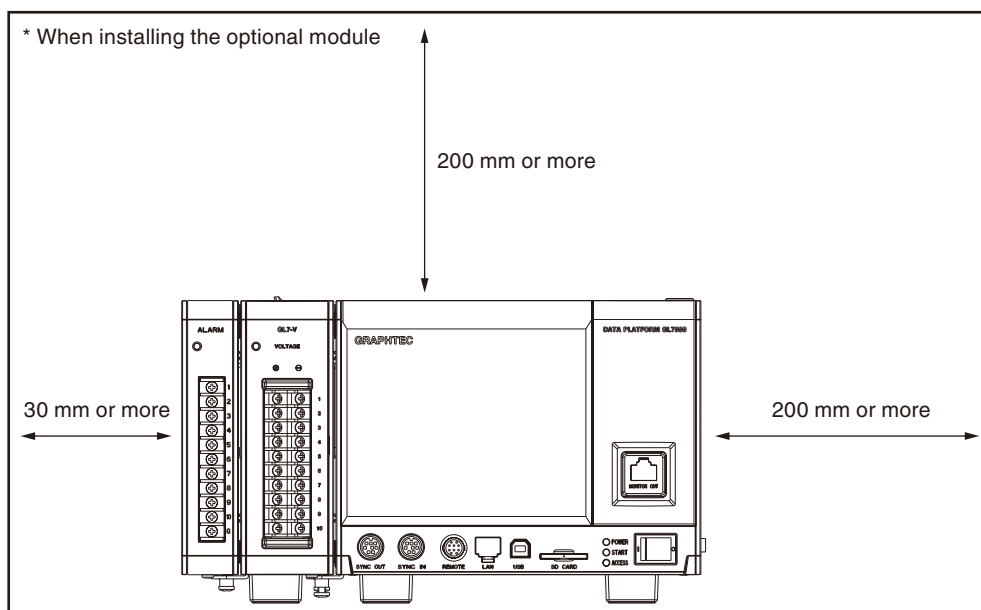

A location with a low amount of mechanical vibrations

Please install in a location with a low amount of mechanical vibrations.

A horizontal location

When installing the machine, please make sure that it's horizontal and doesn't lean to any side.

⚠ CAUTION

Condensation may be caused by moving from a location with a low temperature and humidity to one with high temperature and humidity, or by sudden temperature changes.

Furthermore, during thermocouple input, measurement errors may be yielded. In these cases, use the machine after letting it get accustomed to the surrounding environment for 1 and a half hour or more.

Please do not install in locations such as those listed below.

- **Outdoors**
- **Close to locations with direct sunlight or heaters.**
Please choose a place with a low amount of temperature changes and with a normal temperature (23_) to install it in.
- **Locations with lots of oily smoke, steam, humidity, dust, and corrosive gas.**
Oily smoke, steam, humidity, dust, and corrosive gas have a bad effect on the machine. Please avoid installing the machine in locations where these are abundant.
- **Close to electromagnetic field generation sources**
Please avoid putting tools that give off magnetism and magnets close to the machine.
If the machine is used close to an electromagnetic field generation source, it may cause measurement errors.

How to install (GL7000 and amplifier module, etc.)

When fixing to the surface of an instrumentation panel, before installing please install the modules and check the screws.

Regarding how to install the Module, please refer to "2.7 Installing and removing the Module".

Furthermore, please note the following when installing.

- Please use M4 screws (length: sheet thickness +6 mm).
- Please make sure to install it on a strong wall.
- For your safety, don't install with too much force.

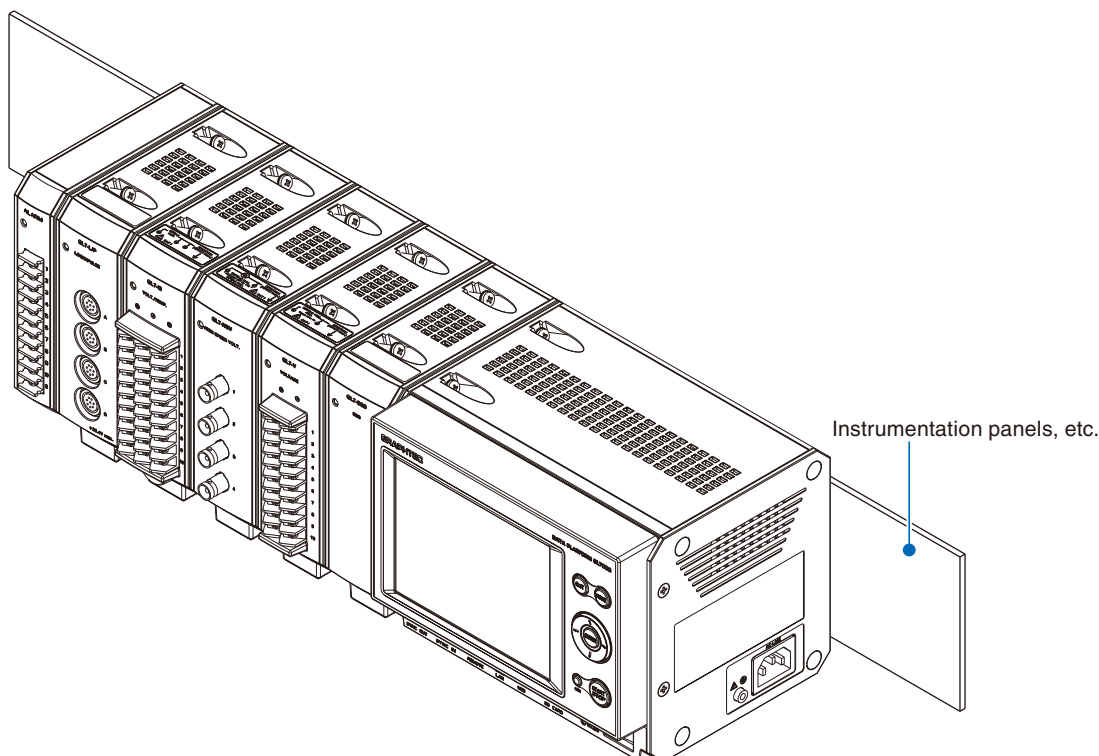

2.9 Connecting the Power Cable and Turning on the Power

This section describes connecting the power cable and turning on the power.

⚠ CAUTION

Before turning on the power supply, make sure that all the modules you use are installed. If the module is installed while the power is on, GL7000 may be damaged.

When using AC power

(1) Please insert the power cable into the AC power connector and the other side into an electrical outlet.

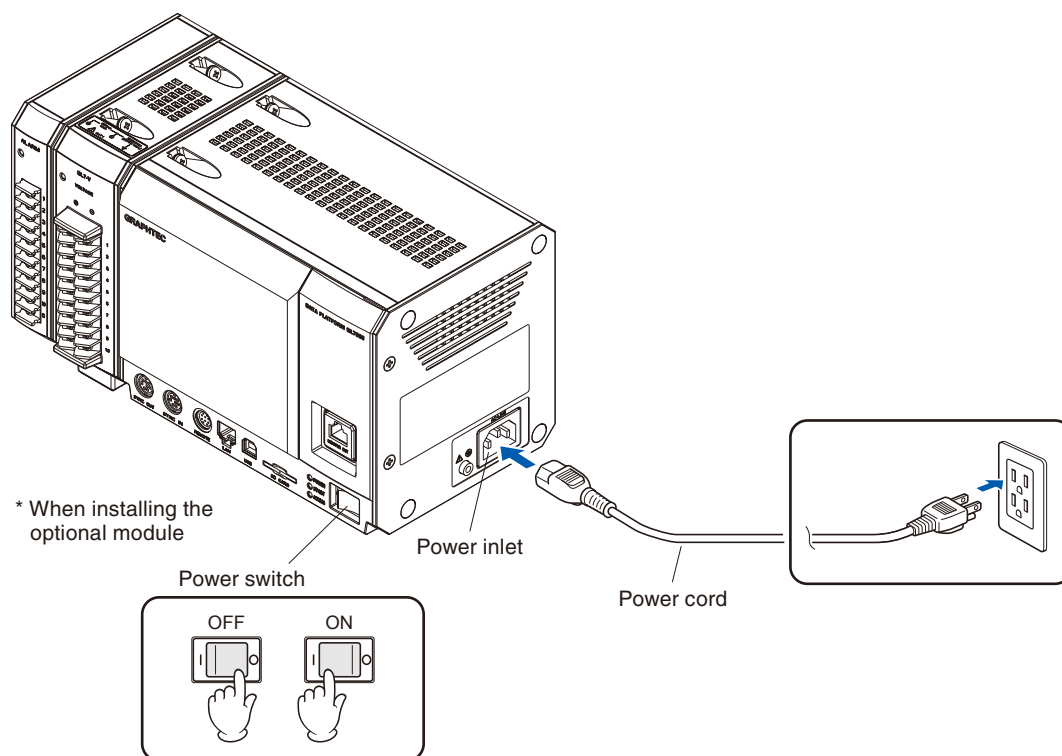

(2) If the power switch is set to ON, the power is turned on.

⚠ CAUTION

- After referring to the safety precautions, please make sure to connect the GND terminal. Also, please connect it even when connecting to other machines using a common GND level.
- The machine is an AC100V/AC200V automatic change system. Please make sure to use a power cord which complies with standards.
- When turning on the power in the state the Amplifier module has not been installed, GL7000 starts up as if one pseudo-voltage module (GL7-V) is installed.

Connecting to the GND terminal

The GND terminal is used when the power cord cannot be grounded and when the GND level is shared with other equipment.

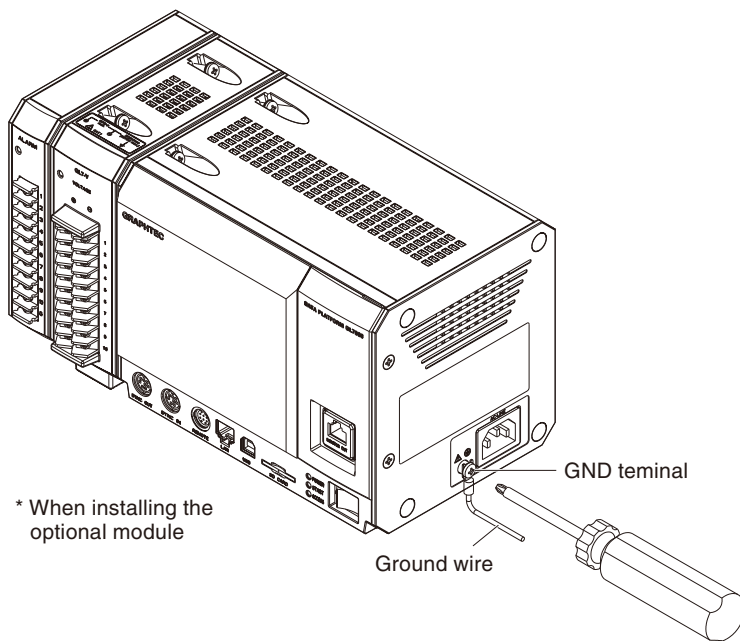

⚠ CAUTION

- In order to prevent an electric shock and a fire, please be sure to ground using a GND terminal.
 - For grounding, use a ground wire with a diameter of at least 0.75 mm^2 .
-

2.10 How to Connect to Analog Signal Input Terminal and Precautions

This explains how to connect the analog signal input terminal.

(1) Voltage Module (GL7-V: Optional)

This explains how to connect the input cable.

⚠ WARNING

During wiring, confirm that the signal's supply source is turned OFF to prevent electrical shocks.

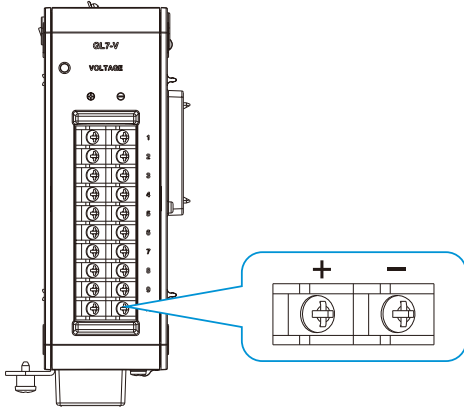

+High-voltage terminal (Terminal for inputting the high-voltage side of the input signal)

-Low voltage terminal (Terminal for inputting the low-voltage side of the input signal)

Direct voltage input

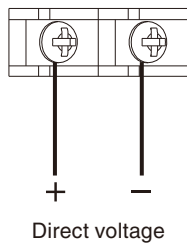

Current input

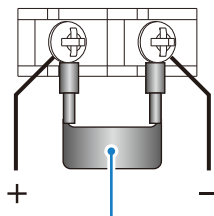

Shunt resistance

Example: In the case of 4-20 mA, apply 250Ω ($\pm 0.1\%$) and measure in the 1-5 V range.

* For shunt resistance, we recommend the use of the optional B-551.

⚠ CAUTION

To avoid break-downs or short-circuiting accidents, please make sure to abide by the items written below.

● Maximum input voltage

- In case the input voltage exceeds the specifications, the circuit at the input part will break down so even if the input voltage exceeds the specifications only for an instant, please don't input.
- Please take care that no static electricity is applied on the analog signal input terminal.

<Input terminal +/- terminal interval (A etc. on the figure right)>

Maximum input voltage : 100 mV to 1 V range 60Vp-p
: 2 V to 100 V range 100Vp-p

<Input terminal (-)/Input terminal (-) interval (B etc. on the figure right)>

Maximum input voltage : 60Vp-p
Withstand voltage : 1000Vp-p/1minute

<Input terminal (-)/GND terminal interval C etc. on the figure right)>

Maximum input voltage : 60Vp-p
Withstand voltage : 1000Vp-p/1 minute

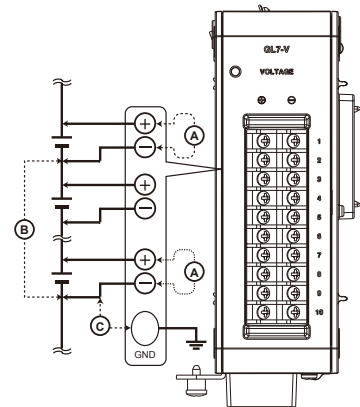

(2) Voltage/Temperature Module (GL7-M: Optional)

This explains how to connect the input cable.

⚠ DANGER

To avoid break-downs or short-circuiting accidents, please make sure to abide by the items written below.

- Do not apply 60Vp-p or higher between the main module (GND terminal) and voltage analog input, and between the analog input channels.

⚠ WARNING

During wiring, confirm that the signal's supply source is turned OFF to prevent electrical shocks.

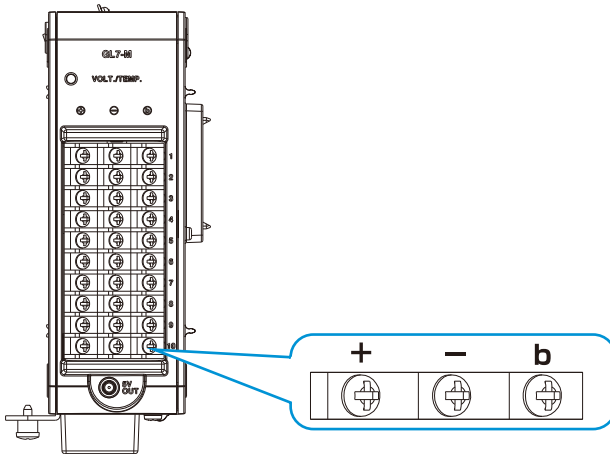

+ High-voltage terminal (Terminal for inputting the high-voltage side of the input signal)

- Low voltage terminal (Terminal for inputting the low-voltage side of the input signal)

b Terminal for dedicated use when connecting the Resistance Temperature Detector.

The + terminal and - terminal are insulated for each channel, but the b terminal is shorted for every internal channel.

Voltage input

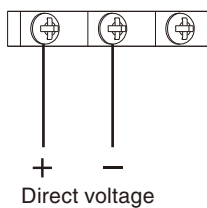

Thermocouple Input

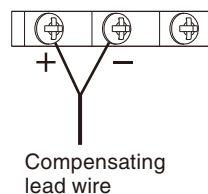

Resistance Temperature Detector input

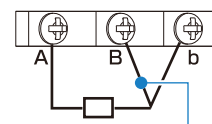

Please use a lead wire resistance of 10Ω or less for 1 line, and make sure to have the same resistance value for all 3 wires.

Current input

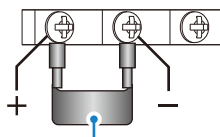

Shunt resistance

Example: In the case of 4-20 mA, apply 250Ω ($\pm 0.1\%$) and measure in the 1-5 V range.

* For shunt resistance, we recommend the use of the optional B-551.

Humidity Sensor Input

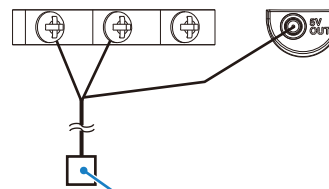

The Humidity Sensor (optional: B-530) 5VOUT is for dedicated use with our B-530.

⚠ CAUTION

To avoid break-downs or short-circuiting accidents, please make sure to abide by the items written below.

● Maximum input voltage

- In case the input voltage exceeds the specifications, the circuit at the input part will break down so even if the input voltage exceeds the specifications only for an instant, please don't input.
- Please take care that no static electricity is applied on the analog signal input terminal.

<Input terminal +/- terminal interval (A etc. on the figure below)>

Maximum input voltage : 60Vp-p

<Input terminal (-)/Input terminal (-) interval (B etc. on the figure below)>

Maximum input voltage : 60Vp-p

Withstand voltage : 350Vp-p/1minute

<Input terminal/GND terminal interval C etc. on the figure below)>

Maximum input voltage : 60Vp-p

Withstand voltage: : 350Vp-p/1 minute

When measuring the voltage

When measuring the temperature

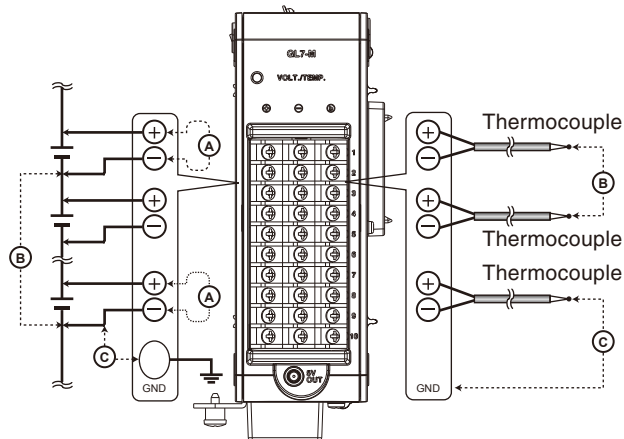

● Input circuit diagram of the analog input (voltage and thermocouple inputs)

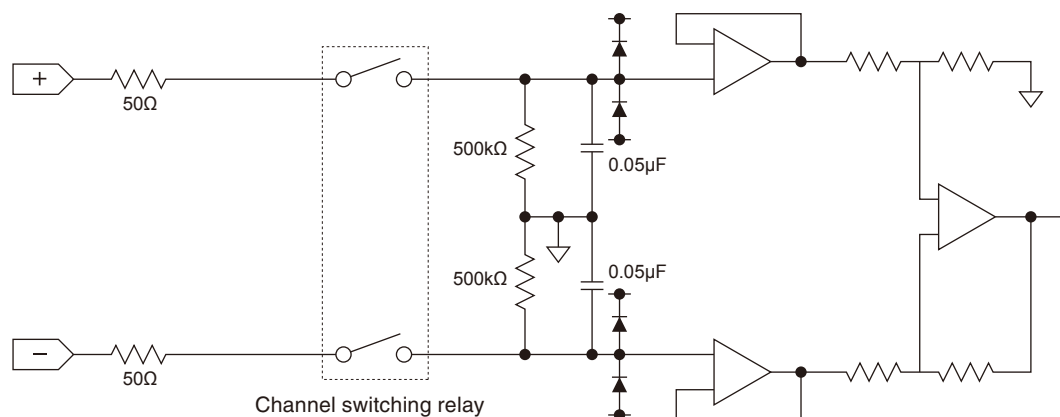

⚠ CAUTION

To help improve the efficiency of noise removal, an input condenser is included.

After measuring voltage, the input will still contain some electricity. Use a separate measuring instrument connected to the + and - terminals beforehand to allow the stored electricity to discharge naturally.

The Voltage and Temperature modules are used for scanning.

When there is no input signal, the input may receive interference from other channels.

You can change input settings to OFF, or short the +/- terminals, to prevent this effect.

When input is configured correctly and a signal is found, there is no interference from other channels.

(3) High Speed Voltage Module (GL7-HSV: Optional)

This explains how to connect the input cable.

⚠ WARNING

During wiring, confirm that the signal's supply source is turned OFF to prevent electrical shocks.

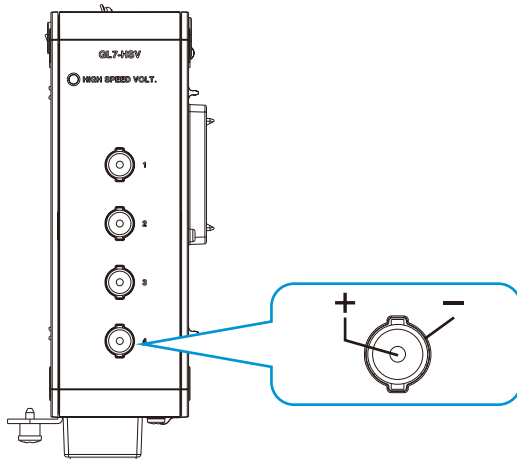

+High-voltage terminal (Terminal for inputting the high-voltage side of the input signal)

-Low voltage terminal (Terminal for inputting the low-voltage side of the input signal)

Voltage input

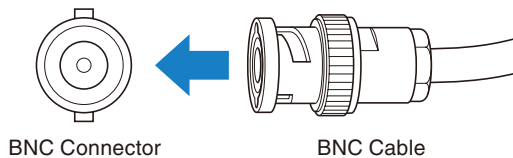

BNC Connector

BNC Cable

⚠ CAUTION

To avoid break-downs or short-circuiting accidents, please make sure to abide by the items written below.

● Maximum input voltage

- In case the input voltage exceeds the specifications, the circuit at the input part will break down so even if the input voltage exceeds the specifications only for an instant, please don't input.
- Please take care that no static electricity is applied on the analog signal input terminal.

<Input terminal +/- terminal interval (A etc. on the figure right)>

Maximum input voltage : 100 mV to 1 V range 60Vp-p
: 2 V to 100 V range 100Vp-p

<Input terminal (-)/Input terminal (-) interval (B etc. on the figure right)>

Maximum input voltage : 60Vp-p
Withstand voltage : 1000Vp-p/1minute

<Input terminal (-)/GND terminal interval C etc. on the figure right)>

Maximum input voltage : 60Vp-p
Withstand voltage : 1000Vp-p/1 minute

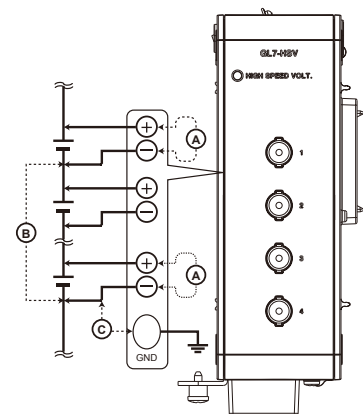

(4) Logic/Pulse Module (GL7-L/P: Optional)

This explains how to connect the input cable.

⚠ WARNING

During wiring, confirm that the signal's supply source is turned OFF to prevent electrical shocks.

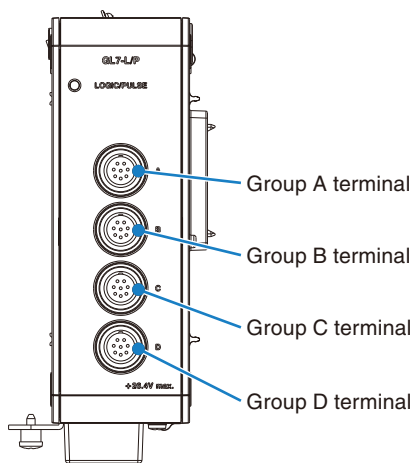

- Group A terminal Logic/Pulse signal group A (CH1 to 4)
- Group B terminal Logic/Pulse signal group B (CH5 to 8)
- Group C terminal Logic/Pulse signal group C (CH9 to 12)
- Group D terminal Logic/Pulse signal group D (CH13 to 16)

- (1) Connect the circular connector side of the RIC-07A (Logic input cable) to the Logic/Pulse signal input terminal.
On the other side, depending on the shape of the measurement, connect a RIC-08A (Alligator clip cable) or a RIC-09A (IC clip cable).

<In the case of RIC-07/08/09>

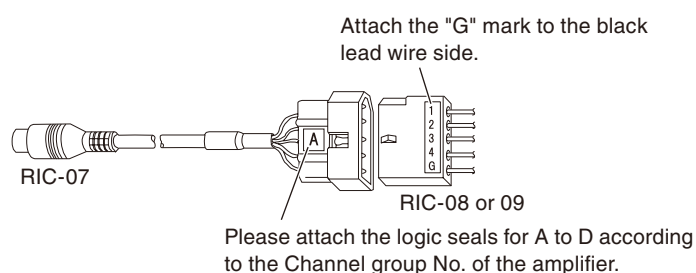

* RIC-07, RIC-08, RIC-09 are optional (sold separately)

<In the case of RIC-07A/08A/09A>

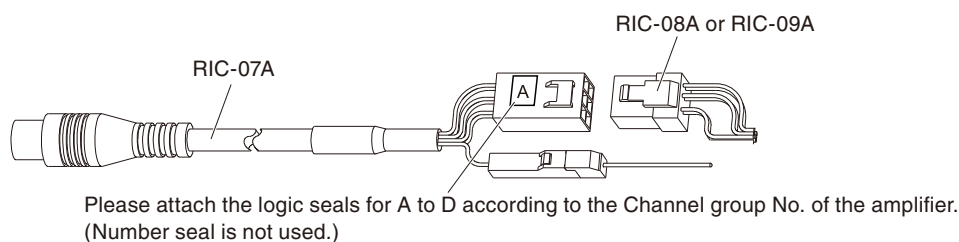

- (2) Connection to the measurement point of the RIC-08A (Alligator clip cable) and the RIC-09A (IC clip cable) is shown in the table below.

Terminal color	Cable color	Channel
Red	Brown	1, 5, 9, 13
	Red	2, 6, 10, 14
	Orange	3, 7, 11, 15
	Yellow	4, 8, 12, 16
Black	Black	Common

- (3) How to remove

<In the case of RIC-07/08/09>

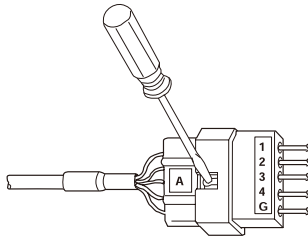

To remove the RIC-07 (Logic input cable) and the RIC-08 (Alligator clip cable), or the RIC-09 (IC clip cable), insert a screwdriver into the connection and remove it by loosening the indentation.

<In the case of RIC-07A/08A/09A>

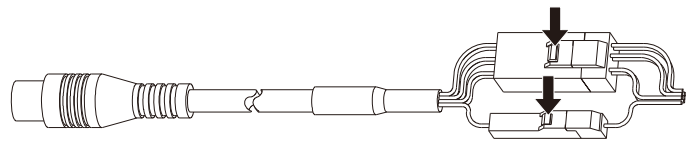

Pull out the connector while pressing the arrow.

- RIC-10A (Probe set) set contents (optional)
 - RIC-07A (Logic input cable)
 - RIC-08A (Alligator clip cable)
 - RIC-09A (IC clip cable)
 - Logic Seal

⚠ CAUTION

To avoid break-downs or short-circuiting accidents, please make sure to abide by the items written below.

- Maximum input voltage
 - In case the input voltage exceeds the specifications, the circuit at the input part will break down so even if the input voltage exceeds the specifications only for an instant, please don't input.
 - Please take care that no static electricity is applied on the logic/pulse signal input terminal.

<Input terminal Each channel / Common terminal interval>

Maximum input voltage : 26.4Vmax

CHECKPOINT

The input of Logic/Pulse module has been pulled up 10K Ω , however, the module may be affected by the external noise when the input is opened.

In such cases, please take the following measures.

- Set the voltage input without having to open the input.
- Set the filter to ON (approx. 50 Hz) in the input settings.

(5) High-voltage Module (GL7-HV: Optional)

This explains how to connect the input cable.

⚠ WARNING

During wiring, confirm that the signal's supply source is turned OFF to prevent electrical shocks.
Also, position the GL7000 input cable away from any power lines and ground cables.

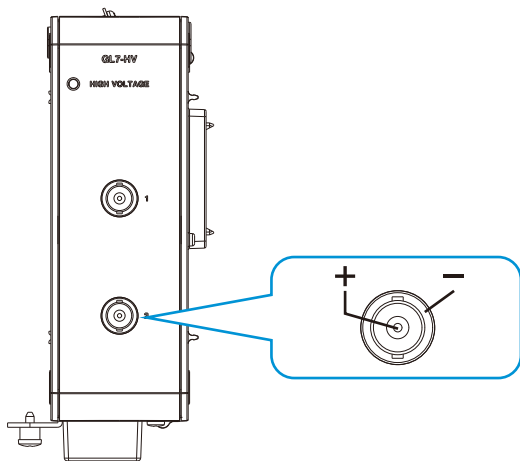

+High-voltage terminal (Terminal for inputting the high-voltage side of the input signal)

-Low voltage terminal (Terminal for inputting the low-voltage side of the input signal)

Voltage input

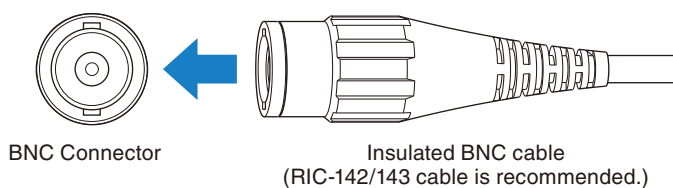

⚠ CAUTION

To avoid break-downs or short-circuiting accidents, please make sure to abide by the items written below.

● Maximum input voltage

- In case the input voltage exceeds the specifications, the circuit at the input part will break down so even if the input voltage exceeds the specifications only for an instant, please don't input.
- Please take care that no static electricity is applied on the analog signal input terminal.

<Input terminal +/- terminal interval (A etc. on the figure right)>

Maximum input voltage : 1000 Vp-p

<Input terminal (-)/Input terminal (-) interval (B etc. on the figure right)>

Maximum input voltage : 300 VACrms

Withstand voltage : 2300 VACrms/1 minute

<Input terminal (-)/GND terminal interval C etc. on the figure right)>

Maximum input voltage : 300 VACrms

Withstand voltage : 2300 VACrms/1 minute

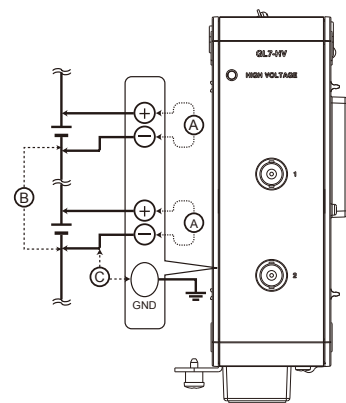

(6) DC Strain Module (GL7-DCB: Optional)

This explains how to connect the input cable.

⚠ DANGER

To avoid break-downs or short-circuiting accidents, please make sure to abide by the items written below.

- Please do not apply more than 60 Vp-p voltage between the voltage analog input part and main module (GND terminal), and between the each analog input channels.
- Voltage and current are supplied from this module when strain or resistance input is used. Do not apply any external voltage or current to the measured, such as strain gauge or resistance. There's a danger that you'll break it.
- Voltage and current are supplied from this module when strain or resistance input is used. GL7-DCB is 4 analog channels in 1 unit. Do not make measurements with multiple channels (Including different units) for the same measured strain gauge or resistance. There is a risk of serious damage to this module.

⚠ WARNING

During wiring, confirm that the signal's supply source is turned OFF to prevent electrical shocks. Also, position the GL7000 input cable away from any power lines and ground cables.

⚠ CAUTION

The number of DC strain modules that can be installed is up to 8 modules. If more than 8 modules are installed, the message is displayed when the power is turned.

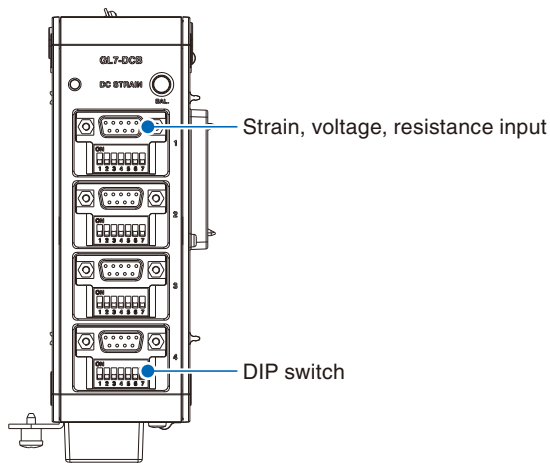

(1) This section provides the descriptions of the terminals and the input terminal arrangement.

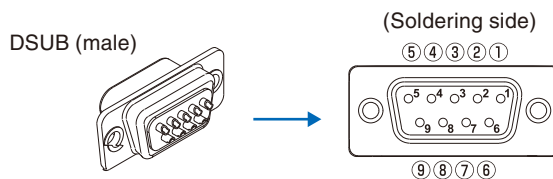

DSUB Connector No.	Notation	Descriptions	DSUB-NDIS Conversion cable	Conversion cable between DSUB and screw terminal
①	B-	Excitation voltage (-)	C	1
②	IN-	Input signal (-)	B	2
③	S+	Sense (+)	-	3
④	T-	TEDS (-)	G	4
⑤	R+	Shunt resistance	-	5
⑥	S-	Sense (-)	-	6
⑦	IN+	Input signal (+)	D	7
⑧	B+	Excitation voltage (+)	A	8
⑨	T+	TEDS(+)	F	9
Connector chassis	Shield	Shield	E	FG

(2) This section explains how to connect the signal input cable with the supplied connector (DSUB).

Strain input

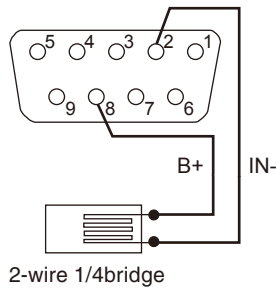

Voltage input

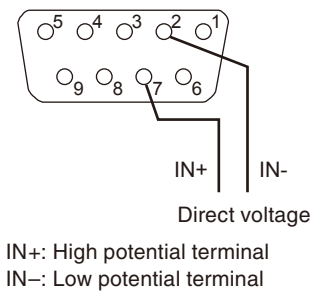

Resistance input

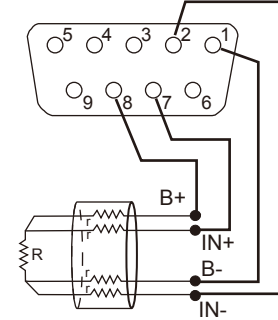

When measuring the resistance, as shown in Figure above, wire using the following 4-wire, or short between (1) and (2), and (7) and (8).

⚠ DANGER

- Voltage and current are supplied from this module when strain or resistance input is used. Do not apply any external voltage or current to the measured, such as strain gauge or resistance. There's a danger that you'll break it.
- Voltage and current are supplied from this module when strain or resistance input is used. GL7-DCB is 4 analog channels in 1 unit. Do not make measurements with multiple channels (Including different units) for the same measured strain gauge or resistance. There is a risk of serious damage to this module.

How to assemble the DSUB connector (Standard accessory)

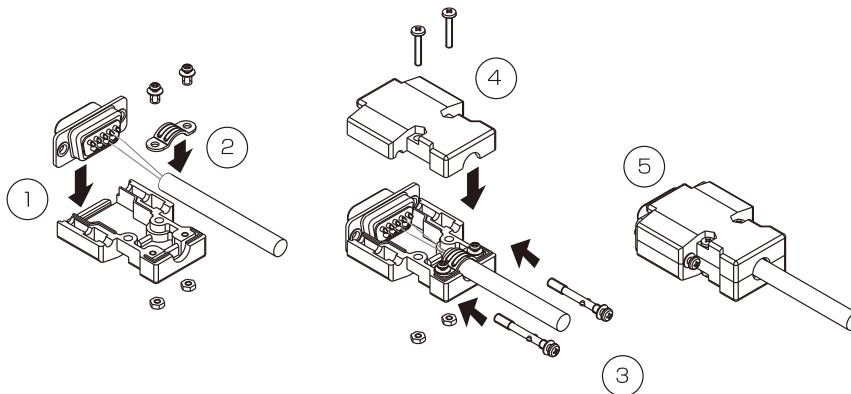

- ① Mount the DSUB connector in the connector cover.
- ② Fix the cable with the cable clamp and 2 screws.
- ③ Set the two DSUB fixing screws to the case.
- ④ Secure with the two screws after putting the connector cover.
- ⑤ Connect the assembled DSUB connector to this module.

⚠ WARNING

To prevent damage to the DSUB connector, do not over-tighten the screws when connecting the connector. (Recommended tightening torque: 4 kgf•m or less)

(3) This section explains how to connect the conversion cable and the strain sensor.

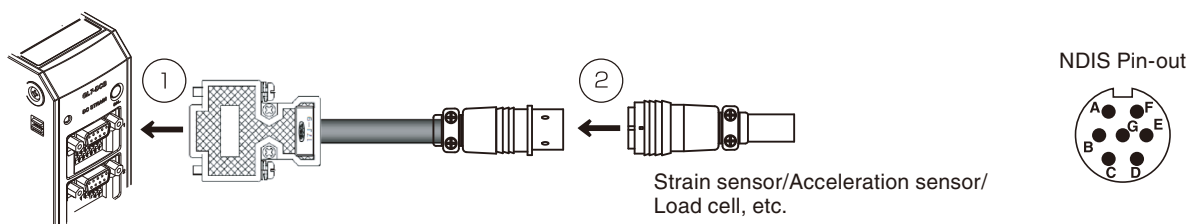

- ① Connect the conversion cable to the DC strain module.
- ② Connect the strain sensor to the conversion cable.

* Please use the NDIS connector manufactured by Tajimi, which conforms to PRC03-12A10-7M10.5.

(4) Wiring and connecting the DSUB-Screw terminals conversion connector.

The following examples show the connection of the DSUB-Screw terminals conversion connector with quarter bridge 2 wires.

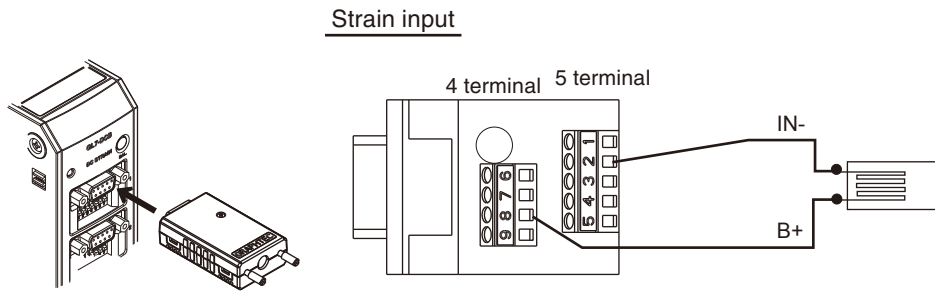

How to assemble the DSUB-Screw terminals conversion connector (Optional B-561)

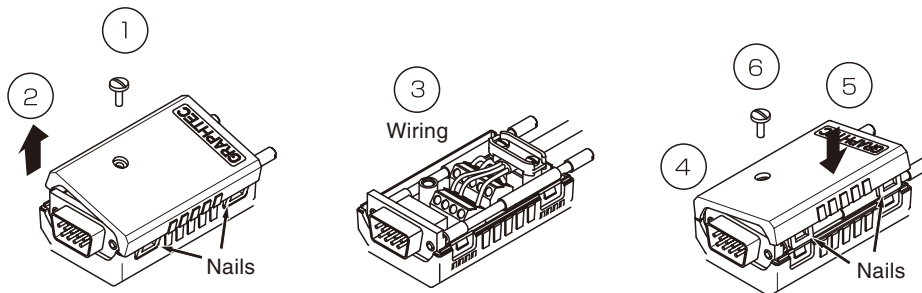

- ① Remove the screw to open the connector cover.
- ② Lift it away from the side of the cover without the nails
- ③ Wire between the internal terminals.
- ④ Fit the connector cover to the side of the cover without the nails.
- ⑤ Push the cover until the side with the nails is locked
- ⑥ Mount the screw removed in step ①. It is completed.

(5) Connecting the TEDS (Transducer Electronic Data Sheet) sensor No. 4 to 9 DSUB terminals are used to connect the TEDS only.

Use to connect the sensor (Standard: IEEE1451.4 Class 2) with TEDS function.

⚠ CAUTION

If the TEDS function is not equipped or the standard is not compatible, the function is not available when connected.

⚠ CAUTION

To avoid break-downs or short-circuiting accidents, please make sure to abide by the items written below.

- Maximum input voltage
 - In case the input voltage exceeds the specifications, the circuit at the input part will break down. Please don't input it.
 - Please take care that no static electricity is applied on the analog signal input terminal.

<Input terminal (+)/ Input terminal (-) interval (A etc. on the figure below)>

Maximum input voltage : DC10Vp-p

<Input terminal (-)/Input terminal (-) interval (B etc. on the figure below)>

Maximum input voltage: 10Vp-p

<Input terminal (-)/GND terminal interval (C etc. on the figure below)>

Maximum input voltage: 60Vp-p

Withstand voltage: 1000Vp-p/1minute

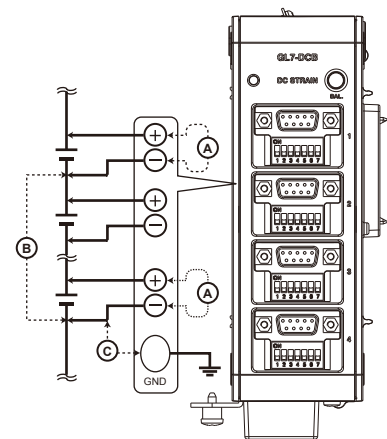

(6) Setting the DIP switch.

Depending on the input method, set the switch (See Table below).

The settings of DIP switch are shown in the Table below. For the numbers in the Table, 0 (zero) is OFF and 1 is ON.

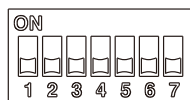

Input method		Strain gauge 120Ω							Strain gauge 350Ω						
		1	2	3	4	5	6	7	1	2	3	4	5	6	7
Strain input	2-wire 1/4bridge	1	1	1	1	1	1	1	1	1	1	1	1	0	0
	3-wire 1/4bridge	1	1	0	0	1	1	1	1	1	0	0	1	0	0
	4-wire 1/4bridge	1	1	0	0	1	1	1	1	1	0	0	1	0	0
	3-wire 1/2bridge	0	1	0	1	1	1	1	0	1	0	1	1	0	0
	4-wire 1/2bridge	0	1	0	1	0	1	1	0	1	0	1	0	0	0
	5-wire 1/2bridge	0	1	1	1	0	1	1	0	1	1	1	0	0	0
	4-wire full bridge	0	0	0	1	1	1	1	Set the DIP switch as shown in the left table * Voltage and resistance inputs do not affect the strain gauge.						
6-wire full bridge	0	0	1	1	0	1	1								
Strain sensor input	4-wire	0	0	0	1	1	1	1							
	6-wire	0	0	1	1	0	1	1							
Voltage input/Resistance input		0	0	0	1	1	1	1							

CHECKPOINT

The settings of DIP switch are displayed on the menu in the main module. The DIP switch should be set depending on the input method.

● When the strain gauge is used

When the strain is input, set the DIP switch to "bridge circuit".

Always set depending on the strain gauge resistor.

* See the descriptions of the strain gauge and bridge circuit configuration to set the DIP switch.

● When the strain sensor is used

When the strain sensor is used, the settings are different in 4 wires and 6 wires.

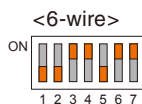
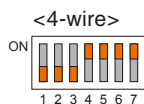

● When the Voltage/Resistance input is used

In this case, set the DIP switch as shown in the figure below regardless of the strain input.

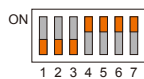

Descriptions of the strain gauge and bridge circuit configuration

The internal bridge circuit of the strain gauge wiring is configured with DIP switch, as shown in the figures below.

⚠ WARNING

When the bridge voltage is used in more than 5 V, the more than 350Ω gauge resistance should be used.
If using 120Ω gauge resistor, the module may be damaged.

		Wiring strain gauge	Bridge circuit	Bridge resistor	
				120Ω	350Ω
1/4 bridge	2-wire				
	3-wire				
	4-wire				
1/2 bridge	3-wire				
	4-wire				
	5-wire				
Full bridge	4-wire				
	6-wire				

(7) Charge Module (GL7-CHA): Optional

This explains how to connect the input cable.

⚠ WARNING

During wiring, confirm that the signal's supply source is turned OFF to prevent electrical shocks.
Also, position the GL7000 input cable away from any power lines and ground cables.

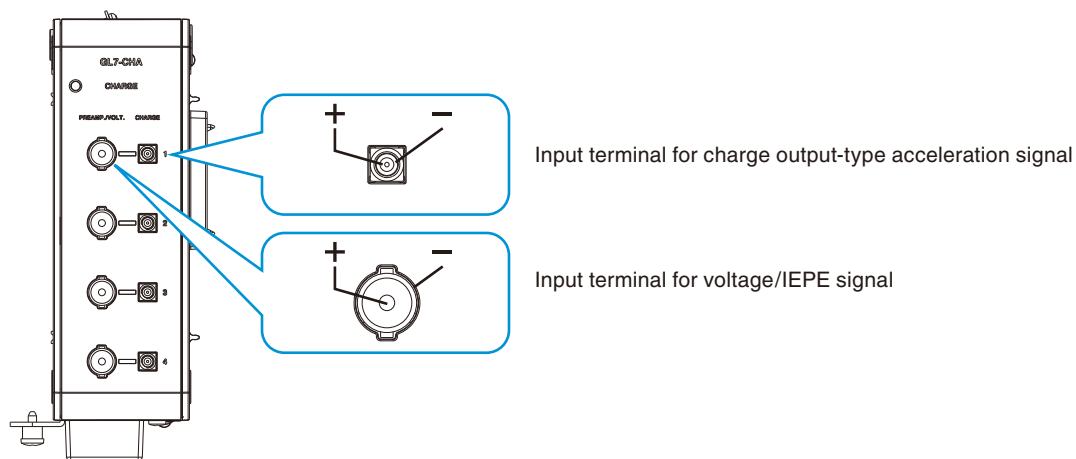

Input terminal for charge output-type acceleration signal

Input terminal for voltage/IEPE signal

+ High-voltage terminal (Terminal for inputting the high-voltage side of the input signal)

- Low voltage terminal (Terminal for inputting the low-voltage side of the input signal)

⚠ WARNING

Do not connect the two connectors to the same channel.
Since this may cause a malfunction, only one connector should be connected to the channel.

Voltage/IEPE signal connection

When connecting the voltage/IEPE, connect to the BNC connector.

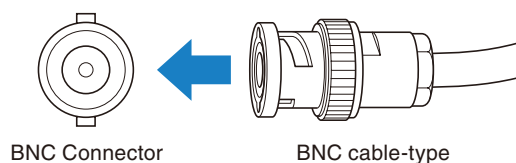

BNC Connector

BNC cable-type

The available acceleration sensor specification is 0.01 mV/(m/s) to 999.9 mV/(m/s).

⚠ WARNING

When the voltage signal is set, change the input setting to DC, AC, DC-RMS, AC-RMS.
If Built-in amplifier is set, the power voltage for driving the sensor from the BNC connector is applied. This power voltage may damage the modules and the object to be measured.

Charge-type acceleration signal connection

For the charge-type acceleration sensor connection, connect to the miniature connector.

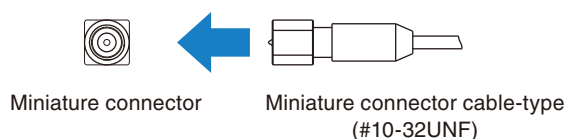

Miniature connector

Miniature connector cable-type
(#10-32UNF)

The available acceleration sensor specification is 0.01 pC/(m/s) to 999.9 pC/(m/s).

⚠ CAUTION

To avoid break-downs or short-circuiting accidents, please make sure to abide by the items written below.

● Max. input voltage and charge

- When the voltage or charge exceeding the specification is input, the input circuit is broken. Do not input the voltage exceeding the specifications even for a moment.
- Please take care that no static electricity is applied on the analog signal input terminal.

<Input terminal (+)/Input terminal (-) interval(A etc. on the figure below)>

Maximum input voltage : 25Vp-p

Max. input charge : 50000pC

<Input terminal (-)/Input terminal (-) interval(B etc. on the figure below)>

Maximum input voltage : 25Vp-p

Withstand voltage : 300Vp-p/1minute

<Input terminal (-)/GND terminal interval(C etc. on the figure below)>

Maximum input voltage : 25Vp-p

Withstand voltage : 300Vp-p/1minute

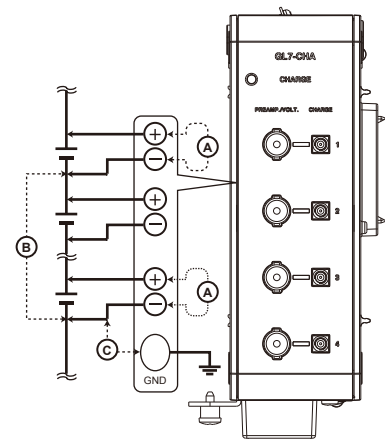

(8) Voltage Output Module (GL7-DCO): Optional

This explains how to connect to the voltage output terminal.

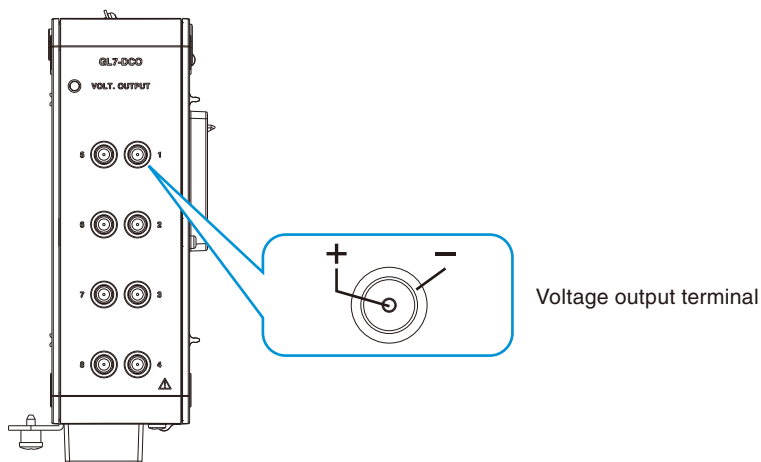

+ High-voltage terminal (Terminal for outputting the high-voltage side of the output signal)

- Low voltage terminal (Terminal for outputting the low-voltage side of the output signal)

⚠ CAUTION

- The external signal should not be input to the voltage output terminal.
- During wiring, confirm that the power of the module is turned OFF.
- The voltage output terminal on this module is not isolated. (GND terminal and common potential)
Also, - terminal (low-voltage) of each ch is connected to all ch.

Connection of Output Signal

When connecting between the voltage output terminal and equipment to be received, the SMA-BNC conversion cable (B-562) sold separately should be used.

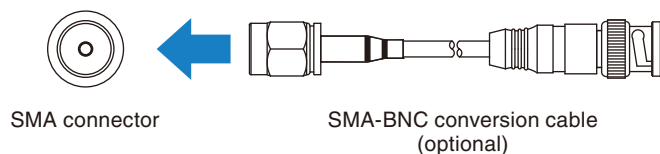

If you do not use the cable sold separately, always connect with the cable that conforms to SMA connector specifications.

⚠ WARNING

Do not apply the external voltage to the voltage output terminal. This module may be damaged.

⚠ CAUTION

- During installation, a 4 kgf.cm screw tightening torque is recommended.
- Do not short-circuit between the + side (high-voltage) and - side (low-voltage) of the voltage output terminal. This module may be damaged.
- When the power is turned on and off, the voltage may be output from the output terminal for 10 ms. If the GL7000 is affected by the output voltage, please disconnect the output cable before the power is turned on or off.
- The load current of the voltage output is $\pm 10\text{mA}/\text{ch}$ (The total output current of the modules to be used must be $\pm 40\text{mA}$ or less.).

2.11 Input/output Cable Connection for GL

Trigger and exterior sampling input and trigger output functions can be used by using an output cable for the GL input/output cable (B-513: optional). The alarms are output from the alarm signal output terminal on the Alarm module.

The output cable for the GL input/output cable (B-513: optional) is connected to the REMOTE terminal as shown on the chart below.

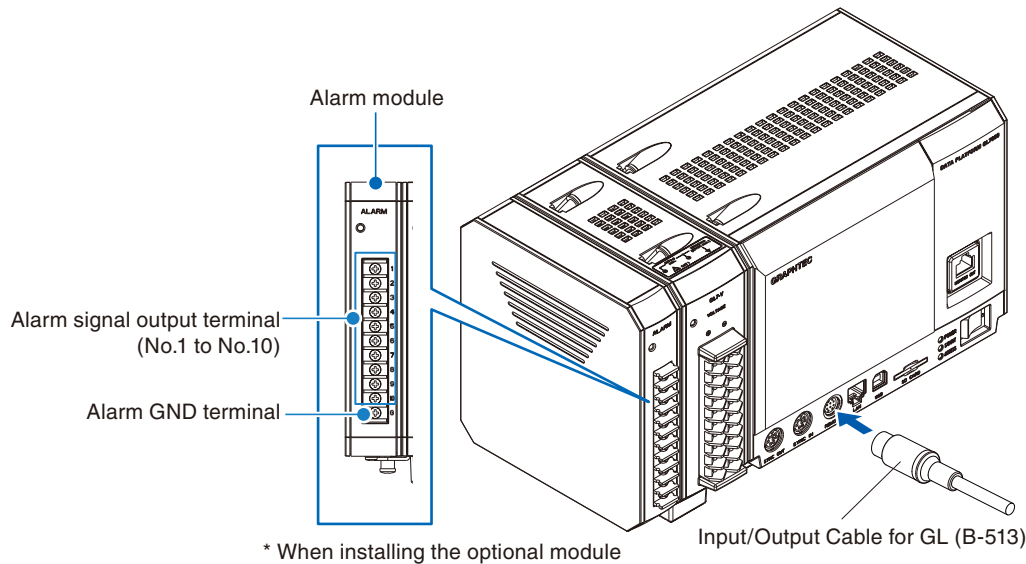

REMOTE terminal input specifications

Items	Description
Maximum input voltage	0 to +24 V (single-ended ground input)
Input signal	Non-voltage contact (a contact, b contact, NO, NC), Open collector, Voltage input
Input threshold voltage	Approx. +2.5 V
Hysteresis	Approx. 0.5 V (Approx.+2.5V to Approx.+3V)

Output specifications

Items	Description
Alarm Signal Output Specifications	Open collector output (pull-up resistance 10K Ω) < Maximum rating of the output transistor > <ul style="list-style-type: none"> • Voltage between collector and GND: 50 V • Collector current: 2.0 A • Collector dissipation: 0.6W
REMOTE Signal Output Specifications (TRIGGER Output, etc.)	Open collector output (pull-up resistance 10 K Ω) < Maximum rating of the output transistor > <ul style="list-style-type: none"> • Voltage between collector and GND: 30 V • Collector current: 0.5 A • Collector dissipation: 0.2 W

* The above are available in the output circuit. These are the highest-rated transistors. When you use them, please leave more than sufficient margin for fluctuations.

Internal equivalent circuit in input/output circuit

REMOTE signal input circuit

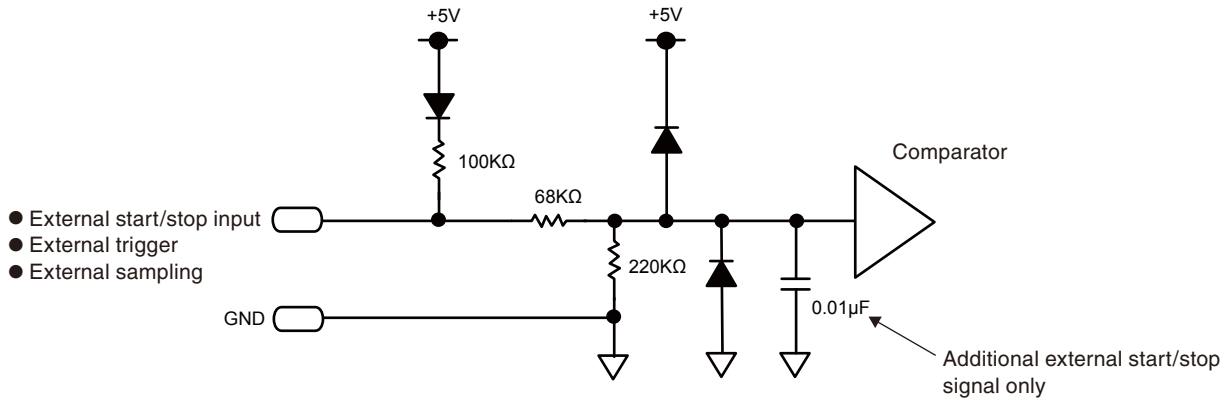

REMOTE signal input circuit

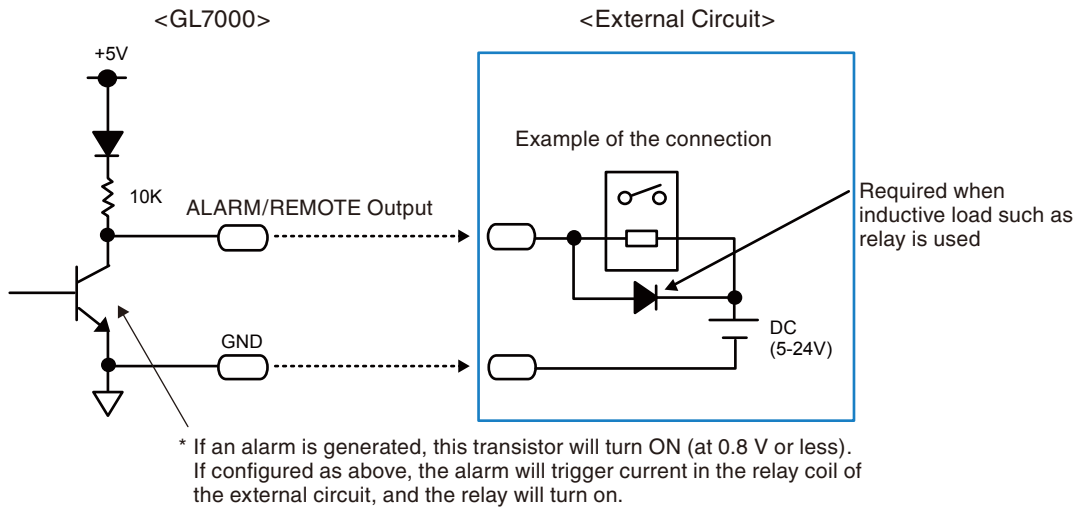

GL input and output cabling

Cable tips are bare tips. Perform wiring for the necessary functions.

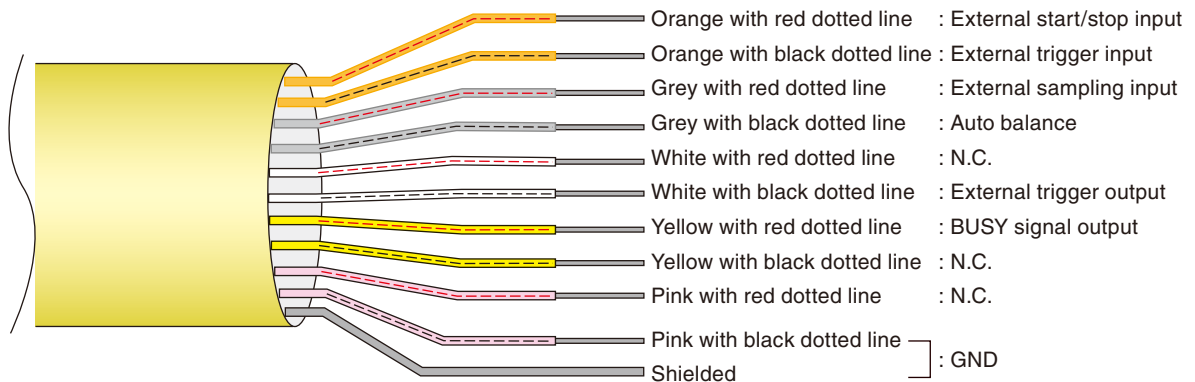

CHECKPOINT

For the cables currently not used and not connected, do not connect anything.

REMOTE Functions

Signal name	Function	Description
External start/stop input	Controls the start/stop of the measurement. <ul style="list-style-type: none"> L (0 V, GND short): starts the measurement. H (5 V, Open) : stops the measurement. 	Detection cycle: 10 ms intervals
External trigger input	External trigger signal <ul style="list-style-type: none"> The trigger occurs immediately when L (0 V, GND short) is input. When you want to use this function, it is necessary to set the trigger. For details, see "Trigger/Alarm Settings" in page 3-64	Minimum pulse width: 500 μ s
External sampling input	External sampling signal <ul style="list-style-type: none"> When L (0 V, GND short) is input, a point recording is performed. When you want to use this function, it is necessary to set the sampling. For details, see "External Sample" in page 3-50.	Minimum pulse width: 500 ns
Auto-balancing input	Perform the auto-balancing remotely. <ul style="list-style-type: none"> When the L (0 V, GND short circuit) is input, the auto-balancing is performed. 	Only use the DC strain module.
External trigger output	When a trigger is detected, the pulse with L level (0.8 V or less) is output. <Output Pulse Specifications> <ul style="list-style-type: none"> Pulse level: L (0.8 V or less) Pulse width: 500 μs * Both start and stop triggers output a trigger pulse. An interval between the start and stop triggers should be 1 ms or more.	
External Busy Output	When the auto-balancing is performed, the BUSY signal is output. <ul style="list-style-type: none"> When the auto-balancing is performed, the L (0 V) signal is output. 	Only use the DC strain module.
GND	This is a GND for the input and output signals.	

2.12 Noise Countermeasures

In case the measured values fluctuate due to exogenous noise, the following measures are recommended. (Depending on the type of noise, the result may change.)

- **Make absolutely sure to ground the chassis GND of the equipment to be measured or received (When connecting the GL7-DCO module).**

Absolutely making sure to ground the chassis GND of the measuring object to a favorable ground may have an effect.

- **Connecting the chassis GNDs of this module and the equipment to be measured or received (When connecting the GL7-DCO module).**

Connecting the chassis GND of the measuring object and the GND terminal of the main module with an electrical cable as short and thick as possible, and further gaining potential equalization by grounding it may have an effect.

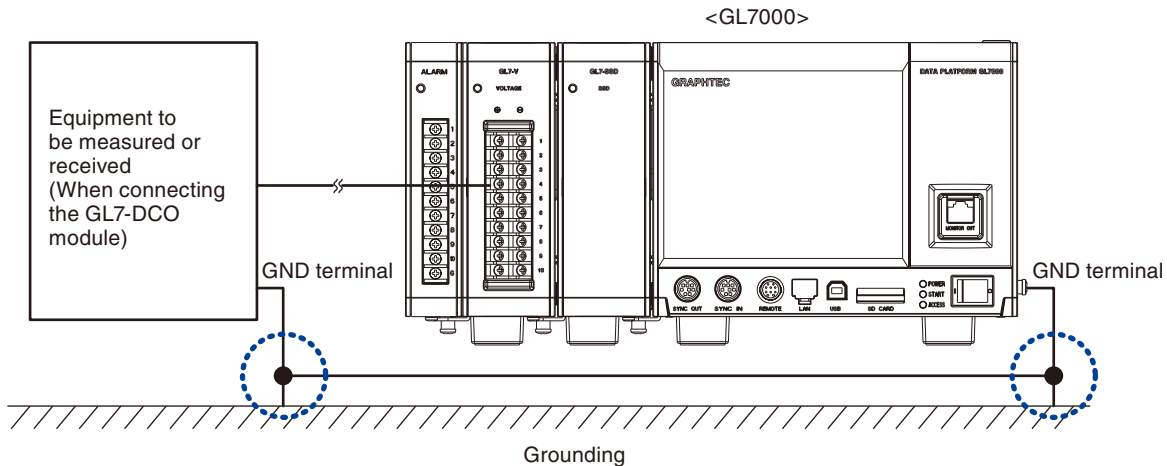

<When Voltage module/High Speed Voltage module/High Voltage module/DC Strain Module /Charge Module is used>

- **Using the filter function of the instrument**

Setting the filter to anything but OFF on the main body's input settings menu.

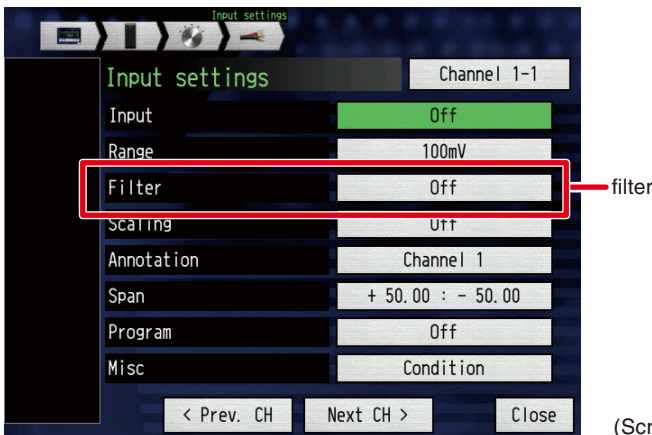

(Screen for when the optional display module is connected)

<When Voltage/Temperature module is used>

- **Using the filter function of the instrument**

Setting the filter to anything but OFF on the main body's input settings menu.

- **Use the sample interval where this module's digital filter becomes effective**

On the Recording settings menu of the main module, set the sample interval to 500 ms or above. Set your commercial power-supply frequency from "Other Settings" in this module.

<When using the Voltage Output Module (GL7-DCO)>

When a filter function is contained in the equipment to be received, the function should be enabled.

CHAPTER 3 Measure and Set

This chapter explains how to measure and set various parameters when an optional Display Module is installed.

PRODUCT SUMMARY

- 3.1 Nomenclature
- 3.2 Touch-panel Functions
- 3.3 Explanation of the Common Process Screens
- 3.4 Key Operations
- 3.5 Description of Each Operating Mode
- 3.6 Explanation of the Settings Menu
- 3.7 Web server functions

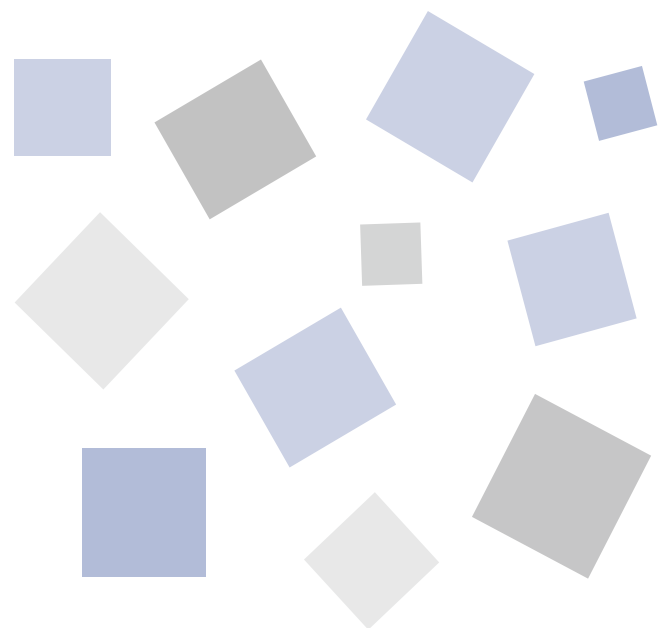

3.1 Nomenclature

(1) Waveform + Digital Screen

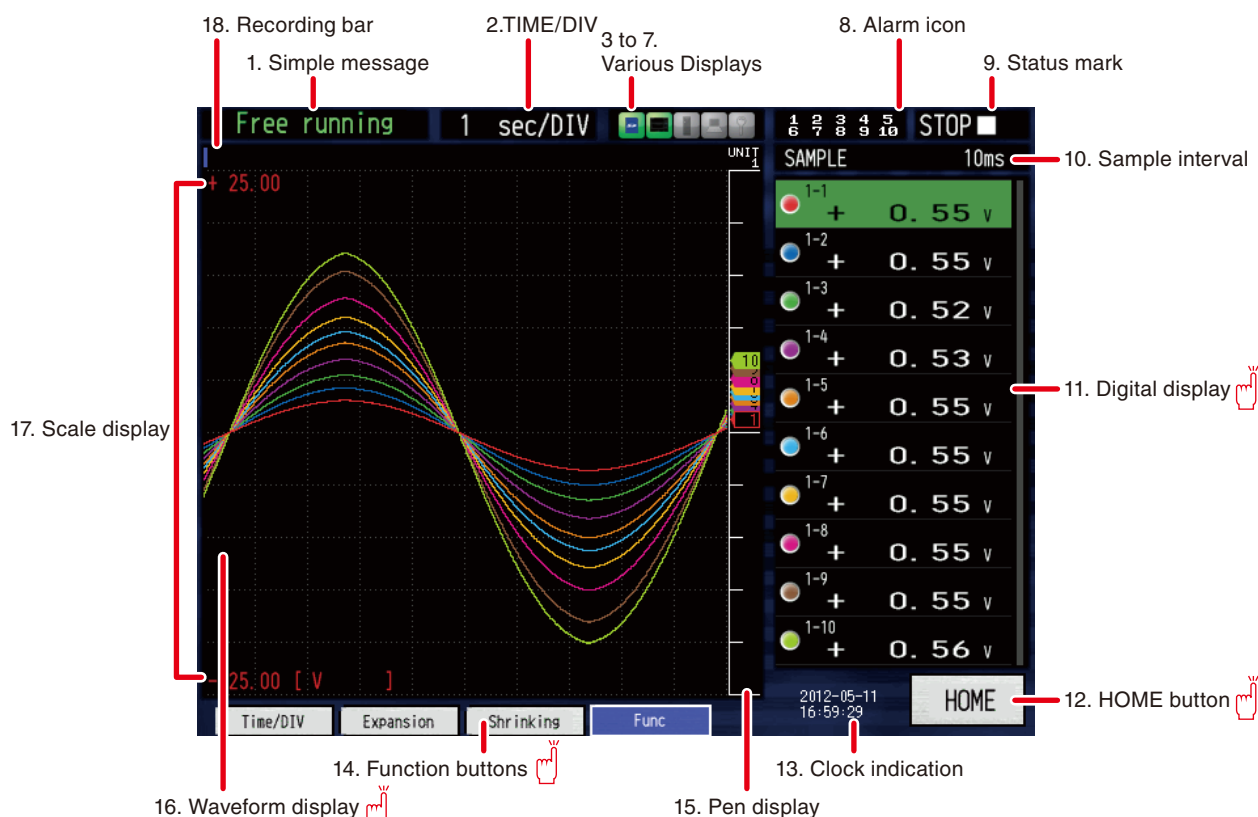

☞: "11. Digital display", "12. Home button", "14. Function button, and "16. Waveform display" are enabled by touching a finger.

1. Simple message

Displays the active status of the GL7000.

Free running	: Displayed when recording is not performed immediately after turning on the power.
Armed	: Displayed when waiting for a trigger to complete once measuring has begun.
Waiting for current timer	: Displayed when waiting for a timer of Current (low-speed) capturing of dual sampling function.
RAM recording	: Shown when Built-in RAM of each module is in use
Memory recording	: Displayed when data is being recorded the GL7000 internal memory.
SD Card recording	: Displayed when data is being recorded to the SD card.
SSD recording	: Displayed when data is being recorded to the SSD.
Current capturing	: Displayed when performing Current (low-speed) capturing of dual sampling function.
Current / Event capturing	: Displayed when performing Current (low-speed) capturing and Event (high-speed) capturing of dual sampling function.
Writing Disk	: Displayed when recorded data is being writing to the internal memory, SD card, or SSD following recording.
Finished	: Displayed only when a message is displayed if the recording is stopped in the full disk.
Replaying RAM	: Displayed when data within built-in RAM of a module is being replayed.

- Memory review : Displayed when the data recorded in GL7000 internal flash memory is being replayed.
- Replaying SD Card : Displayed when the data recorded in SD card is being replayed.
- Replaying SSD : Displayed when data recorded on an SSD is being replayed.
- Current (Memory, SD) replaying : Displayed when replaying Current (low-speed) data of dual sampling function.
- Event (RAM, SSD) replaying : Displayed when replaying Event (high-speed) data of dual sampling function.
- Backup Failed : Displayed when backup fails (e.g. the backup destination (SD card) has been removed, etc.).
- Demo wave mode : Displayed when displaying a demo waveform as opposed to measured data.
- * For more information about data recording functions such as trigger and repeat, see the section titled "(5) Trigger/Alarm settings" on page 3-83.
- * For more information about recording memories, see the section titled "(1)-4 Destination" on page 3-63.

CAUTION

- When the message displays "Built-in RAM recording in progress", "Internal memory recording in progress", "SD card recording in progress", "SSD recording in progress", "Writing in progress", please do not turn off the power. This can lead to data being damaged and/or not recorded.
 - Data recorded to the built-in RAM will be erased when the power is turned off. Please save important data on something such as an SD card.
 - Before operating, please make sure that the status marker displays "STOP".
-

2. Time/DIV

Currently time scale is displayed.

3. SD card access displays



: SD card is not present.



: SD card is present, but not being accessed.



: SD card is being properly accessed. Do not remove SD card.

CAUTION

Please do not remove it or turn off the power to the GL7000 when the SD card is being accessed. This can lead to data being damaged and/or becoming inaccessible.

4. Built-in flash memory access displays



: Built-in flash memory is not being accessed.





: Built-in flash memory is being accessed properly.

CAUTION

Please do not turn off the power when accessing the built-in flash memory of the GL7000. This can lead to data being damaged and/or becoming inaccessible.



5. SSD access displays

-  : SSD module is not mounted.
-  : SSD module is mounted, but not being accessed.
-  : SSD module is mounted properly.

CAUTION



Please don't turn off the power to the GL7000 when the SSD Module is being accessed. This can lead to data being damaged and/or becoming inaccessible.

6. Remote displays

-  : Local. Operations that can be carried out from the GL7000.
-  : Remote. With the exception of some functions, operations can be carried out from the PC. When closing the connection to the GL7000 application (GL-Connection), it is automatically returned to local mode. If it does not automatically enter local mode, please press the "QUIT" key.

Remote lock release function has been newly installed from PC software GL-Connection V 2.20 or later. Using this function, you can change the settings and perform the capture control from the GL7000 even while controlling with GL-Connection. For details of this function, refer to the GL-Connection User's Manual.

7. Key-lock displays





-  : Key-lock is not in use. Normal operations may be carried out.
-  : Key-lock is in use. All keys are locked. By pressing the LOCK key (refer to the section titled "(5) LOCK" on page 3-46), the key-lock can be set or cleared. A password can also be set in order to clear the key-lock. For details, see the section labeled "Set and clear the key-lock with the password" on page 3-47.

8. Alarm displays

Displays the alarm output status.

The number where an alarm occurred is displayed in red. Further, the channel with the alarm turns red on the input value on the digital display.

9. Status mark

-  : Displayed when data is being neither recorded nor replayed.
-  : Displayed when data is being recorded.
-  : Displayed when data is being replayed.
-  : Displayed when replaying on the double-screen display.

CAUTION

- Please do not turn off the power or remove the SD card when the status mark is displaying anything other than "STOP". This can lead to data being damaged and/or becoming inaccessible.
- Data recorded to the built-in RAM will be erased when the power is turned off. Please save important data on something such as an SD card.
- Please operate after making sure that "STOP" is being displayed.

10. Sample interval

Current sample interval setting is displayed.

When dual sampling function is enabled, Current (low-speed) sampling and Event (high-speed) sampling are written together.

E: Event, C: Current

SAMPLE E 500us/C 10ms

11. Digital displays

Input value of each channel is displayed. Annotation and waveform color also are displayed.

Waveforms can be controlled by touching the waveform display section. By touching the waveform display part, wave processing is performed. For details, see "16. Waveform display" on page 3-6.

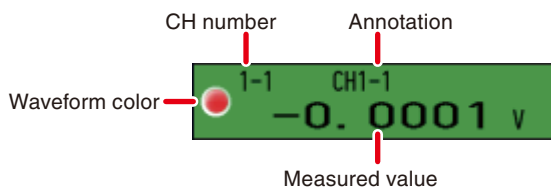

Waveform color : The waveform color currently set. (For details, see "(11) Input settings" on page 3-98.)

CH number : The number displayed corresponds to the module number – channel number.

Annotation : Displays the inputted annotation. (For details, see "(11) Input settings" on page 3-98.)

Measured value : Displays the measured value.

12. HOME button

Pressing this button displays HOME menu. For details, see "(2) HOME screen on page 3-9.

13. Clock

Pressing this button displays HOME menu. For details, see "(2) HOME screen on page 3-9. Displays current date and time. For more information about how to set date and time, see "(9) Date/Time settings" on page 3-92.

14. Function buttons

This is a convenient function for easy access to various operations.

By pressing the "Func" button, the function menu listing multiple function buttons can be displayed.

The button line that was selected last time is displayed in the foreground, so you do not have to open the list screen many times.

* When you touch the screen, the function button is enlarged for a certain time and it becomes easy to push.

* Displayed item depends on the operation mode.

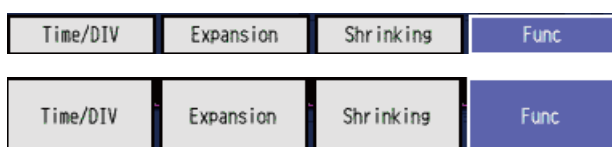

Function menu

The contents of the function menu depend on the operation mode.

The line currently displayed as the function button is highlighted in green.

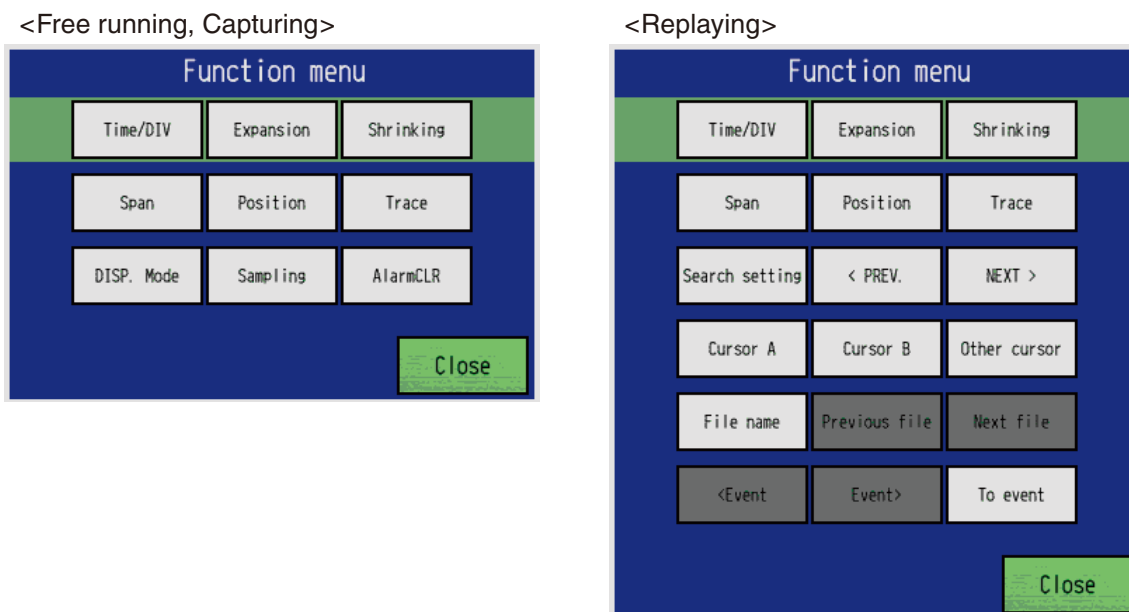

For the operation of each button, refer to the description of each operation mode.

15. Pen display

The signal position, trigger position, and range of alarm for each channel are displayed.

16. Waveform display

Displays waveform of input signal.

Control of the following can be done by touching the waveform display.

- Changing position of the selected channel
: Slide up or down while touching a single point.
- Changing the span of the selected channel
: Spreading apart two points up and down will increase span. Pulling the two points together will decrease the span.
- Changing the timescale
: Spreading apart two points left and right will make the timescale faster. Pulling the two points together will make the timescale slower.

* By touching the digital display part, the channel can be selected.

17. Scale display

Displays the upper/lower limit scale of the currently displayed channel(s).

18. Recording bar

(1) During data recording

Displays time elapsed and current memory usage.

●Normal capturing

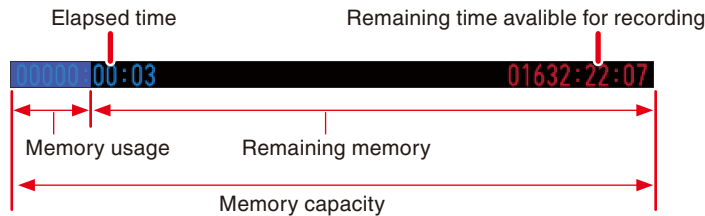

●Dual sampling

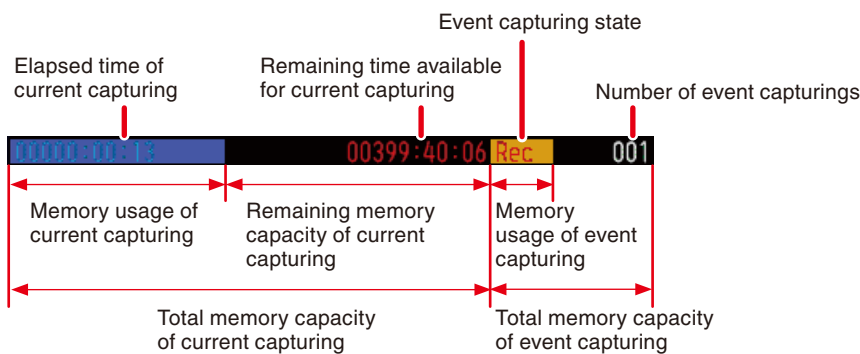

For example, for a 2GB SD card, where approx. 768MB is being used, the memory capacity is 2GB, used memory is approx. 768MB, and the remaining memory is approx. 1.25GB. As recording time elapses, the memory used increases and the remaining memory decreases.

Remaining time available for recording displays the amount of time recordable in accordance to the remaining free memory. However, if the remaining memory exceeds 4GB, remaining recordable time displays 1 file of 4GB.

Event capturing state

Arm : Waiting for trigger of Event (high-speed) side

Rec : Capturing of Event (high-speed) side

Ful : Full state of capturing of Event (high-speed) side

CHECKPOINT

- If available recording time exceeds 99999 hours, "++++:++:++" is displayed. If the time passed exceeds 99999 hours, "++++:++:++" is displayed.
- When recording with CSV format, the capacity varies depending on the measured value. For that reason, the error in the recordable time occurs.

- (2) During data replaying
 Display and cursor positions are illustrated.

●Normal capturing

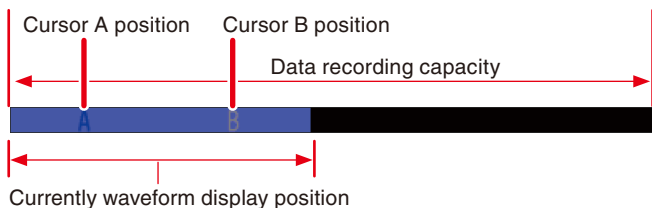

●Dual sampling

Replaying Current (low-speed) data

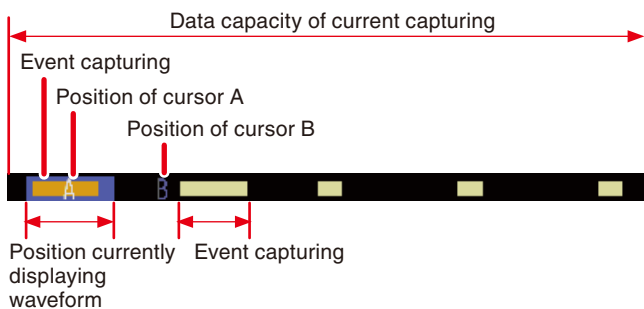

Replaying Event (high-speed) data

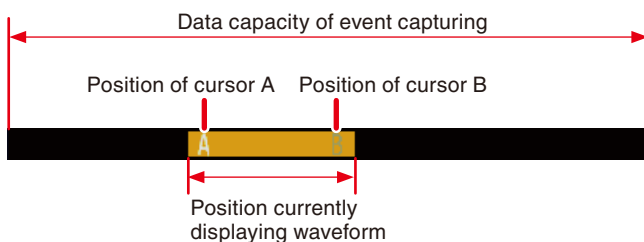

(2) HOME screen

The HOME screen is displayed when the home key is touched.
Icons allowing each operation are displayed

* The displayed content varies depending on connected amplifier and option modules.

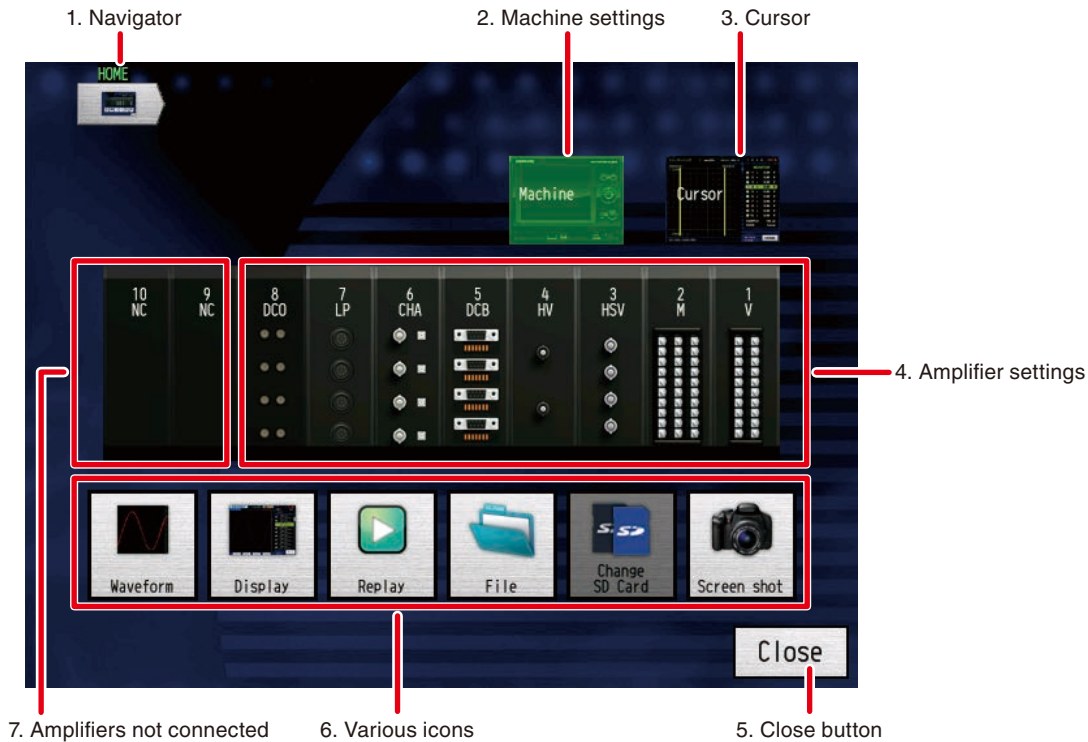

1. Navigator

Hierarchy of the current screen is displayed. Pressing an icon returns to that icon's screen.

2. Machine settings

Change settings that relate to the main module. The following can be set when this icon is pressed.

- Data Settings : Set the sampling rate and other recording settings.
(For details, see "(1) Record settings" on page 3-58, "(2) Marker settings" on page 3-75, and "(3) Backup settings" on page 3-76.)
- Network Settings : Set the IP configuration and other network settings.
(For details, see "(7) IP settings" on page 3-88, and "(8) FTP server settings" on page 3-90.)
- Date/Time Settings : Set the date and time.
(For details, see "(9) Date/Time settings" on page 3-92.)
- Factory Initializing : Resets settings to the factory default.
- Trigger/Alarm Settings: Set trigger and alarm settings.
(For details, see "(5) Trigger/Alarm settings" on page 3-83.)
- I/F USB Settings : Set settings related to the USB interface.
(For details, see "(6) I/F, USB settings" on page 3-87.)
- Other Settings : Set miscellaneous settings such as language and screensavers.
(For details, see "(10) Other settings" on page 3-94.)

3. Cursor

Cursor operation and data retrieval is carried out from this screen. This icon is appears whenever data is replayed.

4. Amplifier settings

Displays currently connected amplifiers. Pressing this icon allows for the input, trigger level and alarm settings to be changed.

5. Close button

Touching this button returns to the previous settings screen.

6. Various icons

Pressing the various icons leads to the setting screens below.

- Waveform Display Settings : Set the waveform and timescale settings among others.
(For details, see "(14) Waveform setting (Simple Waveform Setting)" on page 3-135).
- Display Settings : Set the display mode and calculation settings among others.
(For details, see "(15) Display settings" on page 3-137).
- Replay : Replay the recorded data.
(For details, see "(16) Replay setting screen (Data relapying screen)" on page 3-152).
- File : Allows management of formatting, read conditions and other file related tasks.
(For details, see "(17) File operations" on page 3-152, "(18) Data Save" on page 3-153 and "(19) Save/Load current settings" on page 3-154).
- Change SD Card : Allows SD Card exchange during recording.
Available when recording above a 100ms sampling rate.
(For details, see "(20) Swapping out the SD card" on page 3-156).
- Screenshot : The current waveform displayed is saved with a BMP or PNG format.
The waveform when the Screenshot button is touched is saved.

7. Amplifiers not connected

Displays amplifiers that are not currently connected. This icon may not be changed.

(3) Navigator

The navigator shows the user's current position in the menu tree. One icon at a time is displayed on the screen for each hierarchy level as shown on the chart below. By pressing an icon, you can quickly return to the indicated screen.

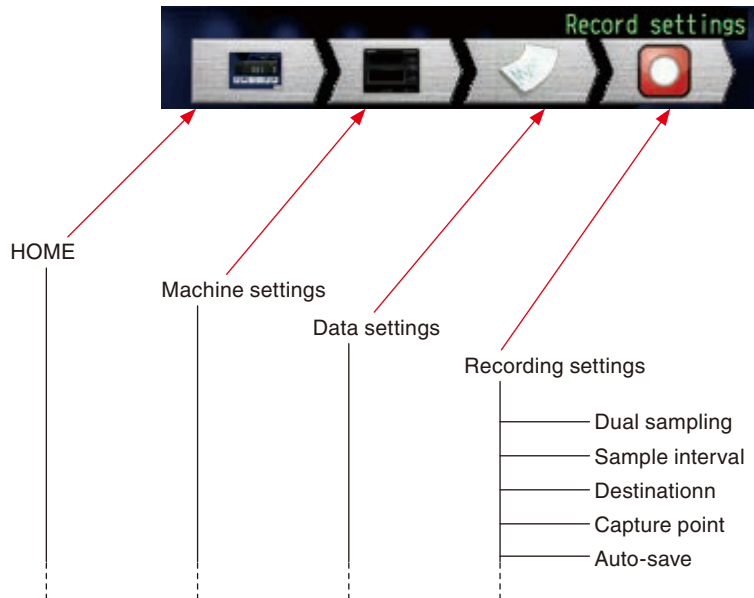

(4) Menu screen

The menu screen displays the middle hierarchy; By pressing the icons, the following menu is displayed, or it is possible to move to the settings screen.

The content of the system settings screen is explained as an example.

When the GL7000 setting icon on the Home screen is touched, the Machine settings screen is displayed.



1. Navigator

Hierarchy of the current screen is displayed. Pressing an icon returns to that icon's screen.

2. Various icons

Pressing the various icons leads to the settings screen and to a menu screen featuring the hierarchy below.

3. Close button

Press this button to return to the previous screen.

4. Title

The title of the currently displayed screen.

(5) Settings screen

The values of the current settings are displayed in the settings screen.

The values set may be changed by touching the setting value.

As an example, the input setting screen is explained.

When "Amplifier settings" → "Channel settings" → "Settings" button on the Home screen are touched in order, Input settings screen is displayed.

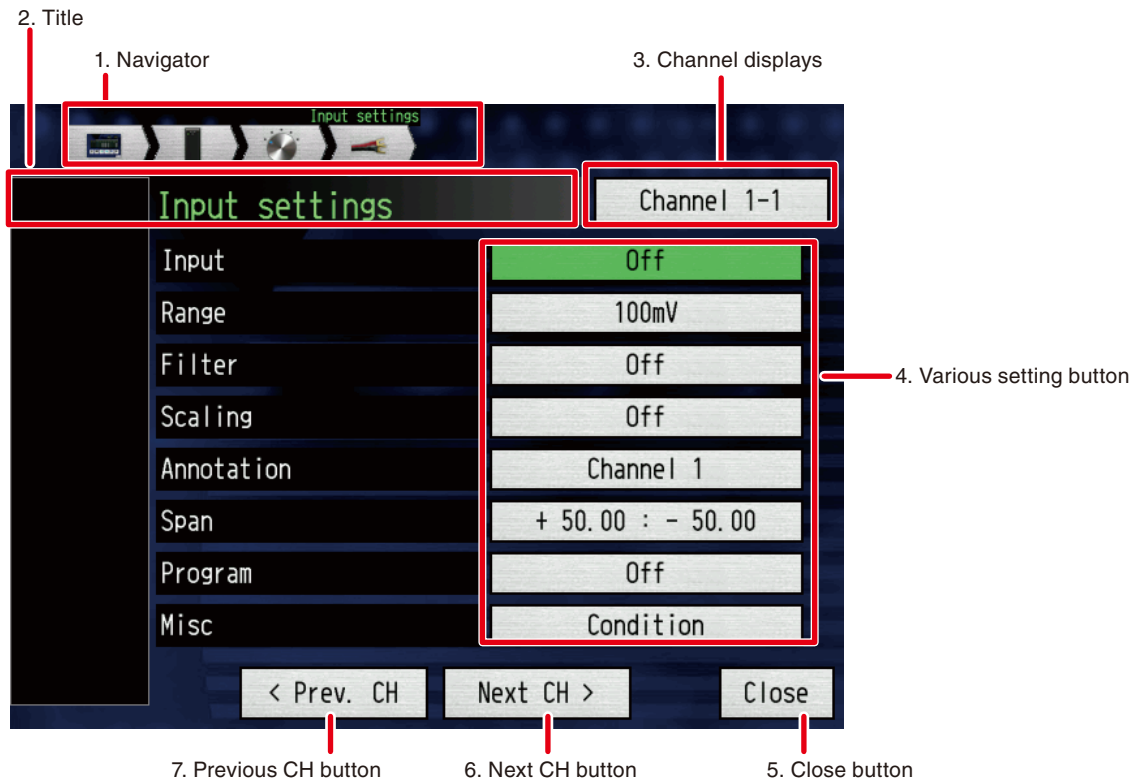

1. Navigator

Hierarchy of the current screen is displayed. Pressing an icon returns to that icon's screen.

2. Title

The title of the currently displayed screen.

CHECKPOINT

The Next CH button and Previous CH button are only displayed on settings screens that are related to the CHs of the amplifiers.

3. Channel displays

The currently set channel is displayed. Touching this button moves the users to the channel selection screen, and from that list it is possible to reselect the channel to set.

These buttons allow users to change the settings of another channel without having to return to the menu hierarchy.

4. Various setting buttons

Buttons for each settings item. Displayed inside the button are the current settings. By pressing this button, the user is moved to the Set Item selection screen and the screen for entering character and numerical value settings.

After pressing this button, it is possible to press another button that lets the user edit more detailed settings.

CHECKPOINT

Among the Set Items there are also items that are only displayed when certain conditions are met.

5. Close button

Press this button to return to the previous screen.

6. Next CH button

Touching this button moves the user to the CH settings screen for the next CH.

This button allows users to change the settings of the next channel without having to return to the menu hierarchy.

7. Previous CH button

Touching this button moves the user to the CH settings screen for the prev. CH.

This button allows users to change the settings of the prev. channel without having to return to the menu hierarchy.

(6) Menu tree

Here the whole menu tree is displayed. On this menu tree you can search for where items you want to set are located.

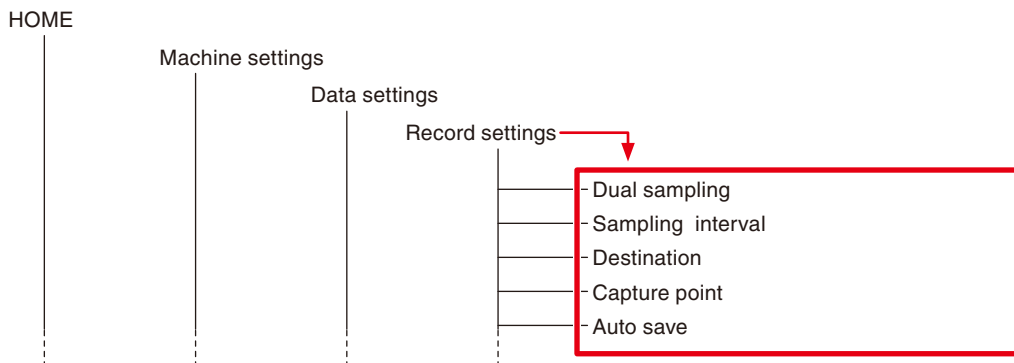

Pressing the "Capture" icon moves the user to a settings screen with set items such as "Sample Interval" (the red framed part on the chart above).







* Output settings: Displayed when the GL7-DCO module is installed.

CHECKPOINT

Among the Set Items there are also items that are only displayed when certain conditions are met.

An explanation of the symbols listed in the menu tree will be given on the next page.

-  **Select** : Touching the setting value that has this icon will display a list to a separate screen where that the setting values can be selected.
-  **Execute** : Pressing the setting for an item that has this symbol will execute its contents.
-  **Numerical Value** : Pressing the setting for an item that has this symbol will open the numerical entry screen.
-  **Character** : Pressing the setting for an item that has this symbol will open the Text entry screen.
-  **File** : Pressing the setting for an item that has this symbol will open the file operations screen.

HOME

Machine settings

Data settings

Capture setting * Normal capturing (Dual sampling Off)

Dual sampling Select

Sample interval Select

Capturing destination Select

Capture point Numerical Value

Auto save

Auto save Select

File name File

Naming method Select

Ring / Relay capture

Ring / Relay capture Select

Data points Numerical Value

Data save

File name File

Naming method Select

File type Select

Capture setting * Dual sampling capturing (Dual sampling On)

Dual sampling Select

Current sample interval Select

Current capturing destination Select

Current captured file name File

Current timer setting

Start timer Select

Time setting Numerical Value

Stop timer Select

Time setting Numerical Value

Repeat capturing Select

Event capturing setting

Auto copy after capturing Select

Event sample interval Select

Event capturing destination File

Capture point Numerical Value

Event trigger / Alarm setting Position

Marker settings

Marker (markers 1 to 8) Character

Marking (each marker) Execute

Backup settings

Backup intervals Select

Backup destination Select

Save folder Character

Output settings (* Displayed when the Voltage Output Module is installed.)

DCO module settings (To Voltage Output Module (GL7-DCO) in each amplifier module (G))

Start / Stop synchronization Select

Repeat output Select

Emergency stop alarm CH output Select

Output level at the time of Stop Select























Data load Execute

Start output Execute

	Symbols	References
Trigger/Alarm settings		P.3-83
Start source	<input type="radio"/> Select	
Level settings	to (A)	
Logic settings	to (B)	
Alarm port number	<input type="radio"/> Select	
Date setting	<input type="radio"/> Select	
Date	1 Numerical Value	
Time	1 Numerical Value	
Weekly settings		
Day (Sunday to Saturday)	<input type="radio"/> Select	
Time	1 Numerical Value	
Time settings		
Time	1 Numerical Value	
Stop source	<input type="radio"/> Select	
Level settings	to (A)	
Logic settings	to (B)	
Alarm port number	<input type="radio"/> Select	
Date setting	<input type="radio"/> Select	
Date	1 Numerical Value	
Time	1 Numerical Value	
Weekly settings		
Day (Sunday to Saturday)	<input type="radio"/> Select	
Time	1 Numerical Value	
Time settings		
Time	1 Numerical Value	
Repeat	<input type="radio"/> Select	
Repeat interval	1 Numerical Value	
Pretrigger points	1 Numerical Value	
Alarm hold	<input type="radio"/> Select	
Burnout alarm	<input type="radio"/> Select	
Network settings		P.3-88
IP settings		
IP address auto acquire	<input type="radio"/> Select	
IP address	1 Numerical Value	
Subnet mask	1 Numerical Value	
Port number	1 Numerical Value	
Gateway	1 Numerical Value	
DNS address	1 Numerical Value	
Keep alive	<input type="radio"/> Select	
ID Name	A Character	
Restart network	<input type="button"/> Execute	
FTP server settings		
FTP server	A Character	
User name	A Character	
Pass word	A Character	
Port number	1 Numerical Value	
PASV Mode	<input type="radio"/> Select	
Connection test	<input type="button"/> Execute	

	Symbols	References
I/F, USB settings		P.3-87
New line Code	<input type="text" value="○ Select"/>	
USB ID	<input type="text" value="1 Numerical Value"/>	
USB Drive mode select	<input type="text" value="○ Select"/>	
Date/Time settings		P.3-92
Date	<input type="text" value="1 Numerical Value"/>	
Time	<input type="text" value="1 Numerical Value"/>	
Apply	<input type="text" value="▶ Execute"/>	
Internet time	<input type="text" value="○ Select"/>	
NTP server	<input type="text" value="A Character"/>	
Time zone	<input type="text" value="○ Select"/>	
Synchronization interval	<input type="text" value="○ Select"/>	
Adjust mode	<input type="text" value="○ Select"/>	
Connection test	<input type="text" value="▶ Execute"/>	
OTHER Settings (1/2)		P.3-94
Power on start	<input type="text" value="○ Select"/>	
Start / Stop confirmation message	<input type="text" value="○ Select"/>	
AC line frequency (GL7-M)	<input type="text" value="○ Select"/>	
Temperature setting (GL7-M)	<input type="text" value="○ Select"/>	
Temperature unit	<input type="text" value="○ Select"/>	
Room temperature compensation	<input type="text" value="○ Select"/>	
Burnout	<input type="text" value="○ Select"/>	
Auto balance button (GL7-DCB)	<input type="text" value="○ Select"/>	
Strain unit (GL7-DCB)	<input type="text" value="○ Select"/>	
Demo waveform mode	<input type="text" value="○ Select"/>	
OTHER Settings (2/2)		P.3-96
LDC brightness	<input type="text" value="○ Select"/>	
Screen saver	<input type="text" value="○ Select"/>	
Key click sound	<input type="text" value="○ Select"/>	
Language	<input type="text" value="○ Select"/>	
Information	<input type="text" value="○ Select"/>	
Input setting (each CH)		P.3-98
Input		
<Strain unit>	To E	
<Acceleration unit>	To F	
Sensor setting		P.3-103
<Strain unit>	To E-1, E-2	
<Acceleration unit>	To F-1	
Auto balance adjustment (Strain unit)	<input type="text" value="▶ Execute"/>	
Factory Init.		

	Symbols	References
(Each Amplifier Module)		
Channel settings		
ALL		
Input	<input type="radio"/> Select	
Range	<input type="radio"/> Select	
Filter	<input type="radio"/> Select	
Span		
Upper limit/Lower limit	<input type="text" value="1 Numerical Value"/>	
Apply	<input type="button" value="Execute"/>	
Input settings (Each CH)		P.3-98
Input	<input type="radio"/> Select	P.3-114
Range	<input type="radio"/> Select	P.3-115
Filter	<input type="radio"/> Select	P.3-122
Slope	<input type="radio"/> Select	P.3-115
Scaling settings		P.3-124
Scaling	<input type="radio"/> Select	
Meas. Value (Upper/ Lower)	<input type="text" value="1 Numerical Value"/>	
Scal. Value (Upper/ Lower)	<input type="text" value="1 Numerical Value"/>	
Adjust (Meas. Value)	<input type="text" value="1 Numerical Value"/>	
Adjust (Scal. Value)	<input type="text" value="1 Numerical Value"/>	
Read current	<input type="button" value="Execute"/>	
Meas. Value	<input type="text" value="1 Numerical Value"/>	
Scal. Value	<input type="text" value="1 Numerical Value"/>	
Select (Categories)	<input type="radio"/> Select	
Select (Unit selection)	<input type="radio"/> Select	
Unit	<input type="text" value="A Character"/>	
Apply	<input type="button" value="Execute"/>	
Annotation	<input type="text" value="A Character"/>	P.3-125
Span		P.3-125
Upper/Lower	<input type="text" value="1 Numerical Value"/>	
Apply	<input type="button" value="Execute"/>	
Inter-CH operation settings		P.3-126
Inter-CH Op.	<input type="radio"/> Select	
Operation	<input type="radio"/> Select	
Scaling	<input type="radio"/> Select	
Calculation span (Upper level)	<input type="text" value="1 Numerical Value"/>	
Calculation span (Decimal point)	<input type="radio"/> Select	
Calculation span (Lower level)	<input type="text" value="1 Numerical Value"/>	
Select Unit(Categories)	<input type="radio"/> Select	
Select Unit(Select)	<input type="radio"/> Select	
Unit	<input type="text" value="A Character"/>	
Apply	<input type="button" value="Execute"/>	
Other settings		P.3-127
Waveform Color Setting		
Color settings	<input type="text" value="1 Numerical Value"/>	
Confirm	<input type="button" value="Execute"/>	
Thickness setting	<input type="radio"/> Select	
Perform auto zero ADJ.	<input type="button" value="Execute"/>	
Reset auto zero ADJ.	<input type="button" value="Execute"/>	
DC Strain Module to (E)		
Charge Module to (F)		
Trigger		to Trigger/Alarm settings
Alarm level settings		to (C)
Voltage Output module settings		Voltage Output module to (I)

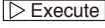
	Symbols	References
Swapping out the SD card		P.3-156
Screenshot		P.3-158
File name		
Name type		
File type		
Save		
Cursor		
Cursor position		P.3-159
Move to first		
Move to center		
Move to last		
Move to trigger		
Move to selected position		
Move position		
Move date/time		
Move		
Cursor sync		
A-cursor/B-cursor		
Call other cursor		
Data search		
Channel type		
Channel		
Mode		
Level		
Prev. search		
Next search		
Action screen		
Statistical calculation		

Symbols

References

P.3-103

E) Input selection setting <Strain unit>

E-1) <Strain gauge>

- Input
- Bridge type
- Number of wires
- Gauge resistor
- Sensor setting
 - Bridge power supply
 - Bridge voltage
 - Target bridge voltage

- Select
- Select
- Select
- Select
- Select
- Select
- Select

E-2) <Strain sensor>

- Input
- Number of wires
- Bridge resistor
- Sensor setting
 - Bridge voltage
 - Rated capacity
 - Decimal point
 - Rated capacity
 - Unit selection
 - Unit
 - Rated output
 - Decimal point
 - Rated output
 - Unit
 - Calibration coefficient
- TEDS settings
 - Read TEDS information
 - Release TEDS mode
 - Save TEDS information
 - File name
 - Naming method
 - Save
 - Read TEDS information
 - File name
 - Load

- Select
- Select
-
- Select
- Select
- Select A Character
- Select
-
- Select
-
-
-
- Select
-
-
-

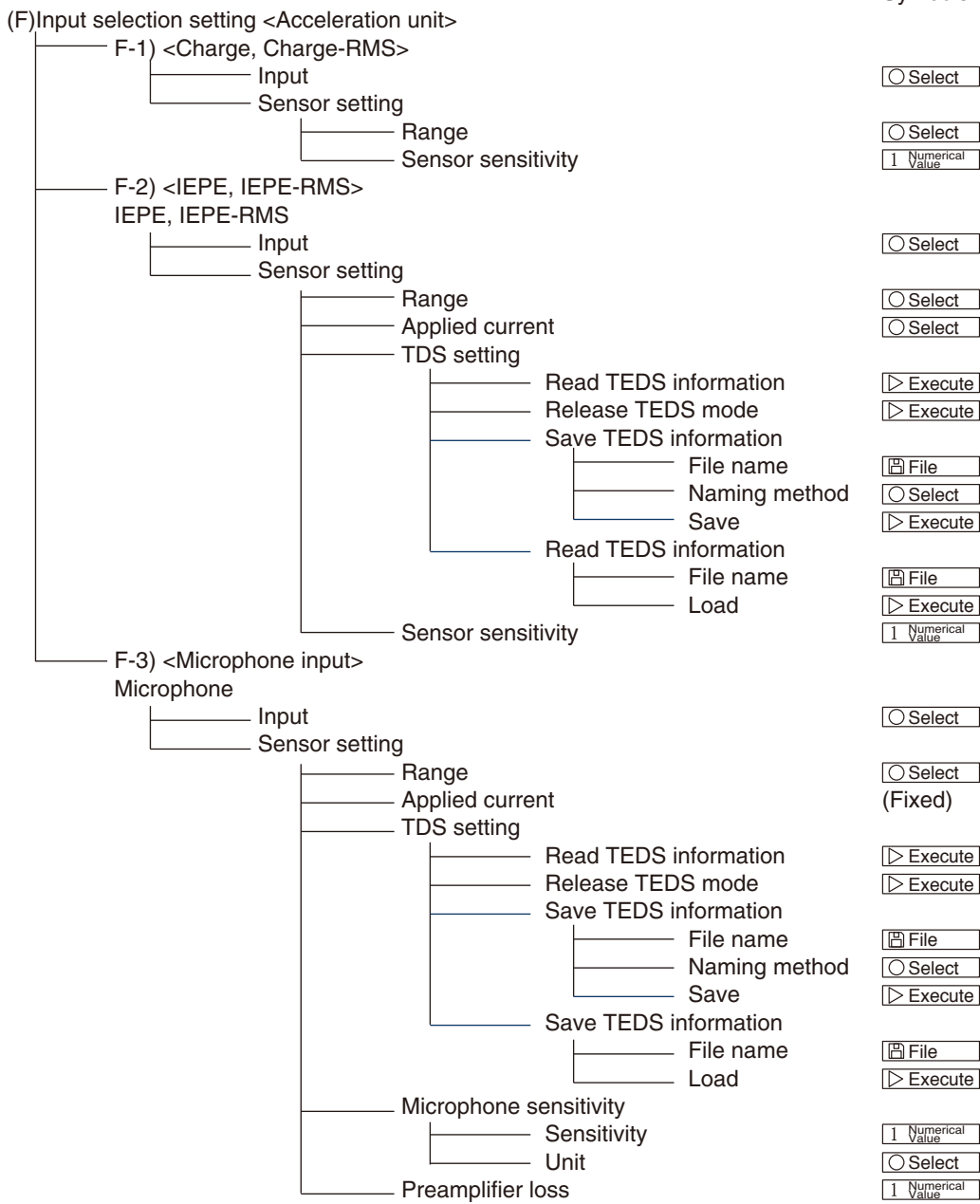

Symbols

References

G) Other <Strain unit>

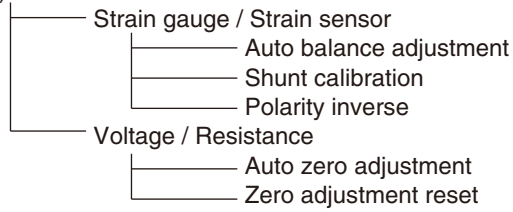

P.3-103

H) Other <acceleration unit>

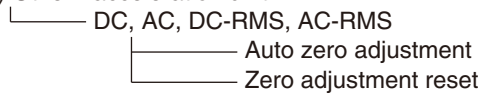

P.3-110

I) Voltage Output module

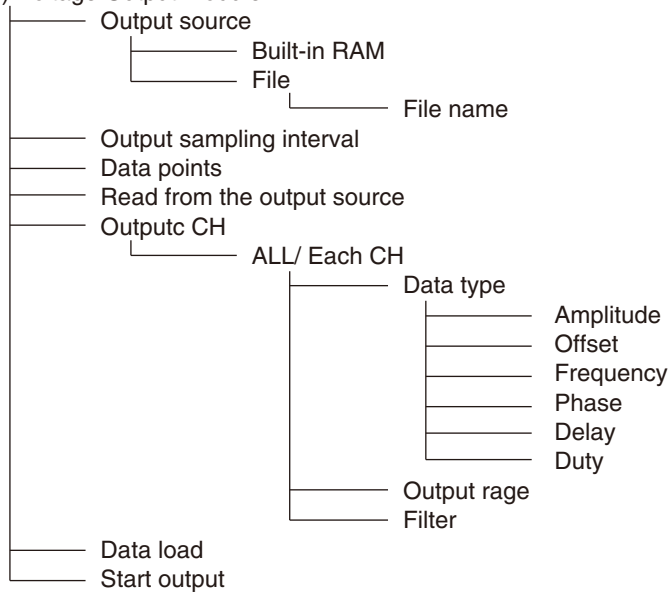

P.3-166

3.2 Touch-panel Functions

The GL7000 uses a capacitive touch-panel. Operations can be performed by pressing the screen with your finger.

Here, basic operations, numerical entry and other shared operations using the touch-panel are described. Since this is a capacitive touch screen, touching it with a pen or the like will yield no response. Please remove gloves etc. and operate it with your fingers.

Please note that operating the touch screen with a pointed object may damage it.

(1) Select a setting item

Touch an icon with your finger and it will change to the hierarchy screen below.

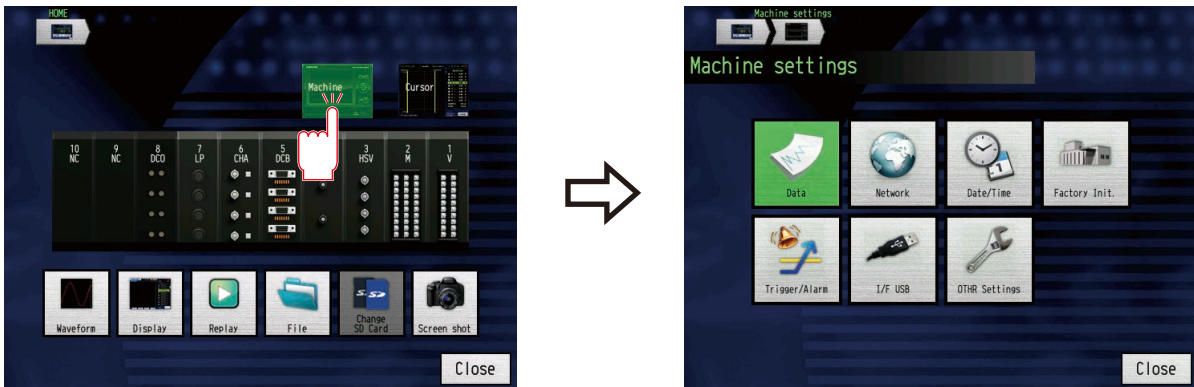

(2) Select a setting value

For selecting a setting value, it will be selected, it will turn green if touched once.

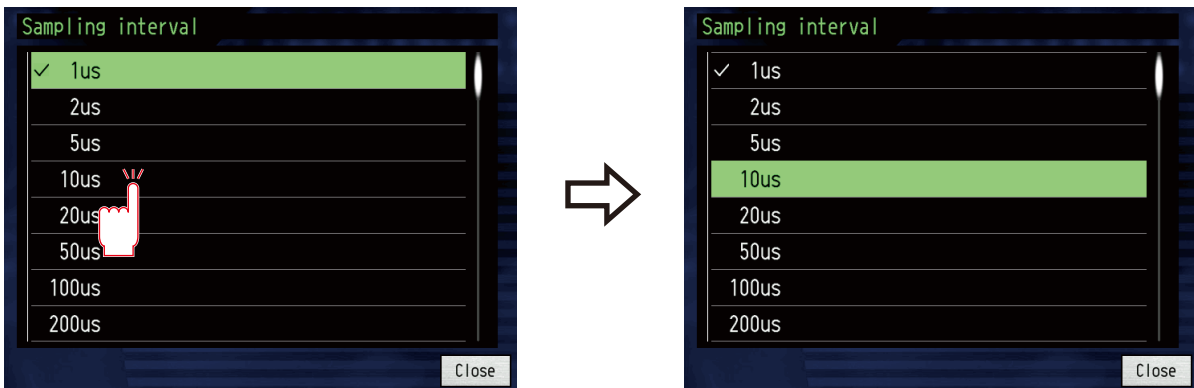

By touching a green item again, the selection is confirmed and set (In this example, it returns to the previous screen after confirmation).

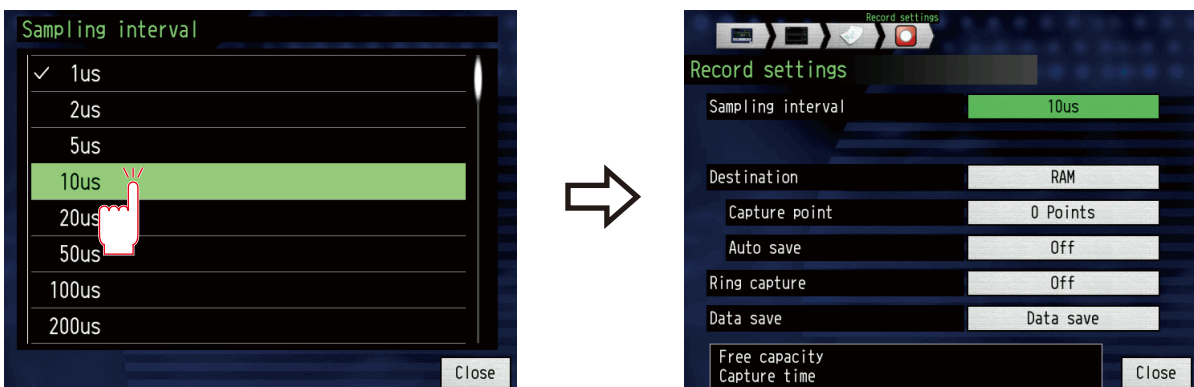

Should there be so many items that they cannot be displayed on one screen a scroll bar will be displayed on the right side. The white knob on the scroll bar displays the current display position.

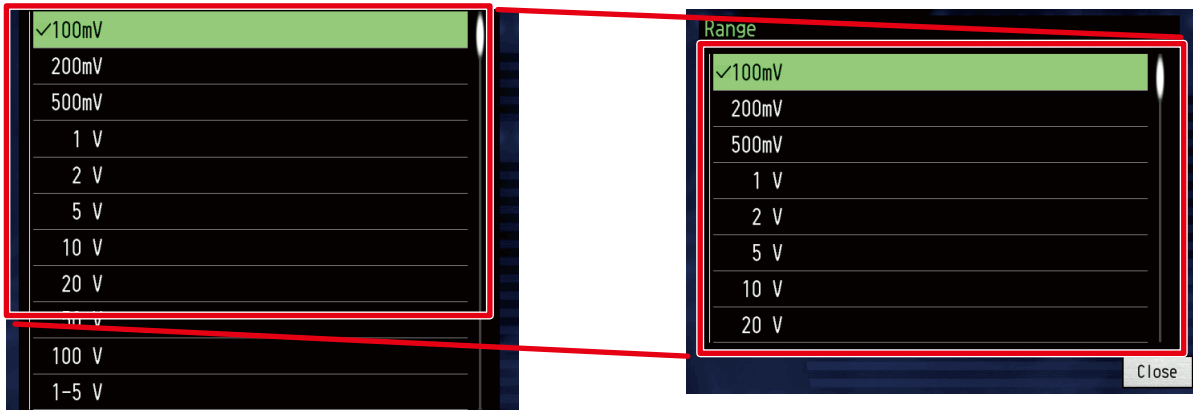

By touching a spot with no knob, or dragging the knob (keeping the finger pressed down and move by tracing your finger), the position of the knob can be changed and the display can be scrolled.

<Touch a Knob>

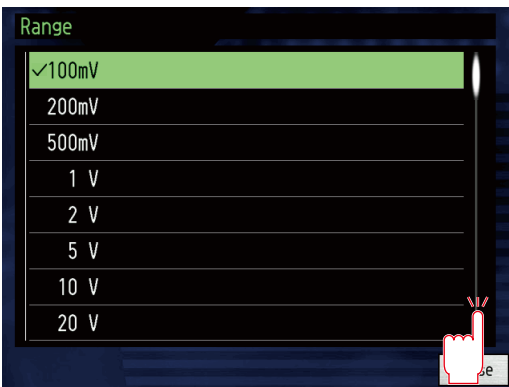

<Drag a Knob>

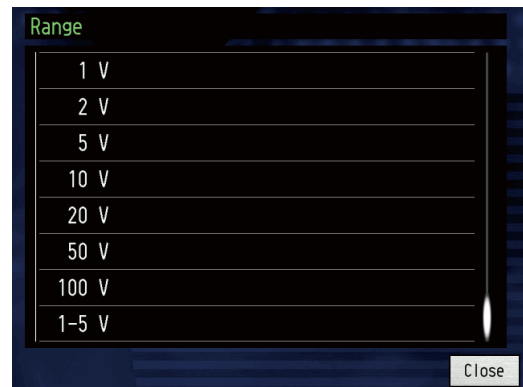
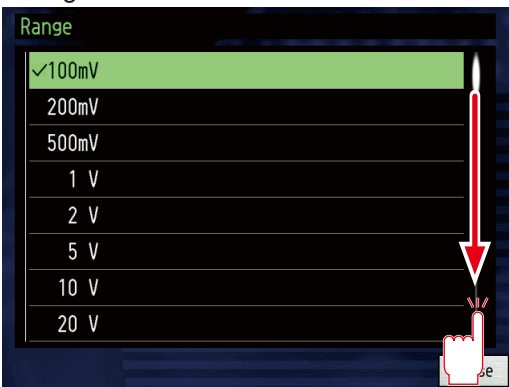

CHECKPOINT

You can also scroll by dragging within the frame in which the selection items are displayed.

3.3 Explanation of the Common Process Screens

This explains the common process screens such as the numeric entry screen and the file box screen. These screens appear on various places of the settings menu, such as when entering numerical values and characters.

(1) Numerical entry

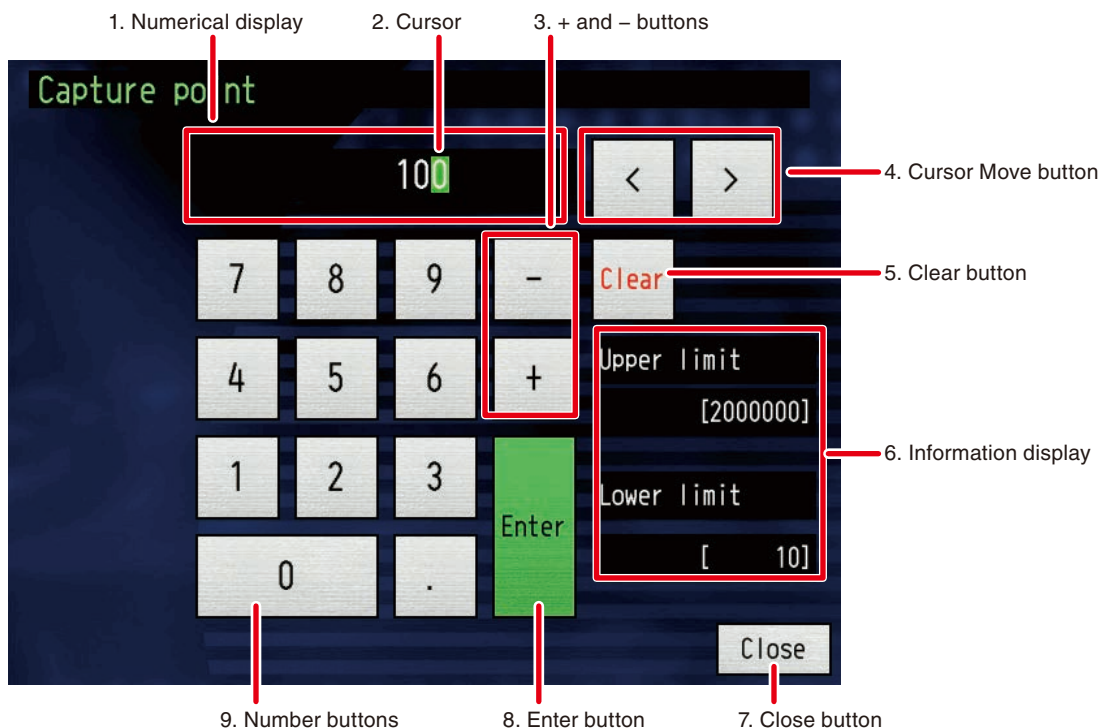

1. Numerical display

The entered values are displayed.

2. Cursor

The green square box is the cursor for displaying the position for input.

3. + and - buttons

Used when changing the plus/minus sign of the numerical value.

4. Cursor Move button

The cursor can be moved left and right. With this button, the cursor can be moved to the position you want to correct, and pressing the numeric button the input will change.

5. Clear button

Entered value is cleared to zero.

6. Information display

Information such as upper and lower limit values are displayed.

7. Close button

This screen is closed, returning to the previous screen. Entered values are cleared.

8. Enter button

Entered values are confirmed, returning to the previous screen.

9. Number buttons

This button is used to enter the values with the cursor.

<EX. 1> : Enter 123.

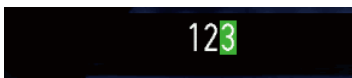

Press the 1, 2 and 3 keys in order.
Press ENTER key at the end.

CHECKPOINT

When an entered value exceeds the upper or lower limit value, the message below will be displayed. Once this message is closed by pressing close once, please set a value that lies between the upper and lower limit values.

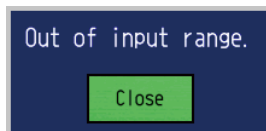

<EX. 2>: Change 2000 into 2500.



Press the < button twice.



Press the 5 key.
Press ENTER key at the end.
The Number button is closed, and it will return to the settings screen.

(2) Enter a character

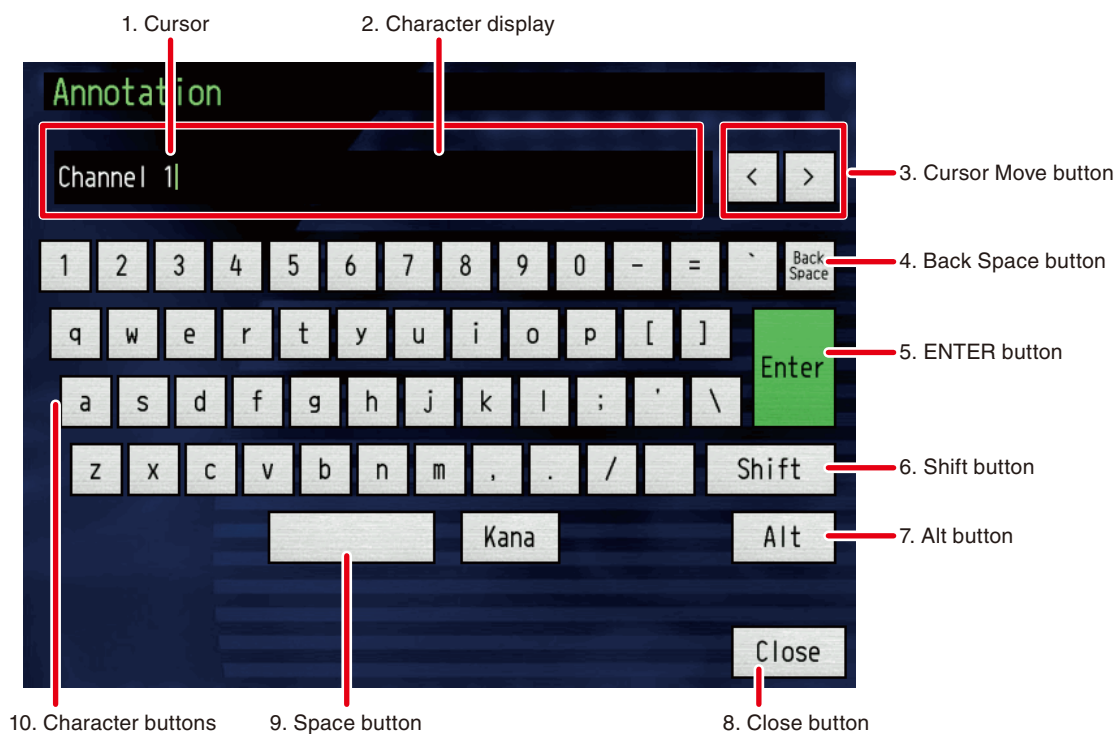

1. Cursor

The green vertical line is the cursor, it displays the input position.

2. Character display

Characters are displayed in this box during entering.

3. Cursor Move button

The cursor can be moved left and right. Moving the cursor with this button and pressing a character button, the character is inserted in that position.

4. Back Space button

This button is used to delete one character to the left of the cursor.

5. ENTER button

Entered characters are confirmed, returning to the previous screen.

6. Shift button

Changes the keyboard. If it is set to "alphanumeric", changes between upper-case and lower-case letters.

7. Alt button

Using the Alt button, you can to switch between JIS keyboard layout and Alphabetical order as shown in the figure below.



<JIS keyboard layout>



<Alphabetical order>

8. Close button

Closes the current screen and returns to the previous screen. Any entered characters are cleared.

9. Space button

Enters a space. From the cursor, if there is a character to the right, it's shifted to the right.

10. Character keys

Enters a character to the left side of the cursor. From the cursor, if there is a character to the right, it's shifted to the right.

11. Character key

Enters the characters to the left of the cursor. If there are the characters to the right, shift to the right with the cursor.

(3) File operations

This explains, specifying file names and copying operations for each menu and settings.

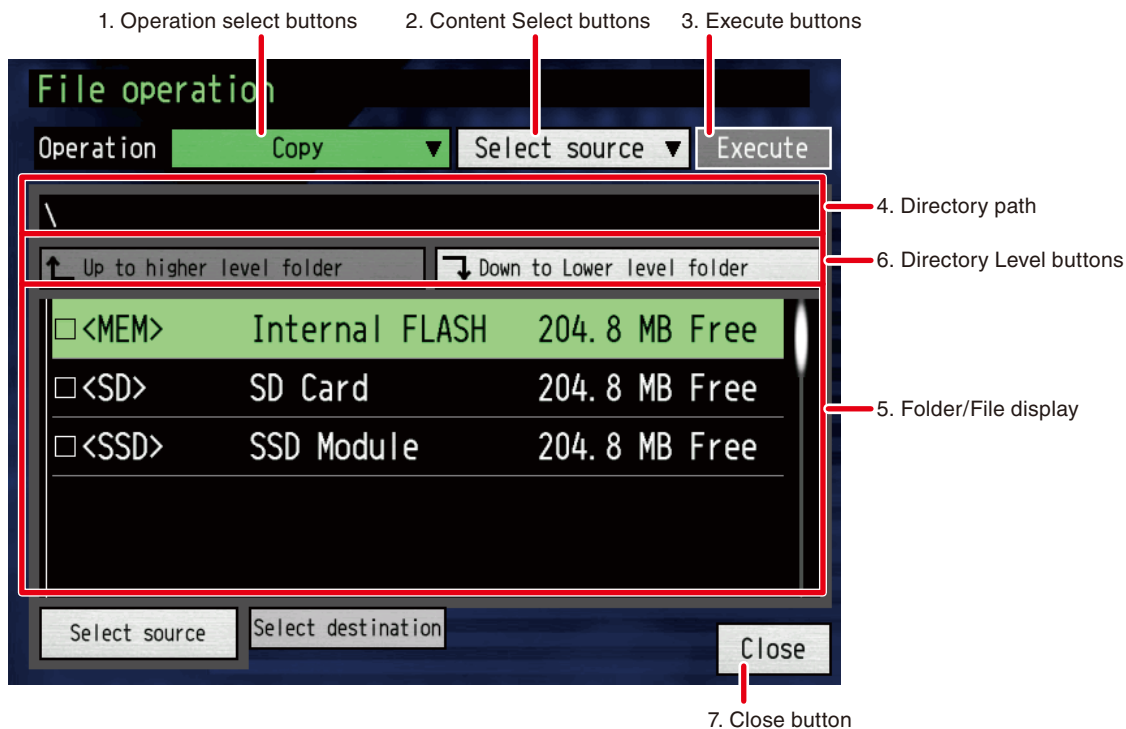

1. Operation Select buttons

These buttons are used select operations.

Item Select	Description
Property	Details for the files and folders are indicated.
Select	Selects a file or folder to write data to.
Cerate new file	Creates a new file.
Create new folder	Creates a new folder.
Rename	Changes a file or folder's name.
Copy	Copies a file or folder.
Delete	Deletes the file or folder.
Sort	Changes the display order for files and folders.
View	Changes the contents displayed for a file and folder.
Format	Initializes the disk.

2. Content Select buttons

This button may be displayed depending on the selected content.

Selection button	Item select	Description
Copy	Select source	Selects a copy source.
	Select destination	Selects a copy destination.
Sort	Alphabetical	Files/folders are displayed in name order.
	Rvse alpha	Files/folders are displayed in reverse name order.
	Oldest first	Files/folders are displayed in order of how old they are.
	Newest first	Files/folders are displayed in order of how new they are.
View	With size	Displays the file name with file size.
	With date	Displays the file name with the last updated date and time
	Filename only	Displays the file name only.
Format	Quick	Pressing the Execute button performs a quick format.
	Normal	Pressing the Execute button performs a normal format.

3. Execute buttons

Pressing these buttons perform specific operations.

Item select	Description
Property	Displays the information about the drive, folder and file <Drive> Displays the drive name, the file system, open memory, total memory and volume name. <Folder> Displays folder name, creation date, and time of creation. <Data File> Displays the model name, the sample interval, the data points and trigger time.
Create new file	Creates a file for data recording or a file for setting conditions. Opens the file creation Text entry screen and creates a file under the current displayed drive or folder with the name entered. For how to enter characters, see "(2) Enter a character" on page 3-30.
Create new folder	Creates a folder. Opens the folder creation Text entry screen and creates a folder under the current displayed drive or folder with the name entered. For how to enter characters, see "(2) Enter a character" on page 3-30.
Rename	In File operation screen, change the name of the selected file or folder. When this button is touched, already entered name is display. Change this name to new one. For how to enter characters, see "(2) Enter a character" on page 3-30. * The file will have the extension. Do not change the extension.
Copy	Copies the selected file/folder to the specified copy destination (drive or folder). Use the pre-select button to select the original and the copy destination.
Delete	Deletes the selected files/folders.
Format	Formats the selected drive using set contents. Use the pre-select button to select the type of format.

4. Directory path

The path to the drive, folder or file that is currently active is displayed.

5. Folder/file display

A list of drives, folders and files is displayed.

6. Directory Level buttons

From the currently displayed folder, moves either 1 directory up or 1 directory down.

7. Close button

The current screen is closed, returning to the previous screen.

<Ex. 1>: Create a folder named test in the root of the built-in flash memory.

("Home" → "Machine" → "Data" → "Capture" → (Built-in flash memory as the recording destination) → "Filename")

(1) Touch where <MEM> is displayed in the file name.

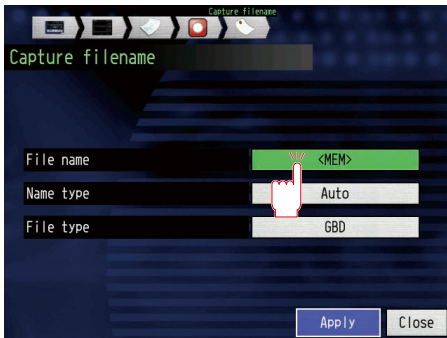

(2) Touch the "<MEM> Internal FLASH".

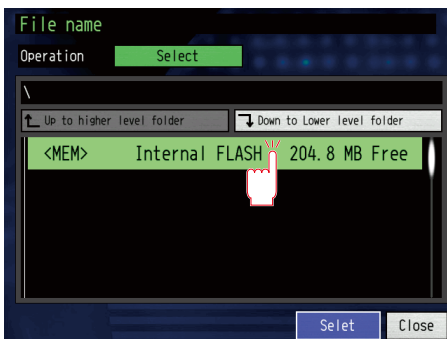

(3) Touch the "Select".

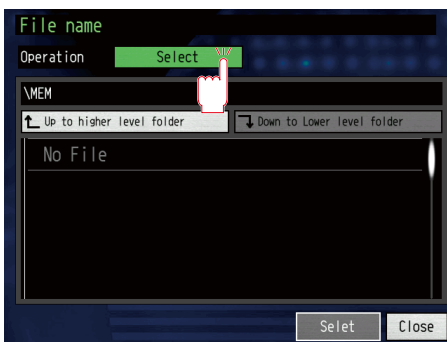

(4) Touch the "Create new folder" twice.

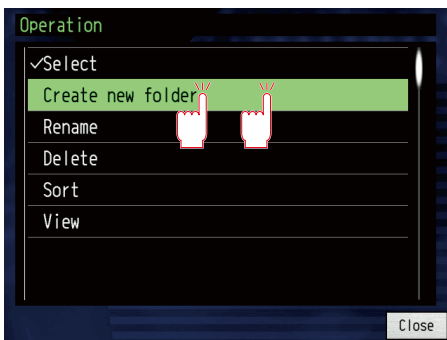

(5) Touch the "Execute"

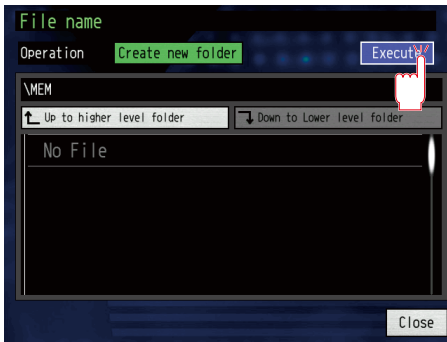

(6) The keyboard is displayed. Enter "test", and then touch the "Enter".



(7) <test> folder is created.

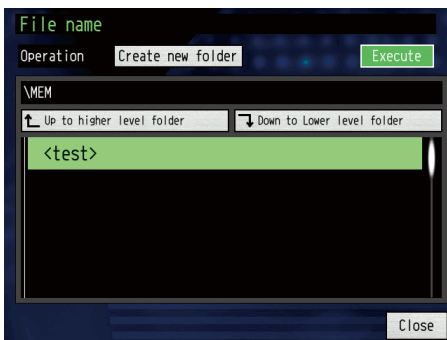

<Ex. 2>: If the automatic naming is used, set as the data is recorded in the Test folder is below the root of the built-in flash memory.

("Home" → "Machine" → "Data" → "Capture" → "Filename")

(1) Touch where <MEM> is displayed in the file name.

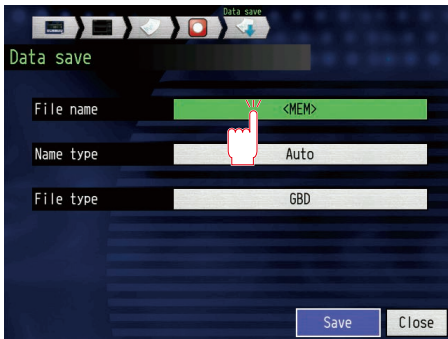

(2) To move to the subdirectory, touch the "<MEM> Internal FLASH".

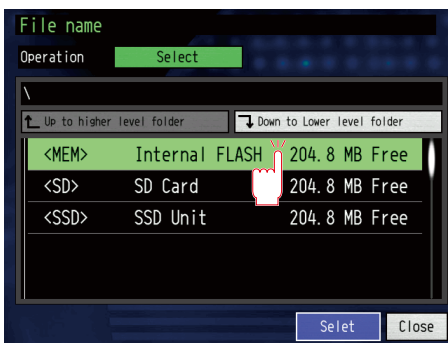

(3) Touch the <Test> folder and then the "Select" button.

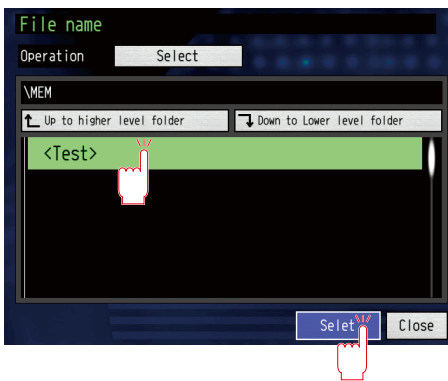

(4) Touch the "Apply". This procedure is complete.

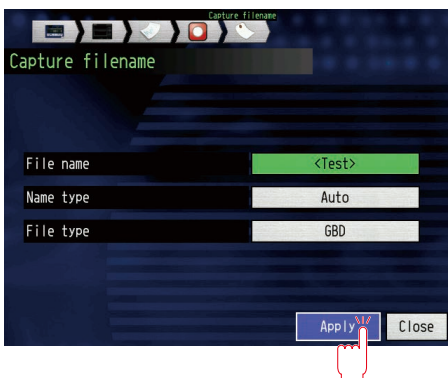

<Ex. 3>: If any naming is used, create the "test.GBD" file in the Test folder is below the root of the built-in flash memory, and then set as the data is recorded in the "test.GBD" file.

("Home" → "Machine" → "Data" → "Capture" → "Filename")

(1) Touch the "Auto" for the Name type

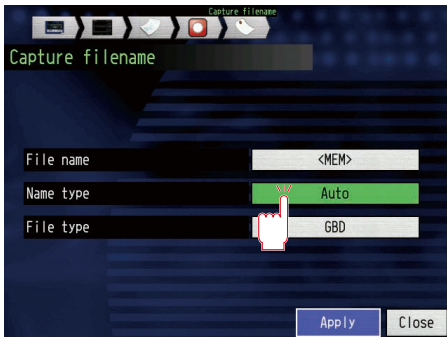

(2) Touch the "User" twice.

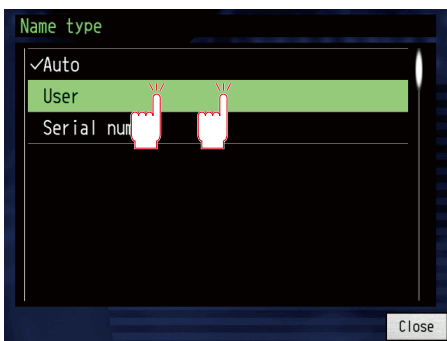

(3) Touch the "DEFAULT.GBD" for File name

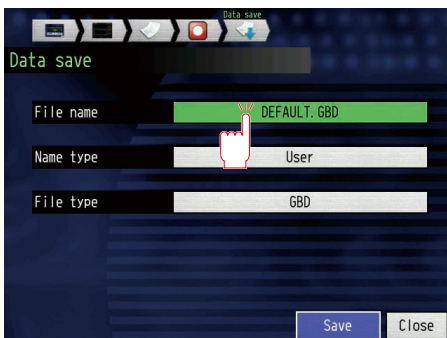

(4) Touch the "<MEM> Internal FLASH"

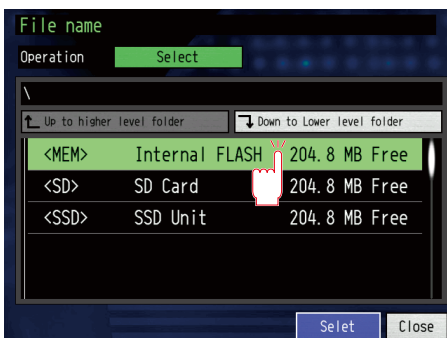

- (5) To move to the subdirectory, touch the <test>.

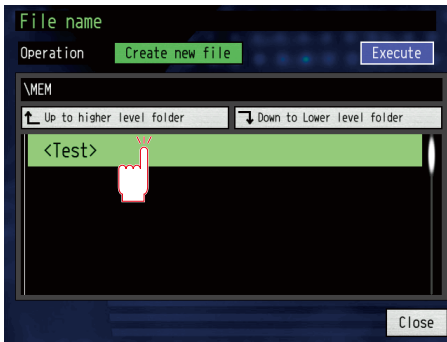

- (6) Touch the "Select".

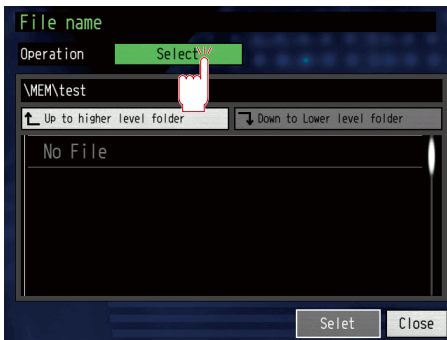

- (7) Touch the "Create new file" twice.

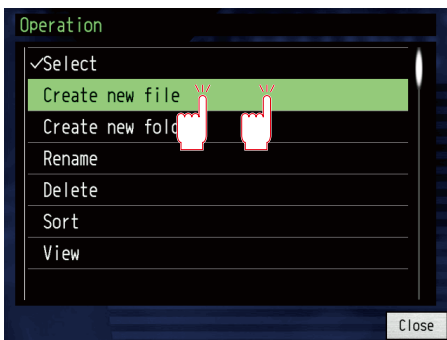

- (8) Touch "Execute"

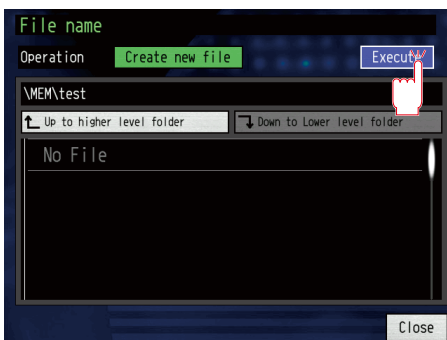

(9) The keyboard is displayed. Touch the "test", and then touch the "Enter".



(10) The file name has been changed to the test.GBD. Touch the "Apply". This procedure is complete.

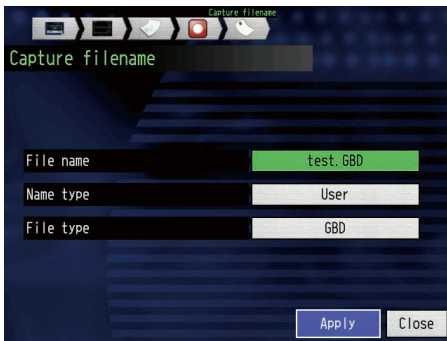

<Ex. 4>: Copies the test.GBD file in the <Test> folder to the Root.

"Home" → "File" → "File operation"

(1) Press the "Property".

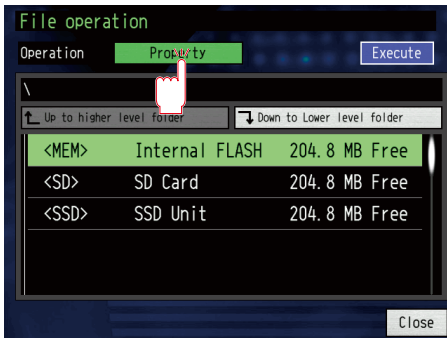

(2) Press "Copy" twice.

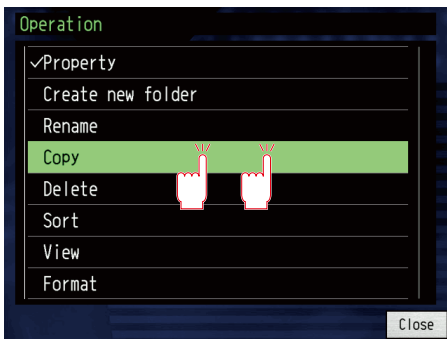

(3) Press "Down to Lower level folder" when <MEM> is selected (thus green).

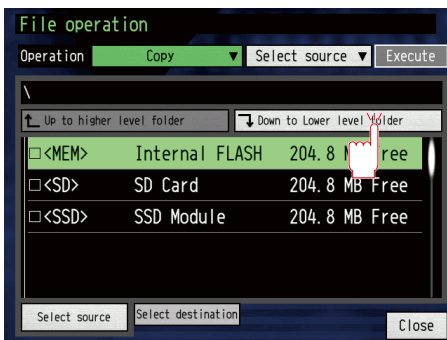

(4) Press "Down to Lower level folder" when <Test> is selected (thus green).

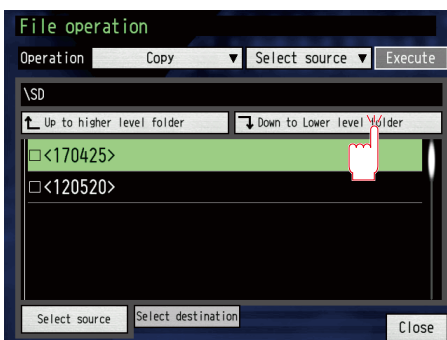

(5) Press and select "test.GBD". (A tick is displayed to the left).

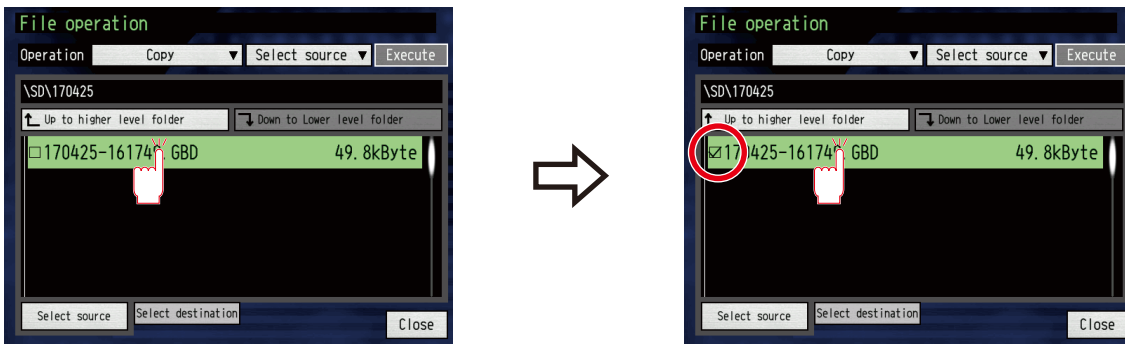

* When copying the multiple files at same time, touch the files to be copied to place a check mark.

(6) Press select "Select source".

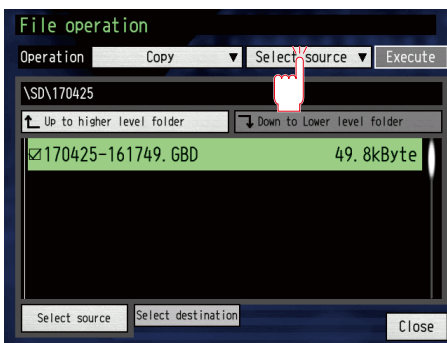

(7) Press select "Select destination" twice.

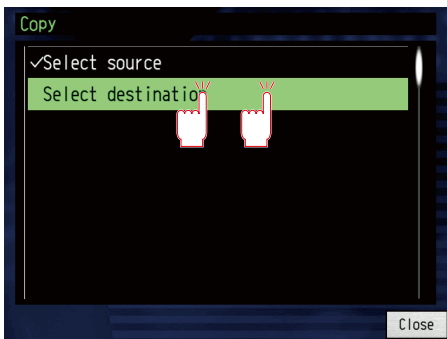

(8) Select "<MEM> Internal FLASH", and press "Execute".

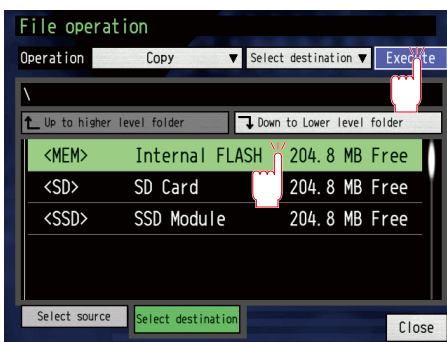

(9) A confirmation message will appear so press "Yes".

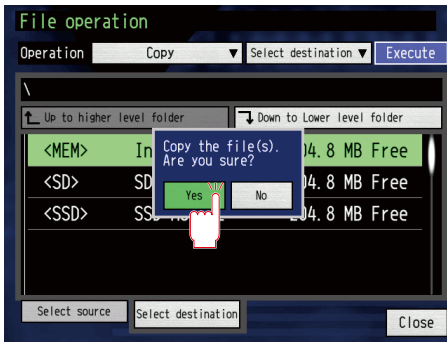

Copy is executed and the operation is completed.

3.4 Key Operations

Here the key functions will be explained.

The GL7000 is fundamentally operated by the touch-panel, but opening menus and some operations can be done with the keys. The Start/Stop function or key lock can only be operated by keys.

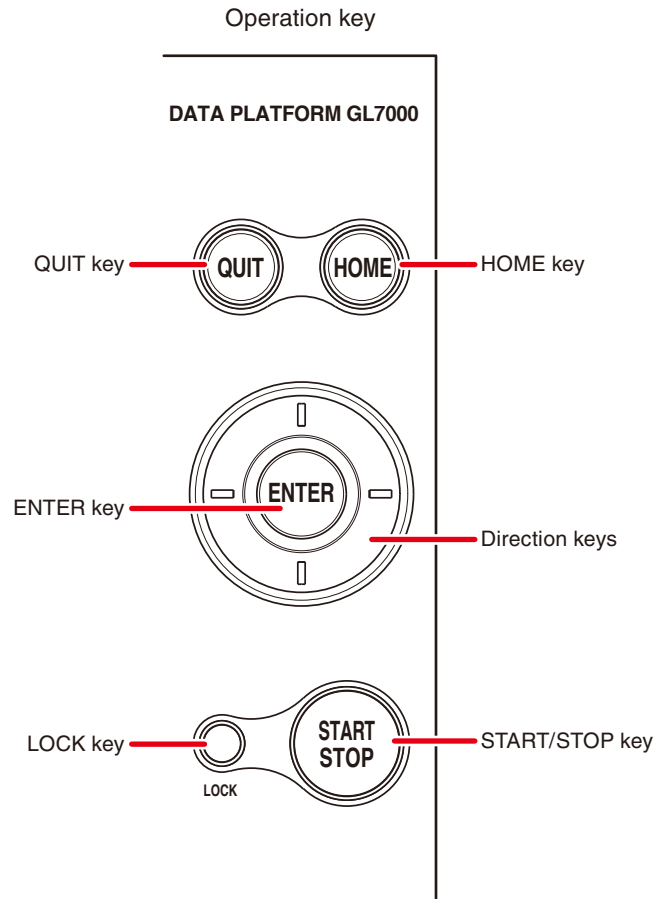

(1) HOME

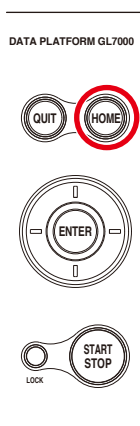

The HOME menu is displayed when this key is pressed. For details, refer to "(2) HOME screen" on page 3-9.

By pressing and holding the HOME key during controlling in PC software GL-Connection Ver. 2.20 or later, remote lock is released and the settings can be changed with GL7000. To return to the remote locked state, press and hold the HOME key again. For this function, refer to the GL-Connection User's Manual.

(2) Direction keys



These keys are used mainly for the following operations:

- Cursor movement in MENU settings.
- Cursor movement during replay.
- Analogue CH movement for "waveform + digital screen", "digital + operation screen" (The up and down directional keys)
- Changing the CH to display for "digital + operation screen" (The up and down directional keys)

(3) ENTER

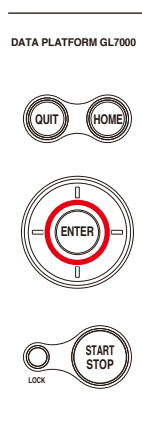

These keys are used for the following operations mainly.

- Confirming set items, opening sub-menus, etc., in the MENU settings.

(4) START/STOP (USB DRIVE)

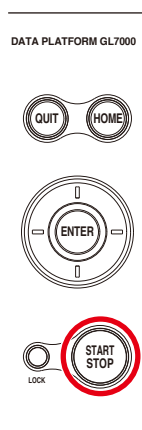

This key performs the following 2 functions:

- During free running, starting a recording.
- During recording, stopping the recording.

Using the USB cable between the GL7000 and computer. By turning on the power while pressing the Start/Stop key, it goes into USB Drive Mode.
For more information on USB Drive Mode, see the next page.

By pressing and holding the START/STOP key during controlling in PC software GL-Connection Ver. 2.20 or later, you can start capturing and stop capturing from this GL7000. For this function, refer to the GL-Connection User's Manual.

USB Drive Mode

In "USB Drive Mode", you can see the "Built-in flash memory", "SD card", or "SSD" as an external storage device on the computer.

Because it's recognized as a removable drive, file transfer and deletion can be done easily.

<When using the Display module>

- (1) Using the USB cable, connect between the GL7000 and your computer.
- (2) Turn on the power while holding down the "START/STOP" key on the GL7000.
- (3) An external storage medium will be recognized by the PC and data may be transferred.

* While in "USB Drive Mode", the GL7000 will show the following:

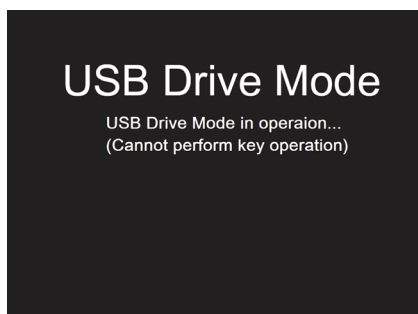

<When Display Module is not used>

When the Display Module is not used, USB Drive Mode can be used by following the procedures below.

- (1) Please connect the GL7000 to the PC with a USB cable.
- (2) Make sure that the power switch is turned off. Remove the face cover, and then slide the slide switch to ON position.

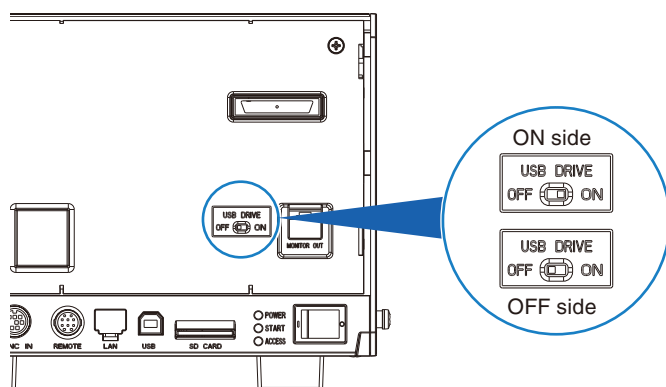

- (3) Turn on the machine. When powered up, external memory will be recognized on the PC allowing file exchange.

⚠ CAUTION

- When clearing the USB Drive Mode, turn off the power once, slide the switch on the side to "OFF", and turn the power back on.
- When using the USB Drive Mode, all operations, such as data recording and data replay, temporarily stop functioning.
- When using the USB Drive Mode, the USB driver must be installed on the PC.
The "USB driver" and "USB driver installation instructions" are stored on the attached CD. Please install according to the instructions.
Location of Instructions:
D:¥USB Driver¥Japanese¥GL-USB-UM15X.pdf (D:¥ is the drive where the CD is inserted. It changes depending on the computer.)

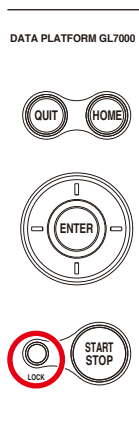
(5) LOCK

Pressing this key for 2 seconds or more lets you set or clear the key-lock. A password can also be set to clear the key-lock. For details, see the "Set and clear the key-lock with the password" on page 3-47.

(6) QUIT (LOCAL)

These keys are primarily used for the following functions:

- In the MENU settings, cancels the settings selections.
- Clears the remote status (where the keys are not functioning) depending on the interface arrangement.
- Closes the MENU screen.
- Ends data replay.
- For the Alarm settings, when "Alarm hold" is set to On, the retained alarms are cleared.

CHECKPOINT

- Pressing the QUIT key on the screen that icons and buttons are displayed will close all menus and open the waveform display.
- Pressing the QUIT key on the screen that setting values are selected will return to the previous screen.

Set and clear the key-lock with the password

A password can be set to clear the key-lock (Password is not set by default.).

< Operation >

- (1) Set a password.
Simultaneously pressing "ENTER" and "LOCK" keys displays the following password setting screen.
Enter a four-digit password.

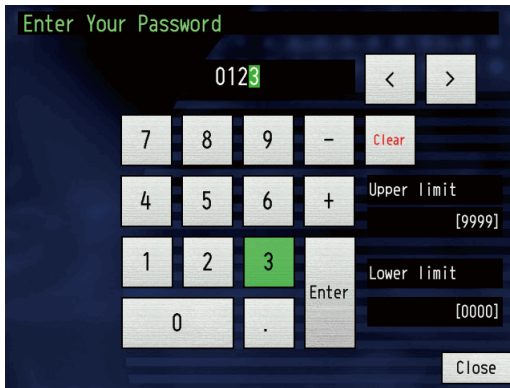

By touching the Enter key at the end, the password is confirmed.

For the "0000", it is operated without a password.

If you forget your password, please call our Customer Care Center and ask for a master password.

- (2) Set the key-lock.
Touch the LOCK key for 2 seconds or more.
- (3) Clear key-lock.
Touch the LOCK key for 2 seconds or more.
The following password setting screen is displayed. Enter the password.

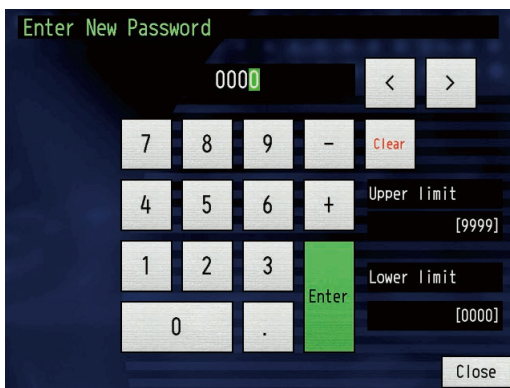

If the password is wrong, key-lock cannot be cleared.
Key-lock is maintained even if the power is turned off.

3.5 Description of Each Operating Mode

Each operation status can be checked with the "Simple message display".

Action	Action name	Simple message display
Free running	When neither being launched nor when a recording is performed.	Free running
Recording	Data is being recorded to the various storage device.	RAM recording, Memory recording, SD card recording, SSD recording.
2 screen replaying	Replay of the current waveform display and data during recording.	Memory recording, SD card recording, SSD recording.
Replaying	Replaying already recorded data.	Replaying RAM, Memory Review, Replaying SD card, Replaying SSD.

<Action status transition diagram>

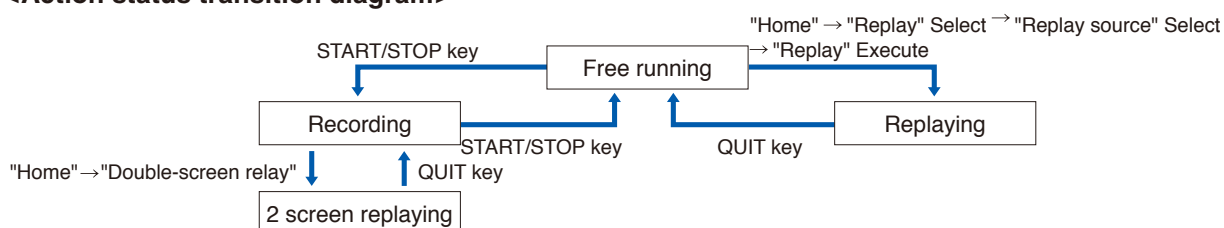

CHECKPOINT

- When capturing to the built-in RAM, "Double-screen replay" cannot be selected.
- When the sample interval is less than 100 ms, "Double-screen replay" is not available.
- When the recording format is "CSV", "Double-screen replay" is not available.
- When the sampling interval used in recording with the built-in RAM is 500 μs or less, the recording stops, and then it is automatically replayed.

(1) Free running

During free running, mainly settings for recording are being carried out.
The current input signal can be accessed as a waveform or a digital value.

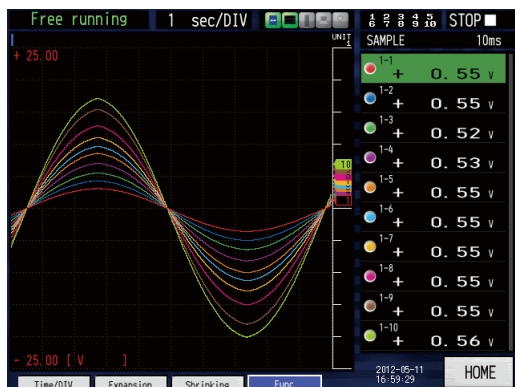

"Func" button

Touch the "Func" button to display the function menu and access multiple functions. Also, the touched line is displayed at the bottom of the screen.

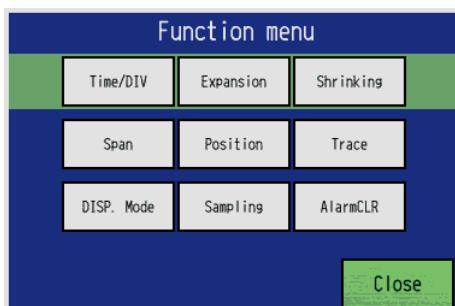

Item Select	Description
Time/DIV	Change the time axis scale of the waveform. (See page 3-135)
Expansion	Expand the time axis scale of the waveform. (See page 3-135)
Shrinking	Shrink the time axis scale of the waveform. (See page 3-135)
Span	Change the amplitude of the waveform. (See page 3-135)
Position	Change the display position of the waveform. (See page 3-135)
Trace	Set the waveform display to On / Off. (See page 3-135)
Display mode	Change the display mode. (See page 3-137)
Sampling	Change the sampling rate. (See page 3-58 (1))
AlarmCLR	When "Alarm is held" is set in the alarm setting, the held alarms are cleared. (See page 3-6)

Possible main actions during free running

Changing the measurement conditions settings	Various measuring conditions can be set (See page 3-58).
Waveform control	The waveform position can be moved, and zoomed in or out (See page 3-135).
Change the display mode	Y-T, Y-T (all screens), logger, XY, FFT displays can be switched. (See page 3-137).
Clearing the alarm	If an alarm is set, it may be cleared. (See page 3-6).
File operations	Various file operations can be performed (See page 3-32).
Data replay	Recorded data can be replayed (See page 3-152).
Changing the timescale	Changes timescale on the time axis (See page 3-135).

(2) Recording

Normal capturing

During recording, data is recorded to the built-in RAM, the built-in flash memory, the SD card, or SSD. Recording settings can not be changed.

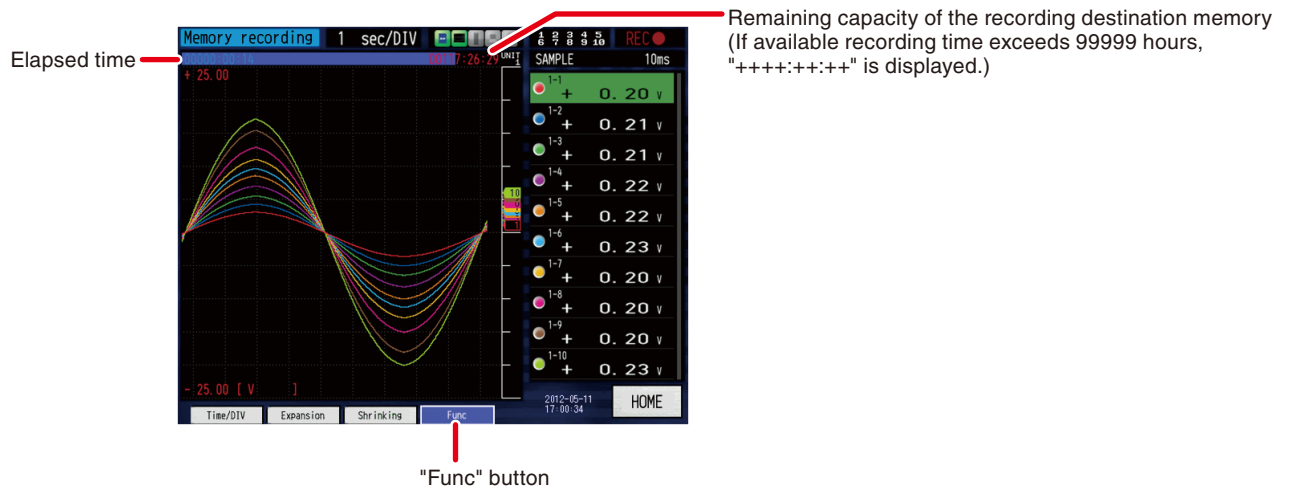

Touch the "Func" button to display the function menu and access multiple functions. Also, the touched line is displayed at the bottom of the screen.

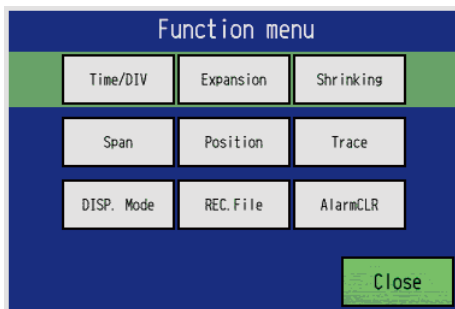

Possible main actions during recording

Confirm Settings	The recording settings can be viewed.
Waveform Operations	Waveform position can be moved or zoomed in or out (See page 3-135).
Change display mode	Y-T, Y-T (all screens), logger, XY displays can be switched (See page 3-137).
Clearing the Alarm	If an alarm is set, it can be cleared (See page 3-6).
2 Screen Replay	The waveform of the file being recorded can be compared with a waveform recorded in the past using two screens. 2 Screen Replay may not be useable depending on the sampling rate, recorded target and settings. Please see p3-52 "2 Screen Replay for details".
Changing the timescal	The timescale on the time axis can be changed (See page 3-135).

Capturing with dual sampling

When recording with dual sampling, the data is recorded in the built-in flash memory or SD card in Current recording (low-speed recording), and the data is recorded in built-in RAM or SSD Module in Event recording (high-speed recording).

Recording settings cannot be changed during recording.

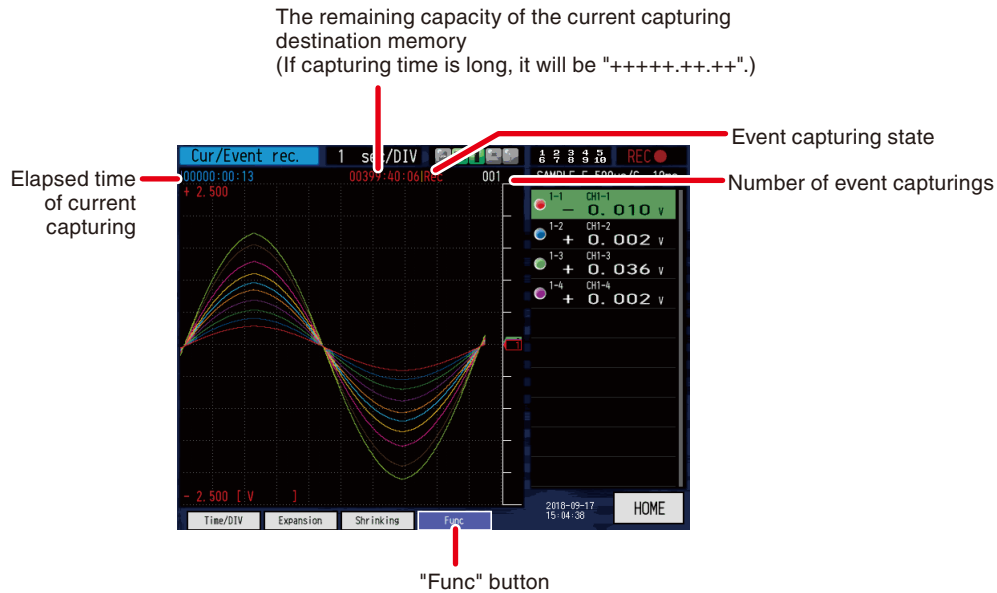

Touch the "Func" button to display the function menu and access multiple functions. Also, the touched line is displayed at the bottom of the screen.

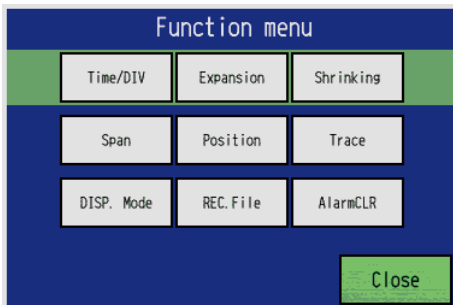

Main actions available during capturing

Confirming setting conditions	The setting conditions during capturing can be viewed.
Waveform operation	The waveform position can be moved or the waveform can be expanded / shrunk. (See page 3-135)
Changing display mode	Y-T, Y-T (full screen) and logger can be switched. (See page 3-137)
Clearing alarm	When alarms are held, you can clear them. (See page 3-6)
Changing time scale	The timescale on the time axis can be changed. (See page 3-135)

(3) 2 screen replaying

The current waveform being recorded and a waveform recorded in the past can be compared using double-screen.

The double-screen replay can be used if the sampling interval is 100 ms or more and the recorded file is in the "built in flash memory", "SD card" or "SSD".

The double-screen display can be changed by pressing "Home" > "double-screen replay" while recording.

The waveform display on the right side is the currently recording data, while already recorded data is displayed on the left. For the already recorded data, by moving the cursor with the direction keys (<◀▶>) or by dragging on the screen, it is possible to check the digital value.

To return single-screen, touch the "Quit".

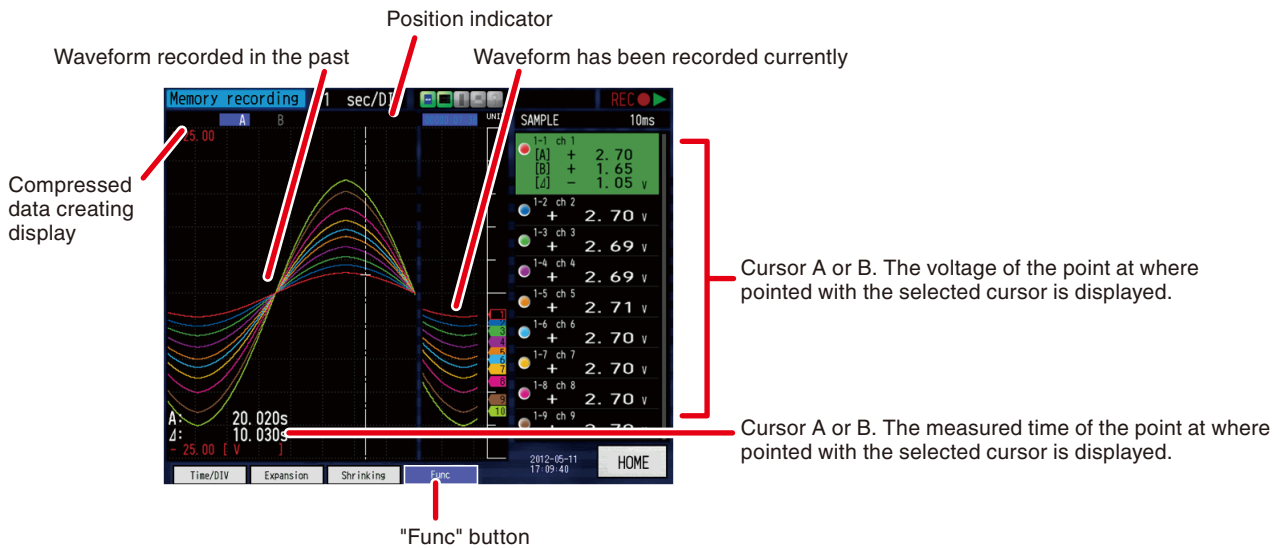

Touch the "Func" button to display the function menu and access multiple functions. Also, the touched line is displayed at the bottom of the screen.

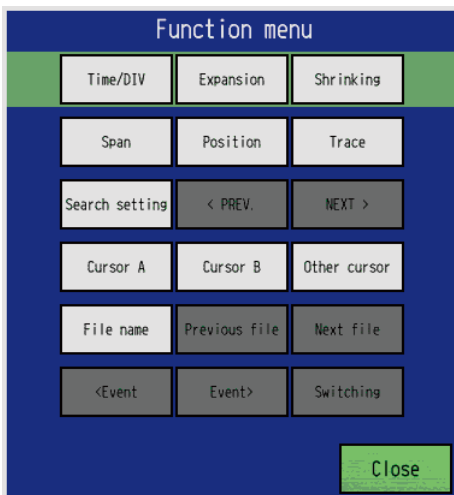

Item Select	Description
Time/DIV	Change the time axis scale of the waveform. (See page 3-135)
Expansion	Expand the time axis scale of the waveform. (See page 3-135)
Shrinking	Shrink the time axis scale of the waveform. (See page 3-135)
Span	Change the amplitude of the waveform. (See page 3-135)
Position	Change the display position of the waveform. (See page 3-135)
Trace	Set the waveform display to On / Off. (See page 3-135)

Item Select	Description
Search setting	By setting conditions, you can search for data that is satisfied the conditions. (See page 3-161).
Cursor A	Switch to cursor A.
Cursor B	Switch to cursor B.
Other cursor	Call the other cursor.
File name	Display the file name.

Possible main actions during 2 screen replay

Confirm Settings	The recording settings can be viewed.
Waveform Operations	Waveform position can be moved or zoomed in or out (See page 3-135).
Changing the timescale	The timescale on the time axis can be changed (See page 3-135).
Moving the Cursor	The cursor can be moved to a designated place (See page 3-159). When the left edge of the position indicator touched, "Move to first", and when the right edge of the position indicator touched, "Move to last".
Copy screen (Screenshot)	The current waveform displayed is saved with a BMP or PNG format (See page 3-158).
Data save	All the data or the data between cursors can be saved during replaying on the double-screen.

CHECKPOINT

- When replaying with the double-screen, the historical data is displayed with thinning temporarily. In this case, a red line is displayed while creating compressed data. (As soon as the compressed data is created, it is displayed.)
- When the recording format is "CSV", "Double-screen replay" is not available.
- "Double-screen replay" cannot be selected during dual sampling capturing.
- "Double-screen replay" cannot be selected during ring relay capturing.

To save the data during replaying on the double-screen

The recording data can be saved during replaying on the double-screen.

When selecting "HOME" → "File" → "Data save" during replaying on the double-screen, the Data save screen is displayed. The data is saved by touching "Save" after entering the file name, naming method, file format, and saving range.

For more information about the data save, see "(18) Data save" on page 3-153.

(4) Replaying

Displays the recorded data.

By pressing "Home" → "Replay" and selecting a data, the data can be replayed.

(Please see p3-152 "(16) Replay setting screen (Data relaying screen)")

Normal replay

In normal replay, one captured file is replayed.

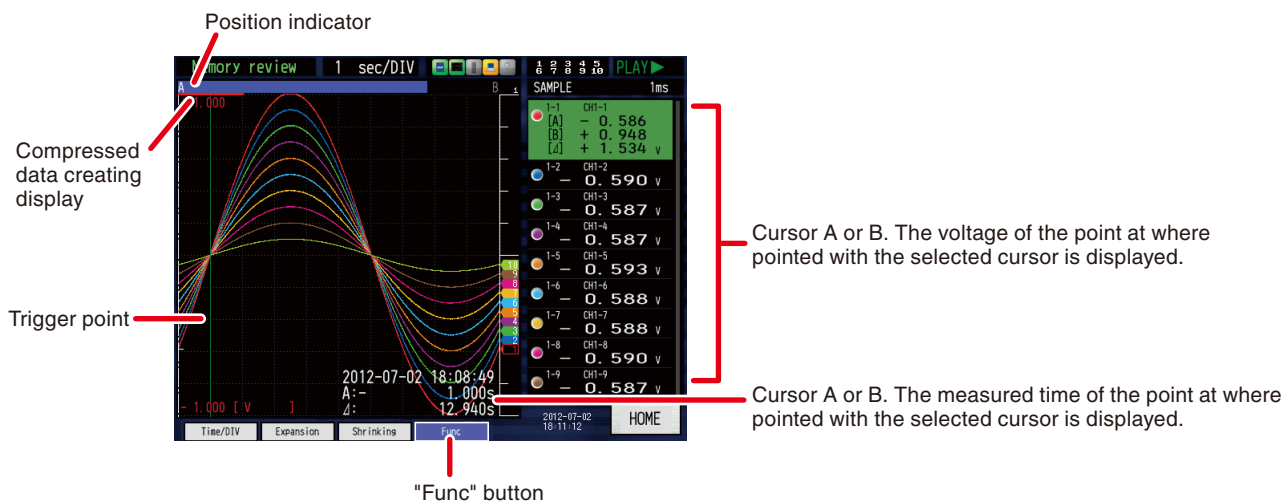

Touch the "Func" button to display the function menu and access multiple functions. Also, the touched line is displayed at the bottom of the screen.

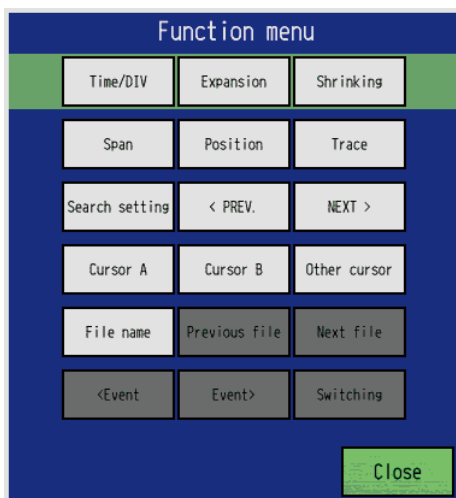

Item Select	Description
Time/DIV	Change the time axis scale of the waveform. (See page 3-135)
Expansion	Expand the time axis scale of the waveform. (See page 3-135)
Shrinking	Shrink the time axis scale of the waveform. (See page 3-135)
Span	Change the amplitude of the waveform. (See page 3-135)
Position	Change the display position of the waveform. (See page 3-135)
Trace	Set the waveform display to On / Off. (See page 3-135)
Search setting	By setting conditions, you can search for data that is satisfied the conditions. (See page 3-161).
< PREV.	The cursor is moved to the position satisfying the search condition before the current cursor position.
NEXT >	The cursor is moved to the position satisfying the search condition after the current cursor position.
Cursor A	Switch to cursor A.
Cursor B	Switch to cursor B.
Other cursor	Call the other cursor.

Item Select	Description
File name	Display the file name.
Previous file.	When replaying consecutive files captured with repeat capturing, you can switch to the previous file.
Next file	When replaying consecutive files captured with repeat capturing, you can switch to the next file.

Possible main actions during replay

Setting the measurement condition	Measurement conditions can be set.
Waveform operations	The waveform positions can be moved or zoomed in or out (See page 3-135).
Moving the cursor	The cursor can be moved to a designated place (See page 3-159). When the left edge of the position indicator touched, "Move to first", and when the right edge of the position indicator touched, "Move to last".
Search	By setting the requirements, data passing the requirements can be searched (See page 3-161).
File operations	File operations can be done (See page 3-32).
Save Data	The entire data or data with certain set parameters can be saved (See page 3-153).
Replay data	Data recorded can be replayed (See page 3-152).
Changing the timescale	The timescale on the time axis can be changed (See page 3-135).
Copy Screen (Screenshot)	The current waveform displayed as a BMP or PNG format can be saved (See page 3-158).
Statistical Calculation	Average value, peak value, maximum value, and minimum value for the data during replaying are displayed (see page 3-164).

File replay with dual sampling

When replaying the dual sampling file (DSA file) recorded when dual sampling is enabled, you can replay Current recording file (low-speed recording) and Event recording file (high-speed recording) in association with each other. Switching between current file replay and event file replay is performed using "To Event", "To Current" function button.

* It is also possible to replay low-speed captured file and high-speed captured file individually.

When replaying the data of Current (low-speed) capturing side

Position indicator This indicates the location of the event data in the current data as a whole.

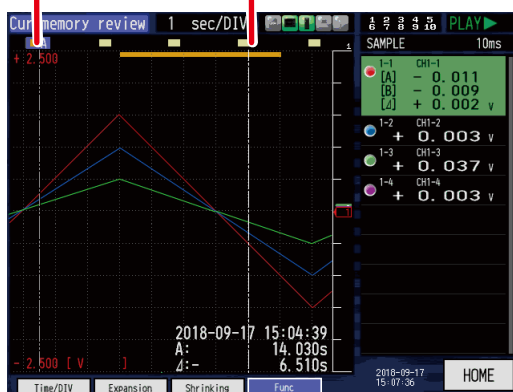

"Func" button

Touch the "Func" button to display the function menu and access multiple functions. Also, the touched line is displayed at the bottom of the screen.

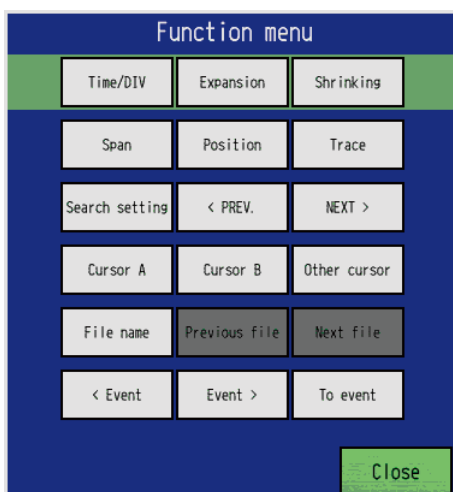

Item Select	Description
Time/DIV	Change the time axis scale of the waveform. (See page 3-135)
Expansion	Expand the time axis scale of the waveform. (See page 3-135)
Shrinking	Shrink the time axis scale of the waveform. (See page 3-135)
Span	Change the amplitude of the waveform. (See page 3-135)
Position	Change the display position of the waveform. (See page 3-135)
Trace	Set the waveform display to On / Off. (See page 3-135)
Search setting	By setting conditions, you can search for data that is satisfied the conditions. (See page 3-135).
< PREV.	The cursor is moved to the position satisfying the search condition before the current cursor position.
NEXT >	The cursor is moved to the position satisfying the search condition after the current cursor position.
Cursor A	Switch to cursor A.
Cursor B	Switch to cursor B.
Other cursor	Call the other cursor.
File name	Display the file name.
< Event	It is moved to the event data that exists before the data currently displayed.
Event >	It is moved to the event data that exists after the data currently displayed.
To event	It is switched to current data file replay.

When replaying the data of Event (high-speed) capturing side

Position indicator

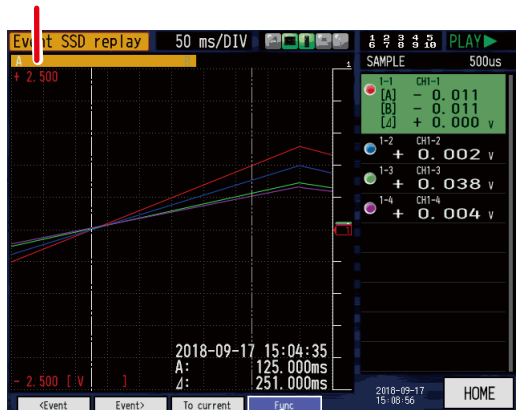

"Func" button

Touch the "Func" button to display the function menu and access multiple functions. Also, the touched line is displayed at the bottom of the screen.

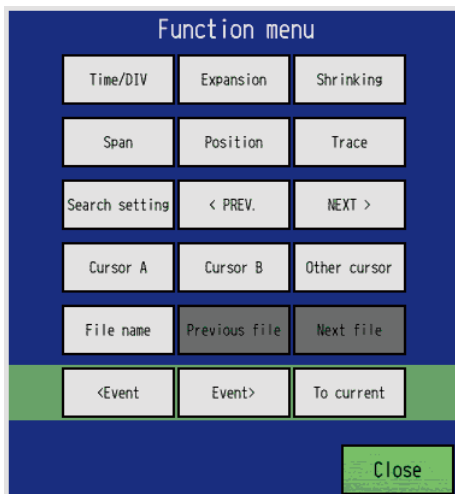

Item Select	Description
< Event	It is moved to the event data that exists before the data currently displayed.
Event >	It is moved to the event data that exists after the data currently displayed.
To curent	It is switched to current data file replay.

Main possible actions

Setting the measurement condition	Measurement conditions can be set.
Waveform operations	The waveform positions can be moved or zoomed in or out (See page 3-135).
Moving the cursor	The cursor can be moved to a designated place (See page 3-137). When the left edge of the position indicator touched, "Move to first", and when the right edge of the position indicator touched, "Move to last".
Search	By setting the requirements, data passing the requirements can be searched (See page 3-161).
File operations	File operations can be done (See page 3-32).
Save Data	The entire data or data with certain set parameters can be saved (See page 3-153).
Replay data	Data recorded can be replayed (See page 3-152).
Changing the timescale	The timescale on the time axis can be changed (See page 3-135).
Copy Screen (Screenshot)	The current waveform displayed as a BMP or PNG format can be saved (See page 3-158).
Statistical Calculation	Average value, peak value, maximum value, and minimum value for the data during replaying are displayed (see page 3-164).

CHECKPOINT

- When replaying with the double-screen, the historical data is displayed with thinning temporarily. In this case, a red line is displayed while creating compressed data. (As soon as the compressed data is created, it is displayed.)
- When the sampling interval used in recording with the built-in RAM is 500 μ s or less, the recording stops, and then it is automatically replayed.

3.6 Explanation of the Settings Menu

Pressing the "Home" button on the screen or the "HOME" key displays the home screen, By pressing each icon button, each settings menu can be selected.

(1) Record settings

Changes settings mainly related to recording.

("Home" → "Machine" → "Data" → "Capture")

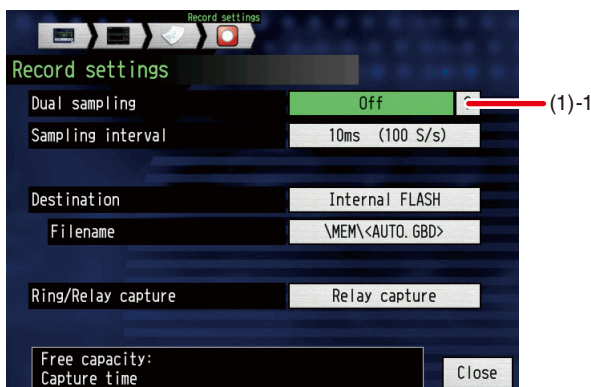

(1)-1 Dual sampling

Set dual sampling function to On / Off.

To capture at one sampling interval, set it to Off.

For low-speed capturing and high-speed capturing at two sampling intervals for one input signal, set it to On.

Dual sampling

When using dual sampling, you can perform Current (low-speed) capturing and Event (high-speed) capturing at the same time with two samplings.

It is a function for efficient capturing such as performing high-speed event capturing at pinpoint while low-speed capturing for a long time in the current capturing.

Setting conditions

Item select	Current (low-speed) capturing	Event (high-speed) capturing
Sampling interval	1, 2, 5, 10, 20, 50, 100, 125, 200, 250, 500 ms; 1, 2, 5, 10, 20, 30 s; 1, 2, 5, 10, 20, 30 min; 1 h	1, 2, 5, 10, 20, 50, 100, 200, 500 us
Capturing destination	Built-in flash memory / SD card	Built-in RAM: Capturing available only once Extended SSD unit: Multiple capturings possible (* Up to 100 files)
Timer trigger	Time: 00:00 to 23:59	Trigger: Off, Level, Alarm, External input, Specified time, Specified day of the week, Fixed time

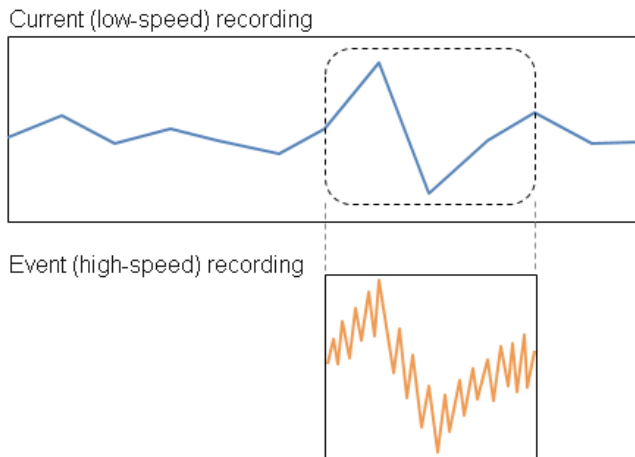

Example of capturing setting

- 1) Current (low-speed) capturing: In case of 1 ms sample interval, built-in flash capturing; Event (high-speed) capturing: 10 μ s, built-in RAM capturing.

Captured data

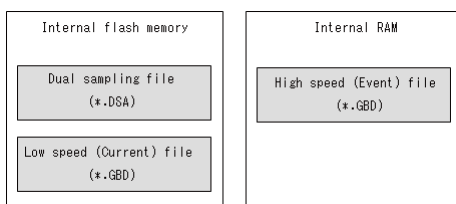

- 2) Current (low-speed) capturing: In case of 10 ms sample interval, SD card capturing; Event (high-speed) capturing, 10 μ s, extended SSD capturing.

Captured data

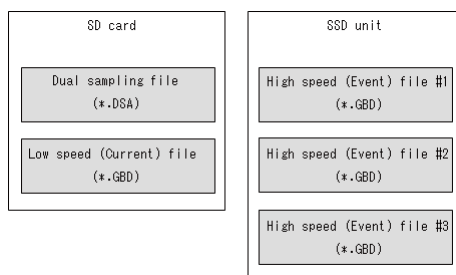

CHECKPOINT

- For Current (low-speed) capturing and Event (high-speed) capturing, the data is saved in GBD file type.
- External sampling cannot be used.
- Ring / Relay capturing cannot be used.
- Backup function cannot be used.
- Double-screen replay cannot be used during capturing.
- XY and FFT functions cannot be used.
- Synchronization control with multiple GL7000s cannot be used.
- When Event (high-speed) capturing destination is SSD Module, it takes a few seconds for Event capturing.
- SD card during capturing cannot be replaced.
- When using the pulse amplifier with the Rotation (rpm) / instantaneous value, the pulse value of the current capturing is calculated by calculating the measured value of the event capturing for the current sampling time. Therefore, the captured data on the current side contains errors.
- When low-speed units (such as GL7-M) only are connected, the dual sampling function is not enabled.
- The sampling timing of Current (low-speed) and Event (high-speed) are different, so recorded data may be different.

When dual sampling is set to Off

<When capturing destination is internal RAM>

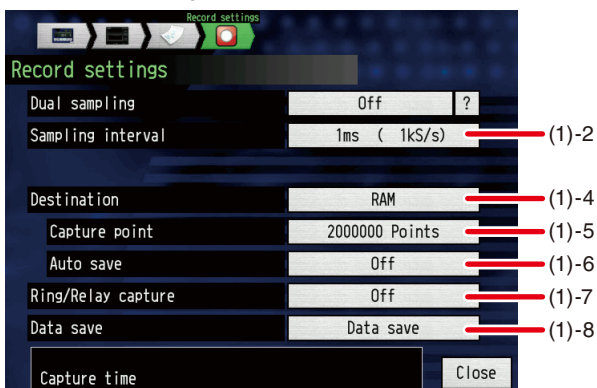

<When capturing destination is other than built-in RAM>

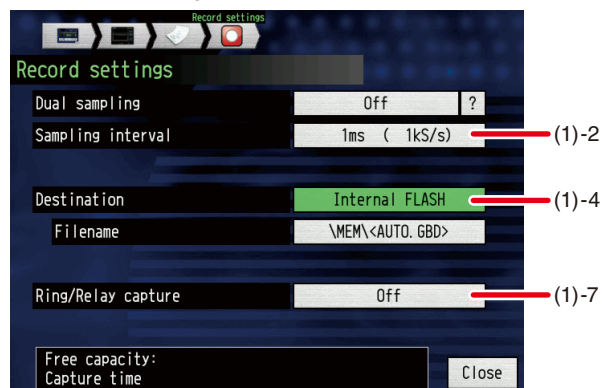

<When sampling interval is from external device>



Item select		Examples of item	
(1)-2	Sampling interval	1/2/5/10/20/50/100/200/500us, 1/2/5/10/20/50/100/125/200/250/500ms, 1/2/5/10/20/30s, 1/2/5/10/20/30min, 1h, External	
(1)-3	[External] AC Line filter	Off, On	
(1)-4	Destination	RAM, Internal FLASH, SD Card, SSD Module	
(1)-5	[RAM] Capture point	1 to 2,000,000 (Numerical entry)	
(1)-6	Auto save	Off, On	
(1)-7	Ring/Relay capture	Off, Ring capture, Relay capture	
	Data points	1 to 2,000,000 (Numerical entry)	
	Relay mode	Time / Capacity	
	Relay capacity / Relay time	Relay capacity: 100 to 4000MB Relay time: 00:01 to 24:00	
(1)-8	[Internal FLASH]	Data save	* Please refer to the file name of the saved data.
	[SD Card]		
	[SSD Module]		

When dual sampling is set to On

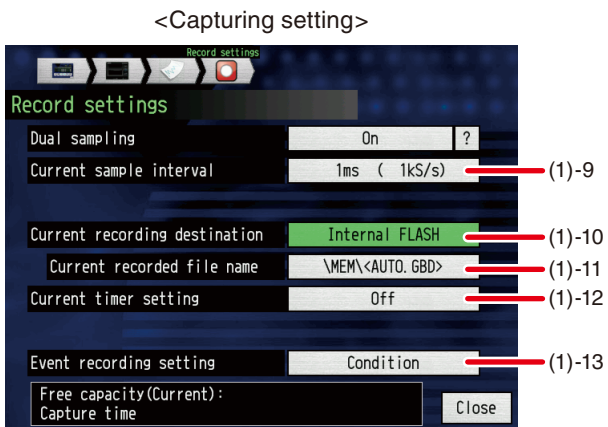

	Item select	Examples of item
(1)-9	Current sample interval	1, 2, 5, 10, 20, 50, 100, 125, 200, 250, 500 ms; 1, 2, 5, 10, 20, 30 s; 1, 2, 5, 10, 20, 30 min; 1 h
(1)-10	Current capturing destination	Built-in flash memory, SD card
(1)-11	Current captured file name	* Refer to the section of current capturing file name.
(1)-12	Current timer setting	* Refer to the section of current timer setting.
(1)-13	Event capturing setting	* Refer to the section of event capturing setting.

(1)-2 Sample interval

Sets the data recording interval.

The fastest sample interval that can be set is limited by the following items. If a sample interval that cannot be recorded is set, the color changes and this mark is displayed. (▲ 1us)

If the sample interval displays this mark, please change the recording destination when going to record.

<Things affecting sampling rate>

- Recording destination
- Connected amplifier types
- Number of connected amplifiers (When the recording destination is the SSD)
- File format

Recording destination, file format, and sample interval

Recording destination		File format	Sample interval*1
RAM		—	1us to 1h, External
Internal FLASH		GBD (Binary)	1ms to 1h, External
		CSV (Text)	10ms to 1h, External
SD Card		GBD (Binary)	1ms to 1h, External
		CSV (Text)	10ms to 1h, External
SSD Module*4	1 to 2 modules	GBD (Binary)	1us to 1h, External *2
	3 to 4 modules		2us to 1h, External *3
	5 to 10 modules		5us to 1h, External
	1 to 10 modules	CSV (Text)	10ms to 1h, External

*1: The fastest sample interval changes depending on the connected amplifier module type. The possible recording sample interval varies for each connected Amplifier Module. When combining different types of Amplifier modules, the sample interval of the fastest Amplifier Module can be set, but the slow Amplifier module continues with the same data until data changed at the fastest sampling interval it can manage.

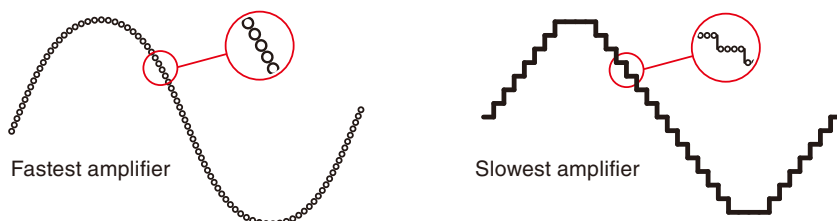

*2: When a Logic/Pulse module is connected and a pulse selected, 8ch (CH1-CH8) can be recorded at 1 μs or 2 μs. However, the maximum sampling rate of the pulse is 100 μs, so the data is updated only every 100 μs.)

*3: When a Logic/Pulse module is connected and a pulse selected, 16ch can be recorded over 5 μs. When two modules are connected, and a pulse selected, each module can record data to 8ch (CH1-CH8). (However, the maximum sampling rate of the pulse is 100 μs, so the data is updated only every 100 μs.)

< Ex. 1> Sampling 1 μs



The pulses of CH1 to CH8 are recorded.

< Ex. 2> Sampling 2 μs

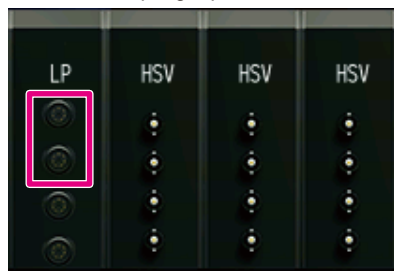

The pulses of CH1 to CH8 are recorded.

< Ex. 3> Sampling 5 μs

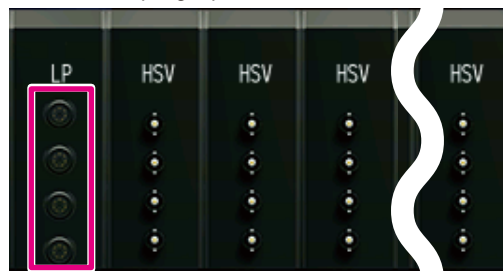

The pulses of CH1 to CH16 are recorded.

External Sampling

When the external sample interval is set, the data is captured and retained once with the internal sample interval.

This retained data is updated with the external sample interval.

The data to be recorded is written in the recording destination each time the external sampling pulse is received (See the figure below).

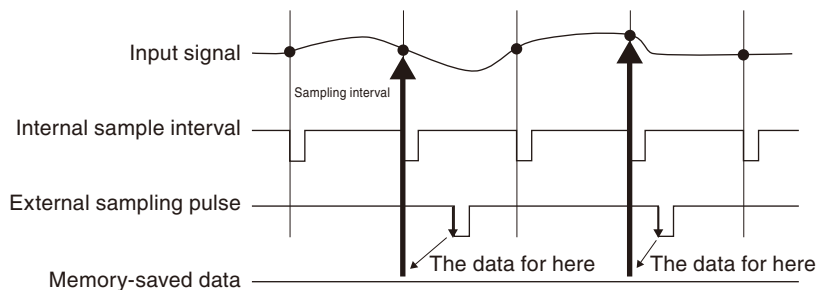

CHECKPOINT

If the external sampling pulse has entered two or more times faster than the internal sample interval, the second and subsequent times are ignored. Set the external sampling to longer interval than the internal sample interval.

The internal sample interval is as follows.

Recording destination	High Speed Voltage/ High Voltage module	Voltage module	Voltage/Temperature module	Logic/Pulse module
RAM	1 μ s	1 ms	See "(1)-3 AC line filter".	Logic 1 μ s/Pulse 100 μ s
Internal FLASH	1 ms	1 ms	See "(1)-3 AC line filter"	1 ms.
SD Card	1 ms	1 ms	See "(1)-3 AC line filter"	1 ms
SSD Module	1 ms	1 ms	See "(1)-3 AC line filter"	1 ms

(1)-3 AC Line filter

This is set for an option module GL7-M only.

Set the AC line filter to On/Off when the sampling interval is set to external.

When set to On, the digital filter of the Voltage/Temperature amplifier is enabled. When measuring a signal with lots of noise and using external sampling, please set the AC Line filter to On.

The fastest interval is 1 second.

OFF: The Internal sample interval is 10 ms.

ON : The Internal sample interval is 1 s.

For the internal sample (interval), see the descriptions of the "External Sampling" above.

(1)-4 Destination

Selects the recording destination. Each recording destination has its advantages.

RAM : Recording can be done at the fastest sample interval. The maximum number of recording points is 2,000,000.

The fastest sample interval changes for the types of modules, but even if the number of modules is increased, the maximum number of recording points does not change. Data is deleted if the power is turned off or the next recording is performed. Recording in CSV format is not possible.

Internal FLASH : The sample interval starts at 1ms (10ms in the case of CSV format).

It remains even if the power is turned off. Direct access from a PC is possible if the built-in flash memory is opened in USB Drive Mode.

- SD Card : Recording can be done when an SD card is inserted into the SD slot. The sample interval starts at 1ms (10ms in the case of CSV format). Data remains even if the power is turned off. By taking out the SD card, it can be directly seen on a PC.
- SSD Module : This is an optional module. It's suitable for high speed, large capacity recording. The fastest sample interval changes depending on the number of connected modules (refer to "(1)-2 Sample interval" on page 3-62). In the case of CSV format it starts from 10ms. Data remains even if the power is turned off.

CHECKPOINT

- When the built-in RAM is selected as recording destination, by setting the auto-save function to ON (refer to (1)-6 Auto-save on page 3-65), recorded data can be saved on nonvolatile memory (built-in flash memory, SD card or expanded SSD).
- As the auto-save takes some time, even after the recording is finished, the writing to the built-in flash memory, SD card or expanded SSD may not be finished. Please do not turn off the power until it's finished.

(1)-5 Capture point

Sets the number of data points when recording to the built-in RAM. This can only be set if built-in RAM was selected to be recorded to.

Enter a number. (For details, see "(1) Numerical entry" on page 3-28.)
 ("Home" → "Machine" → "Data" → "Capture" → "Capture point")

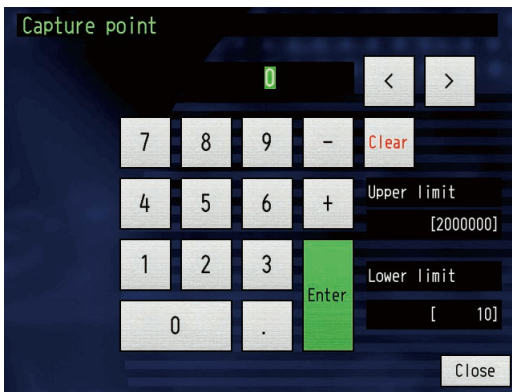

The possible recording time depends on the settings of the sampling interval and the number of recording points. The recording time is displayed in the part A in the figure below.

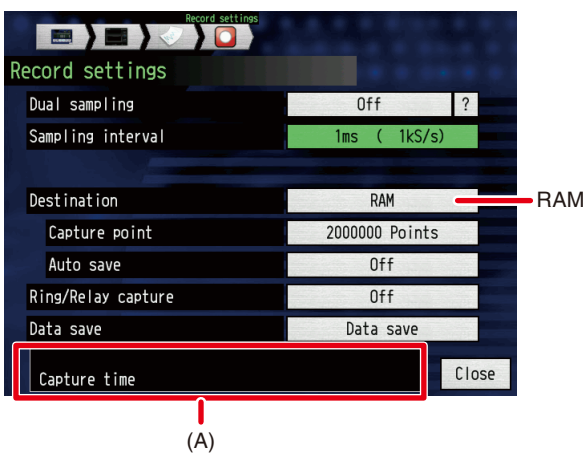

(1)-6 Auto save

Sets the auto-saved function for the built-in RAM. This can only be set when RAM is selected to be recorded to. ("Home" → "Machine" → "Data" → "Capture" → "Auto save")



Item select		Examples of item
(1)	Auto save	Off, On
(2)	File name	Recording destination folder name or file name
(3)	Name type	Auto, User, Serial number

(1) Auto save

Item select	Examples of item
Off	Auto save is not activated. Data is deleted if the power is turned off or the next recording is performed. When wanting to save recorded data, please save data after replay (refer to "(18) Data Save" on page 3-153).
On	Auto save is done. Data recorded on the built-in RAM is saved on the built-in flash memory, SD card or the expanded SSD. HINT When speeding up the sample interval or increasing the number of recorded data, even if recording to the built-in RAM has been finished, auto-save may not be finished. At such a time, it is not possible to perform the next recording using the Start/Stop key until the auto-save has finished.

(2) File name

Specifies the recording destination folder and file name. Refer to "(3) File operations" on page 3-32 on how to set a file.

(3) Naming type

Sets how data files are named.

Auto : Files are automatically named.
 <Ex>:20120101-123456.GBD

The numeric part The day the file was created
 * E.g. 2012-01-01, 12:34:56

GBD..... Data format, GBD (Binary data), CSV (Text format)

User : Data is recorded to a user-input file name.

Serial number: A consecutive number is attached to the optionally input file name to create the file name.

<Ex>: When the file name is "TEST"

First: TEST_SER1.GBD, Second: TEST_SER2.GBD, Third: TEST_SER1.GBD

* If a file with the same name already exists, to avoid overwriting _CP* is attached to the end of the file name where the * represents a number.

<Ex.>: TEST_CP1.GBD

(1)-7 Ring/Relay capture

("Home" → "Machine" → "Data" → "Capture" → "Ring/Relay capture settings")

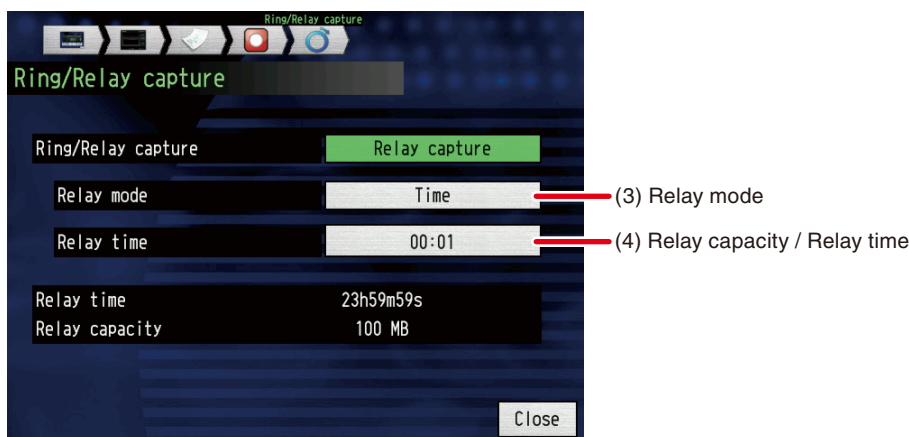
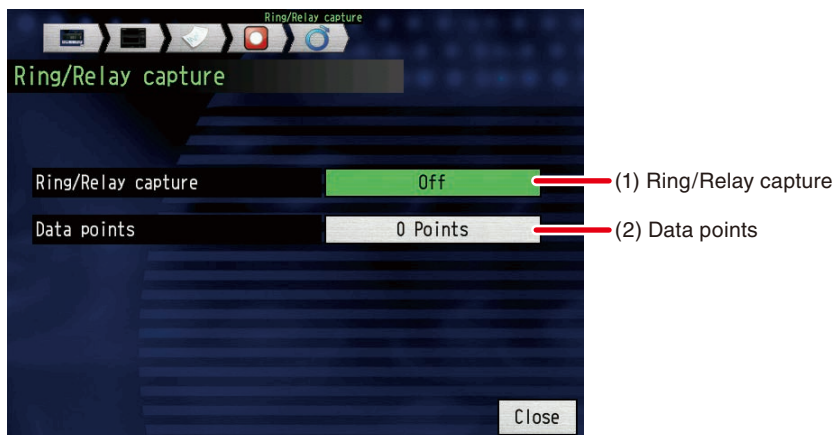

Item select		Examples of item
(1)	Ring/Relay capture	Off, Ring capture, Relay capture
(2)	Data points	1,000 to 2,000,000
(3)	Relay mode	Time / Capacity
(4)	Relay capacity / Relay time	Relay time: 00:01 to 24:00 Relay capacity: 100 to 4000MB

(1) Ring/Relay capture

Set the capture function.

Off : The capture function is not disabled.

Ring capture : The Ring capture is enabled. If the recording points exceed the number of recording points that has been set, the capture is performed while erasing the old data. When the Ring capture is selected, "(2) Data points" should be set.

For details on the Ring capture, see the "Ring capture operation (next page)"

Relay capture : Data is continuously captured in files separated by specified time or capacity without missing data.

The maximum capacity of one file is 4GB.

Sampling rate that can be set in the Relay capture is as follows;

<Recording destination: Internal FLASH/SD card>

1 to 10 Modules : 10ms to 1h, External

<Recording destination: SSD Module>

1 to 2 Modules (The pulse is up to 8 channels.) : 20μs to 1h, External

3 to 4 Modules (The pulse is up to 16 channels.) : 50μs to 1h, External

5 to 10 Modules : 100μs to 1h, External

* When recording in CSV format, the sampling rate is 20ms to 1h, External.

- * "Contents set by file naming" _RELAY*.GBD (CSV) is assigned as a file name.
The * is a sequence number starting from 1.
For details on file naming, see the "(1)-8 Data save".

(2) Data points

When the ring function is On, the ring point of 1 file is specified.

- Ring capture actions (When the recording destination is the built-in RAM)

If the recording destination is the built-in RAM, the memory is connected in a ring form, and when it exceeds the specified number of the data points, data is deleted starting with the oldest data.

When the main module stops, the data on the number of data set in Number of recording points remain.

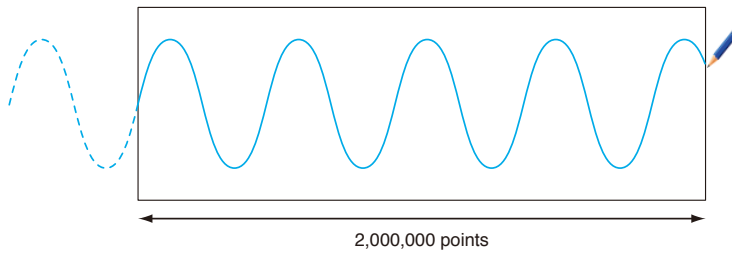

⚠ CAUTION

- When the CSV Format Recording and the backup function enabled, the relay recording is not able to perform.
 - When backup setting is enabled, the data may not be recorded continuously because relay file is switched after backup operation. In this case, disable the backup setting and start capturing.
 - SD card cannot be replaced during relay capturing.
 - When specified in the relay capacity setting, the data size actually captured may be smaller than the capacity according to the number of capturing channels.
 - Double-screen replay cannot be selected during relay capturing.
-

- Ring capture actions (When the recording destination is something other than built-in RAM)
If the recording destination is something other than the built-in RAM, ring capture action is done in the following way.

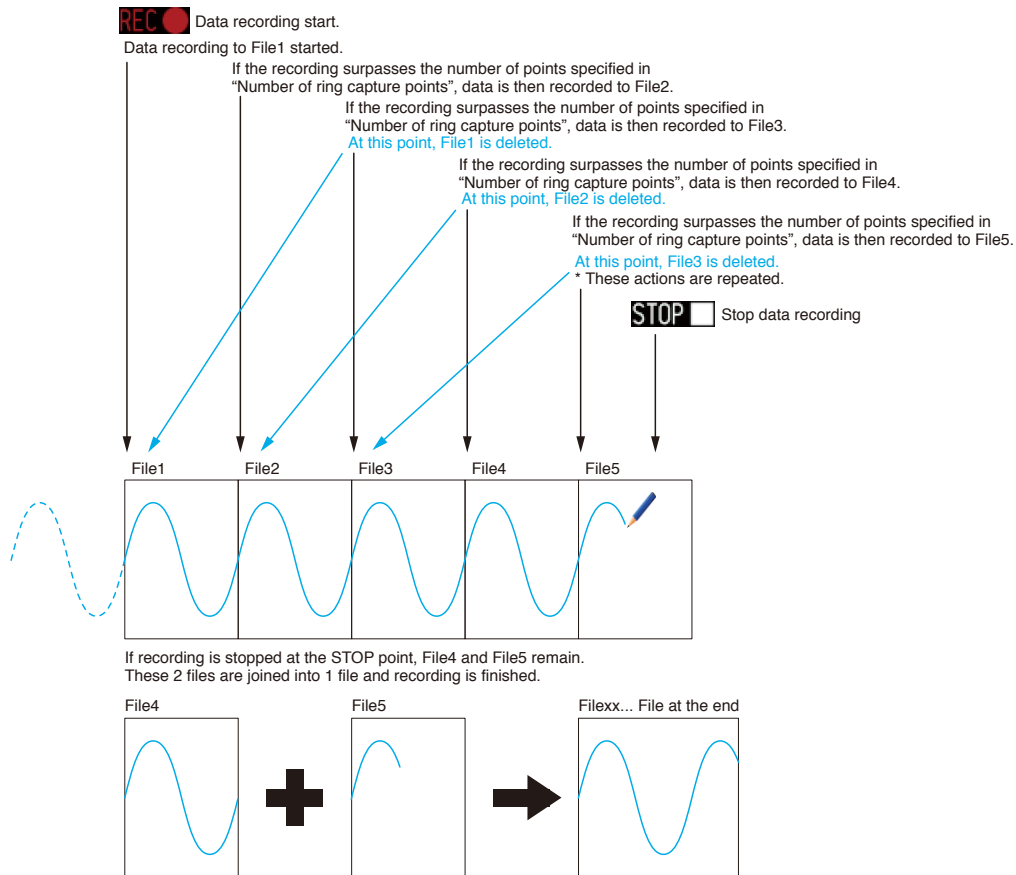

CHECKPOINT

- Up to 2 times the number of ring capture points are possible as files at max.
- The upper limit value of the number of recording points is 1/3 of the free capacity..

(1)-8 Data save

Sets the file name and folder name for the recording destination or the auto save destination.
("Home" → "Machine" → "Data" → "Capture" → "Data save")

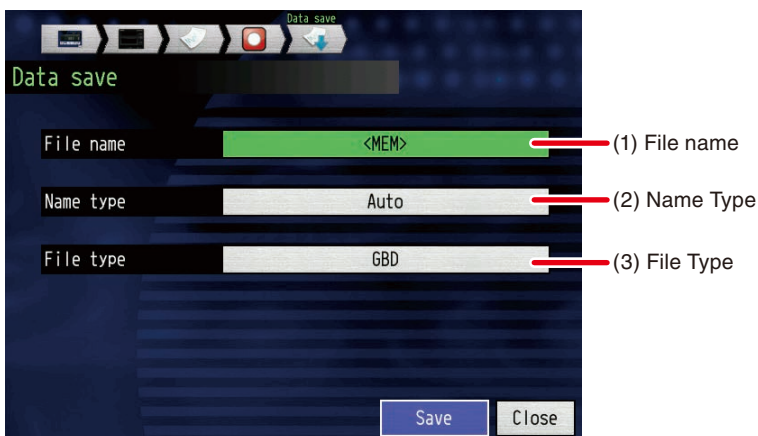

Item select		Examples of item
(1)	File name	File name or folder name of recording destination.
(2)	Name Type	Auto, User, Serial number
(3)	File Type	GBD (Binary), CSV (Text)

(1) File name

Specifies the folder and file name of the recording destination. Refer to "(3) File operations" on page 3-28 on how to set a file.

(2) Name Type

Sets how the data file name is attached.

Auto : Files are automatically named.

<Ex.>: 20120101-123456.GB
 The numeric par..... The day the file was created
 * E.g. 2012-01-01, 12:34:56
 GBD Data format
 GBD (Binary data), CSV (Text format)

User : Data is recorded to a user-input file name.

Serial number: A consecutive number is attached to the user-input file name to create the file name.

<Ex.>: When the file name is "TEST"
 First: TEST_SER1.GBD, Second: TEST_SER2.GBD, Third: TEST_SER3.GBD

* If a file with the same name already exists, to avoid overwriting _CP* is attached to the end of the file name where the * represents a number.

<Ex.>: TEST_CP1.GBD

(3) File Type

Sets the data file format.

GBD: A data file is created by our company's original binary format.

CSV : A data file is created with the text format.

* It cannot be replayed on the GL7000.

CAUTION

Please create a folder and save the file in it. Depending on file system limitations, and regardless of the remaining free memory, saving to the root directory may not be possible.

CHECKPOINT

By changing the sample interval, recording destination or number of measured channels (number off channels where input is not Off), the free capacity and possible recording time displayed on the screen will change. After checking, if the measurement time exceeds the possible recording time, please take one of the following steps:

- Change the sample interval.
- Copy the files at the recording destination to a PC and then delete them.
- Switch the recording destination to a high free capacity memory option. (SD card, SSD, etc.)

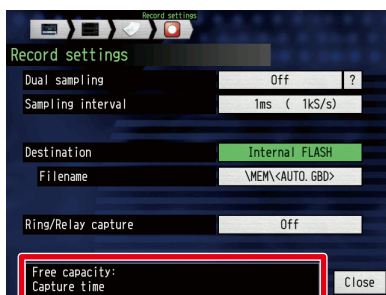

Free Memory..... Displays the amount space available to be recorded on.

Possible recording time... Displays the possible recording time.

* The possible recording time is estimated up to maximum 4GB.

- If the possible recording time exceeds 366 days, "Over 366 days" is displayed.

(1)-9 Current sample interval

Set the sampling interval on the low-speed side of the dual sampling function.

(1)-10 Current capturing destination

Set the capturing destination on the low-speed side of the dual sampling function. Built-in flash memory or SD card can be selected.

When capturing, a dual sampling file is generated together with the current captured file.

The dual sampling file is a file that manages the Current (low-speed) captured file and the Event (high-speed) captured file. When replaying the data captured with the dual sampling function, select the dual sampling file.

The dual sampling file has the extension *.DSA".

CHECKPOINT

- When the Current (low-speed) capturing destination become full, Event (high-speed) capturing also stops.
- When replaying Current (low-speed) captured file or Event (high-speed) captured file directly, it is replayed as normal file.
- When the capacity of the capturing destination is full, Event (high-speed) capturing cannot be started. This is the same when setting the timer.

(1)-11 Current capturing file name

Set the captured file name on the low-speed side of the dual sampling function.

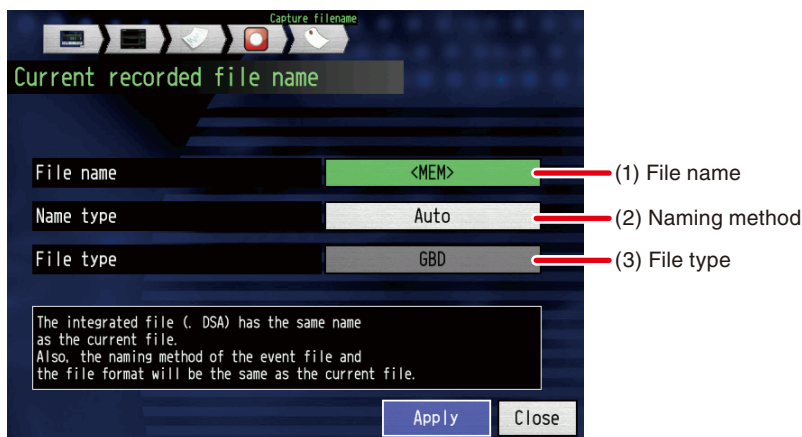

Item select		Examples of item
(1)	File name	Capturing destination folder name or file name
(2)	Naming method	Auto, Arbitrary, Sequential number
(3)	File type	GBD fixed

(1) File name
Specifies the folder and file name of the recording destination. Refer to "(3) File operations" on page 3-32 on how to set a file.

(2) Name Type
Sets how the data file name is attached.
The naming method "Auto" at dual sampling is different from normal capturing. Naming method other than Auto is the same as normal capturing.
<Ex.>: When capturing starts at 12:34:56 on October 1, 2018
Auto folder name

Normal capturing: 20181001
Dual sampling capturing: 20181001-123456

Auto file name

Normal capturing: 20181001-123456.GBD

Dual sampling capturing: 20181001-123456.GBD

User : Data is recorded to a user-input file name.

Serial number: A consecutive number is attached to the user-input file name to create the file name.

<Ex.>: When the file name is "TEST"

First: TEST_SER1.GBD, Second: TEST_SER2.GBD, Third: TEST_SER3.GBD

* If a file with the same name already exists, to avoid overwriting _CP* is attached to the end of the file name where the * represents a number.

<Ex.>: TEST_CP1.GBD

(3) File Type

Sets the data file format.

GBD: A data file is created by our company's original binary format.

 CAUTION

Please create a folder and save the file in it. Depending on file system limitations, and regardless of the remaining free memory, saving to the root directory may not be possible.

(1)-12 Current timer setting

Set the capturing timer on the low-speed side of the dual sampling function.



Item select		Examples of item
(1)	Start timer	Off / On
(2)	Time setting	00:00 - 23:59
(3)	Stop timer	Off / On
(4)	Time setting	00:00 - 23:59
(5)	Repeat capturing	Off / On

(1) Start timer

Set the start timer for Current (low-speed) capturing.

Off : Capturing starts unconditionally when the START/STOP key is pressed.

On : Capturing starts when the specified time comes.

(2) Time setting

Set the start time for Current (low-speed) capturing.

(3) Stop timer

Set the stop timer for Current (low-speed) capturing.

Off : Capturing stops unconditionally when the START/STOP key is pressed.

On : Capturing stops when the specified time comes.

(4) Time setting

Set the stop time for Current (low-speed) capturing.

Leave at least 1 minute interval between start time and stop time.

(5) Repeat capturing

Set repeat function to perform repeat capturing. It can be set when the stop timer is enabled.

(1)-13 Event capturing

Set capturing the timer on the high-speed side of the dual sampling function.

<When the event capturing destination is internal RAM>

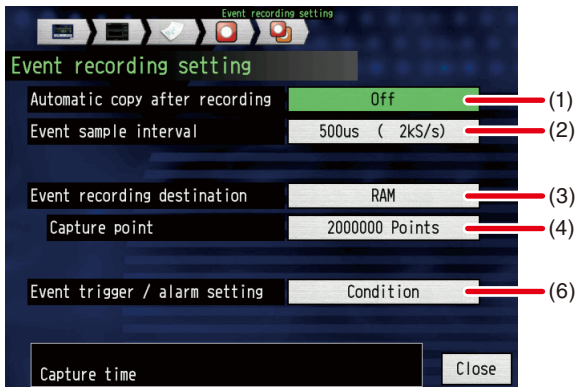

<When the event capturing destination is SSD Module>



Item select		Examples of item
(1)	Auto copy after capturing	Off, Copy to current side, Copy to event side
(2)	Event sample interval	1, 2, 5, 10, 20, 50, 100, 200, 500 us
(3)	Event capturing destination	Built-in RAM, SSD Module
(4)	Capture point	10 to 2,000,000 (Numerical entry)
(5)	Event capturing folder name	Select folder
(6)	Event trigger / Alarm setting	(5) Refer to trigger / alarm setting

(1) Auto copy after capturing

When current timer repeat capturing is enabled, repeat capturing is performed after auto copy is finished. So it may not be possible to start according to the current start time of next capturing when it takes time to perform auto copy.

Off : Auto copy is not available.

Copy to

current side : Event (high-speed) file is copied to the Current (low-speed) capturing destination. It is enabled when event capturing is set to internal RAM.

Copy to event

side : Current (low-speed) capturing file and dual sampling file are copied to Event (high-speed) capturing destination. It is enabled when using SSD Module.

CHECKPOINT

- Copy may take time depending on the captured file size.
- When current timer repeat capturing is enabled, the next repeat capturing is performed after auto copy is finished. So it may not be possible to start according to the start time of current timer when it takes time to perform auto copy.

(2) Event sample interval

Set the sampling interval on the Event (high-speed) side of the dual sampling.

(3) Event capturing destination

Set the capturing destination on high speed (Event) side of dual sampling.

Built-in RAM : Up to 2,000,000 points can be captured once in one dual sampling capturing.

The pre-trigger function can be used for internal RAM only.

Since the data is lost when you turn off the power supply,
use auto copy "Copy to current side" to save the data.

SSD Module : It is possible to perform multiple capturings in one dual sampling capturing.

One capturing can record up to 4GB.

_EV *** (***) is a sequential number.) is appended to the end of the file name.

(Example: AAAA_EV001.GBD)

(4) Capture point

When Event (high-speed) capturing destination is the built-in RAM, set the capture point to be captured in built-in RAM. It is from 10 to 2,000,000 points.

(5) Event capturing folder name

When capturing destination on Event (high-speed) side is SSD Module, set the saving folder name.

Captured file name and naming method are the same setting as Current (low-speed) capturing side.

(6) Event trigger / Alarm setting

Perform trigger and alarm settings for capturing on Event (high-speed) side. The setting contents are the same as the normal capturing. Refer to (5) Trigger / Alarm setting.

(2) Marker settings

Sets the marker to display on the waveform.

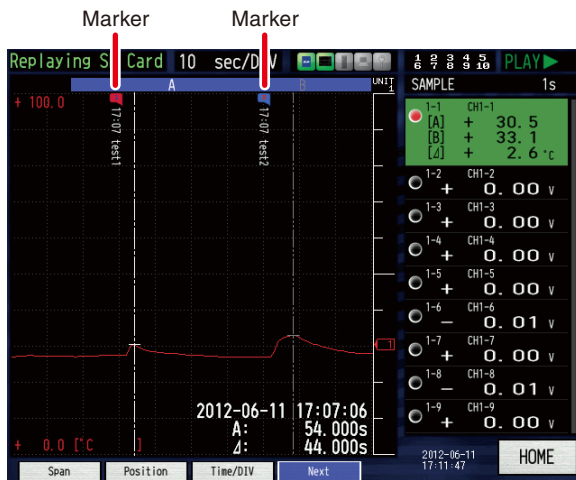

("Home" → "Machine" → "Data" → "Marker")

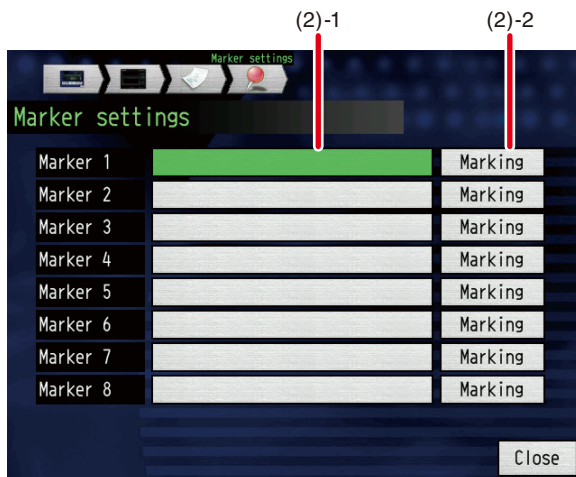

Item select		Examples of item
(2)-1	Marker	Text entry (Maximum 30 characters)
(2)-2	Marking	Outputs the marker.

(2)-1 Marker

Allows the user to set the characters that are displayed. Up to 8 settings. The characters are restricted to half-width alphanumeric.

(2)-2 Marking

The characters set in a marker can be displayed on the screen.

Outputs the marker.

The outputted marker is displayed on screen and recorded with the data.

CHECKPOINT

- The markers displayed are also saved in the recorded data.
- It is impossible to newly mark the replaying data.
- Although you can change the marker character setting during recording, the characters set when the recording is stopped or the SD card is replaced are displayed during replaying.
- A marker can be inserted in any place, but since the marker information is recorded on the data file, it affects file size.

(3) Backup settings

The GL7000 has a function that periodically backs up recording data (refer to the chart below). Here, the user can set the conditions for data backup.

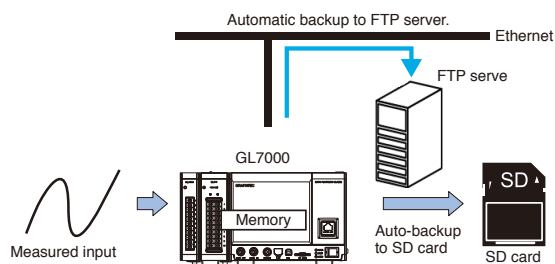

("Home" → "Machine" → "Data" → "Backup settings")



Item select	Examples of item
(3)-1 Backup intervals	Off, 1, 2, 6, 12, 24 hour(s)
(3)-2 Backup destination	SD card, SSD, FTP (The recording data can be backed up to an external storage device.)
(3)-3 Save folder	Text entry

CHECKPOINT

- You can not specify the same location as the backup destination and recording destination.
- The recording data can be backed up to an external storage device.
- When ring capturing, dual sampling, and external sampling function are set to On, the backup function cannot be used.
- When relay capturing is set to On, the data may not be captured continuously because the relay file is switched after the backup operation is completed.
- When the backup is performing for the CSV Format, the SD-Memory Card exchange and the relay recording are not able to perform.
- When saving to an FTP server, backup may fail depending on the communication environment and transfer speed.

(3)-1 Backup intervals

Set the backup interval for recording data.

(3)-2 Backup destination

Set the destination for data backup of the recording file. Depending on the recording destination, the selectable backup destinations changes.

Recording destination	Backup destination		
	SD card	SSD	FTP
Built-in flash memory	OK	OK	OK
SD card	NG	OK	OK
SSD	OK	NG	OK

(3)-3 Save folder

Set the name of the folder to which the backup file will be saved. This becomes the backup destination folder.

(4) Output settings

This is used to output the analog voltage to the equipment to be received.

("Home" → "GL7000 setting" → "Data settings" → "Output settings")

<Output settings>

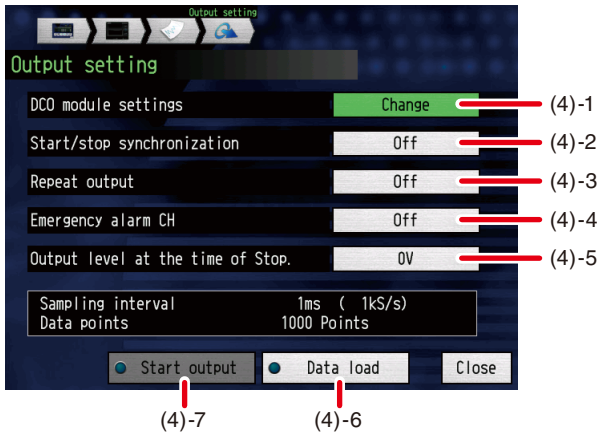

<Output settings → DCO module settings>

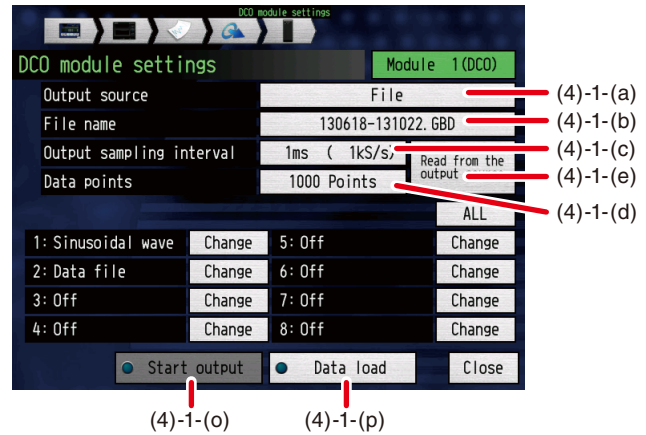

<When using Sine wave, Triangle wave, Ramp wave>

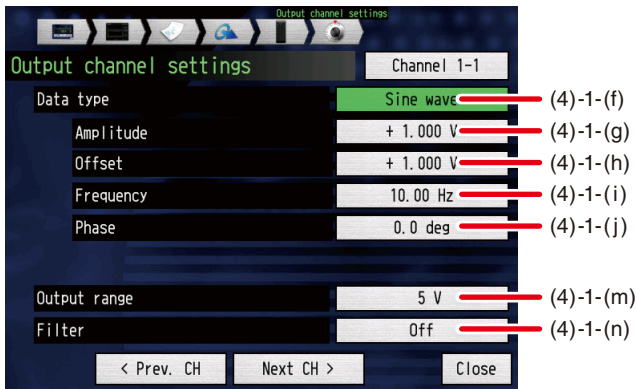

<When using Pulse wave>

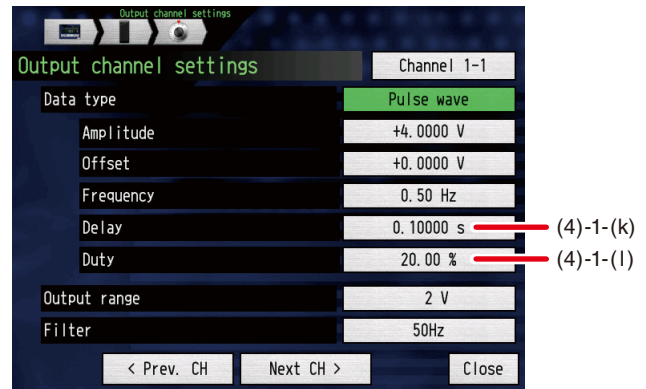

Item select		Examples of item		
(4)-1	(a)	DCO module	Output source	Built-in RAM, File
	(b)		File name	File selection
	(c)		Output sampling interval	10μs (100kS/s), 20μs (50kS/s), 50μs (20kS/s), 100μs (10kS/s), 200μs (5kS/s), 500μs (2kS/s), 1ms (1kS/s), 2ms (500S/s), 5ms (200S/s), 10ms (100S/s), 20ms (50S/s), 50ms (20S/s), 100ms (10S/s), 125ms (8S/s), 200ms (5S/s), 250ms (4S/s), 500ms (2S/s), 1s (1S/s), 2s, 5s, 10s, 20s, 30s, 1min, 2min, 5min, 10min, 20min, 30min, 1h
	(d)		Data points	1 to 128,000,000 points
	(e)		Read from the output source	Reading the file data conditions
	(f)	Setting (ALL, 1CH to 8CH)	Data type	Off, Data file, DC, Sine wave, Triangle wave, Ramp wave, Pulse wave
	(g)		Amplitude	0.000 to +20.000V
	(h)		Offset	-10.000 to +10.000V
	(i)		Frequency	0.00 to 10,000.00Hz
	(j)		Phase	-360.0 to +360.0deg.
	(k)		Delay	0.00000 to 100.00000sec.
	(l)		Duty	0.00 to 100.00%
	(m)		Output range	1, 2, 5, 10V
	(n)	Filter	Off, Line, 5 / 50 / 500Hz, 5 / 50kHz	
(o)	Data load	Reading the analog voltage output data and conditions		
(p)	Start output	Analog voltage output start / output stop		
(4)-2	Start / Stop synchronization		Off, On	

Item select		Examples of item
(4)-3	Repeat output	Off, On
(4)-4	Emergency stop alarm CH	Off, CH1, CH2, CH3, CH4, CH5, CH6, CH7, CH8, CH9, CH10
(4)-5	Output level at the time of Stop	0V, Retain
(4)-6	Data load	Reading the analog voltage output data and conditions
(4)-7	Start output	Analog voltage output start / output stop

(4)-1 DCO module settings

Set the Voltage Output Module (GL7-DCO).
This can be set from "Home" → "DCO module".

(4)-1-(a) Output source

Select the processing destination in which the analog voltage data has been recorded.
Built-in RAM: The data recorded in the built-in RAM in the module.
File: The data in the recording destination (storage media)

(4)-1-(b) File name

When the output source is set to File in (4)-1-(a), select the data file in the recording destination.
However, when the built-in RAM is selected, this item is not displayed.

CHECKPOINT

The file to be use here is GBD file data (binary format) only.
When the CSV file wave-generated by the GL-WaveEditor (software supplied with the GL-Connection) is saved, the CSV file can be converted to the GBD file data with the conversion saving function Refer to "Convert then save" in "11-11-2. File Operations") of the GL-Connection.

(4)-1-(c) Output sampling interval

The data output interval for the analog voltage output can be set within the range of 10 μ s to 1h.

(4)-1-(d) Data points

Set the data points for the analog voltage output. The data points can be set up to 128,000,000 points.

CHECKPOINT

When the data type is set to Data file, the data with more data points than the recording points is the same as the analog voltage of the last data in data file.

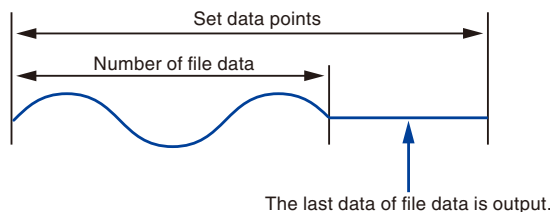

* When the set data points are less than the number of file data, the data for the set data points is output.

(4)-1-(e) Read from the output source

The sampling interval and the data points are read from the data in the output source (built-in RAM or file) set in (4)-1-(a), and then they are set to the output sampling interval in (4)-1-(c) and the data points in (4)-1-(d).

CHECKPOINT

When you set to Data file, please use the GL7000 after checking the followings. (GBD file data only is available.)

- If the data has not been saved to the built-in RAM or the specified file does not exist, the corresponding output CH will be 0V data.
- If specifying the CH that does not exist in the data file, the corresponding output CH will be 0V data.
- If specifying the CH recorded when "Temperature / Humidity and Logic / Pulse" are input in the data file, the corresponding output CH will be 0V data.
- In the data output sampling interval, the data is output with the output sampling interval set in "(4)-1-(c) Output sampling interval", regardless of the sampling interval recorded in the data file.

(4)-1-(f) Settings (Data type)

Select the data type and set the output conditions. The data in the data file is output within the set output range, regardless of the full scale range of the file.

The following table shows the settings and setting range.

Settings	Amplitude	Offset	Frequency	Phase	Delay	Duty
Data type	0 to 20V	±10V	0 to 10kHz	-360 to +360deg.	0 to 100sec.	0 to 100%
Data file	NG	NG	NG	NG	NG	NG
DC	OK	OK	NG	NG	NG	NG
Sine wave	OK	OK	OK	OK	NG	NG
Triangle wave	OK	OK	OK	OK	NG	NG
Ramp wave	OK	OK	OK	OK	NG	NG
Pulse wave	OK	OK	OK	NG	OK	OK

Sine wave

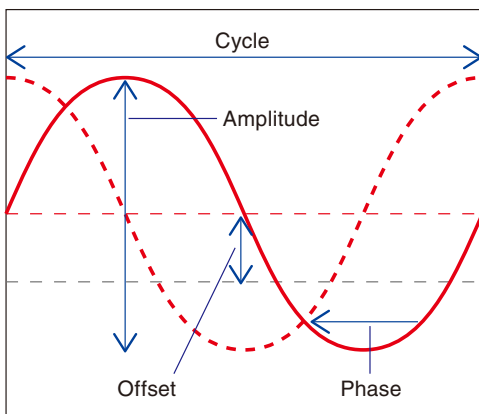

Triangle wave

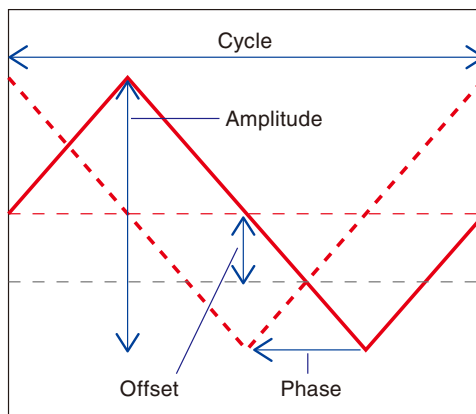

Ramp wave

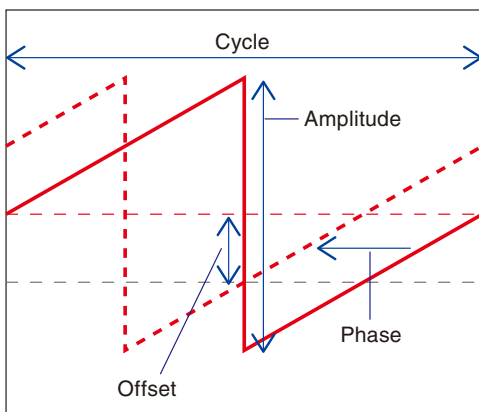

Pulse wave

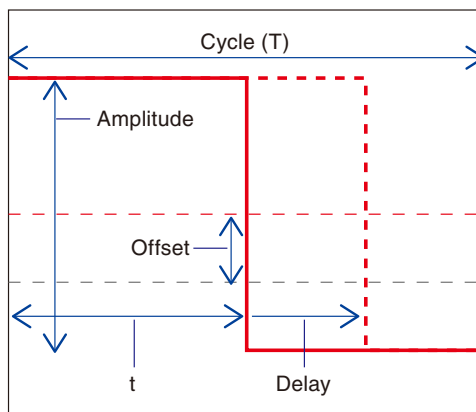

$$\text{Duty ratio} = \frac{t}{T}$$

(4)-1-(g) Setting (Amplitude)

The amplitude (P-P) can be set up to two times of the output range.

<Example> Output range 1V: Normal amplitude 1V (P-P), Maximum settable amplitude 2V (P-P)

(4)-1-(h) Setting (Offset)

The offset can be set within the output range.

<Example> Output range 1V: within the range of $\pm 1V$

(4)-1-(i) Setting (Frequency)

The frequency can be set within the range of 0.00 to 10000.00Hz.

Approx. 1/10 cycle of the output sampling interval is a criteria.

<Example> Sampling interval 1ms (1kHz): 0.01 to 100.00Hz

(4)-1-(j) Setting (Phase)

The phases of Sine wave, Triangle wave and Ramp wave can be set within the range of -360.0 to +360.0 deg.

(4)-1-(k) Setting (Delay)

When setting the pulse wave, the delay can be set within the range of 0.00000 to 100.0000sec.

(4)-1-(l) Setting (Duty)

When setting the pulse wave, the duty can be set within the range of 0.00 to 100.00%.

(4)-1-(m) Setting (Output range)

Set the analog voltage output.

The output range can be set to 1V, 2V, 5V or 10V. Maximum amplitude can be output up to two times of each range (Set in Amplitude screen).

(4)-1-(n) Setting (Filter)

A filter for the analog voltage output signal can be set.

This filter is a smoothing filter that removes the noise of the D/A converter.

CHECKPOINT

The filter for the output waveform should be set to Faster. If the filter is set to Slower, the waveform is may be shrunk or distorted.

(4)-1-(o) Data load

When changing the settings, the settings are confirmed by loading the data.

CHECKPOINT

- When the data load is not executed, the settings are not updated and remain the settings before changing. Make sure that the data load is executed.
- The data load operation is enabled when the output is stopped. It is not possible to operate the data load during data output. The following figure shows the displayed contents.

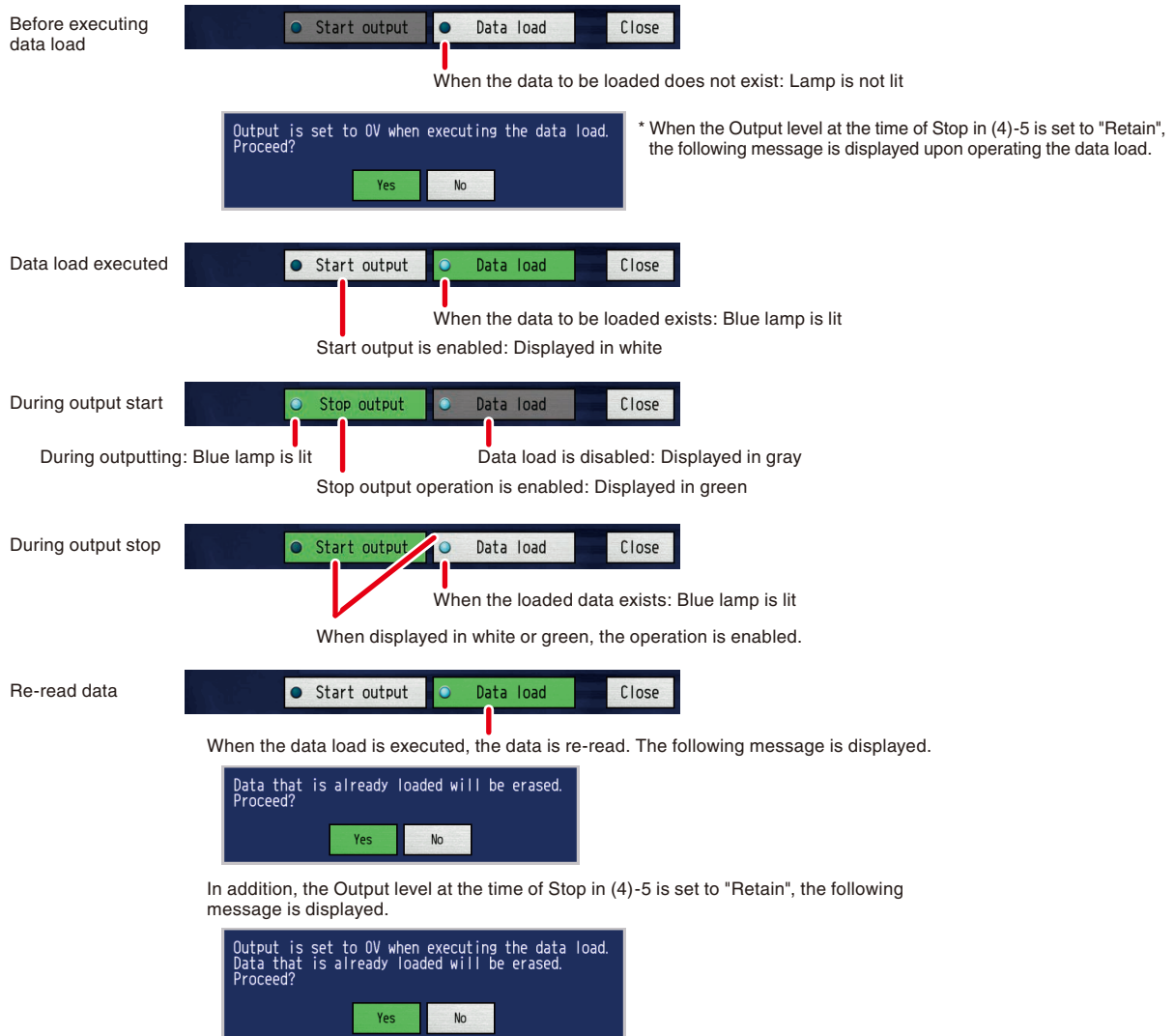

(4)-1-(p) Start output

When operating the Start output, the analog voltage output is executed.

To stop the analog voltage output, operate the Stop output.

When the start output key operation is disabled (displayed in gray), the data load is not executed. Make sure that the data load has been executed.

For the displayed contents, refer to "(4)-1-(o) Data load".

CHECKPOINT

- The analog voltage output at the time of stop conforms to the conditions set in "(4)-5 Output level at the time of Stop".
- * When the Output level at the time of Stop is set to "Retain", the voltage value at the time of stop is output.

(4)-2 Start/Stop synchronization

When the Start / Stop synchronization is set to On, the analog voltage output is started at the same time as the GL7000 start, and the output is stopped at the same time as the GL7000 stop (free-running state).

When the Start / Stop synchronization is set to Off, it is possible to operate the start output / stop output described in "(4)-1-(p) or (4)-7 Start output", regardless of the start / stop of GL7000.

CHECKPOINT

The analog voltage output at the time of stop conforms to the conditions set in "(4)-5 Output level at the time of Stop".

* When the Output level at the time of Stop is set to "Retain", the voltage value at the time of stop is output.

(4)-3 Repeat output

When the Repeat output is set to On, the analog voltage is repeatedly output until the stop operation is executed.

(4)-4 Emergency stop alarm CH output

When the alarm output CH is specified to the alarm module in the GL7000, the analog voltage output is forcibly stopped when the alarm occurs.

(4)-5 Output level at the time of Stop

The analog voltage output conditions when the output is stopped can be set.

0V: The analog voltage output is 0V.

Retain: The voltage value at the time of stop continues to output as the analog voltage output.

CAUTION

- When the analog voltage is output after setting to Retain, please take care in handling the equipment to be received.
 - To turn the analog voltage output to 0V, execute the re-load data.
-

(4)-6 Data load

This data load is linked with the operation described in "(4)-1-(o) Data load". So it is possible for both operations.

(4)-7 Start output

This Start output is linked with the operation of "(4)-1-(p) Start output". So it is possible to execute for both operations.

(5) Trigger/Alarm settings

Carries out trigger condition settings and alarm settings.

When dual sampling function is enabled under the trigger condition, it is the same as the setting on the Event (high-speed) capturing side.

("Home" → "Machine" → "Trigger/Alarm settings" or "Home" → "Amplifire settings" → "Trigger")

<Example 1> Start Trigger: Level
Stop Trigger: Alarm

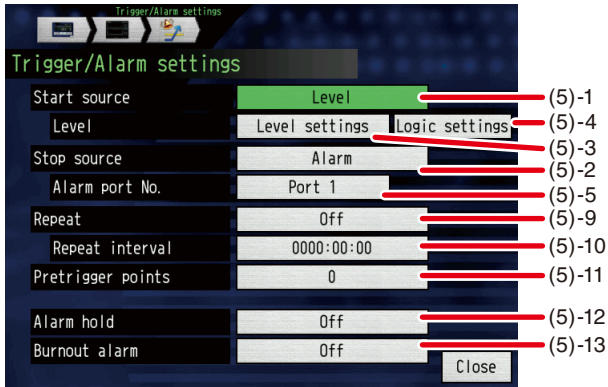

<Example 2> Start Trigger: Set time
Stop Trigger: Set date



<Example 3> Start Trigger: External input
Stop Trigger: Time interval

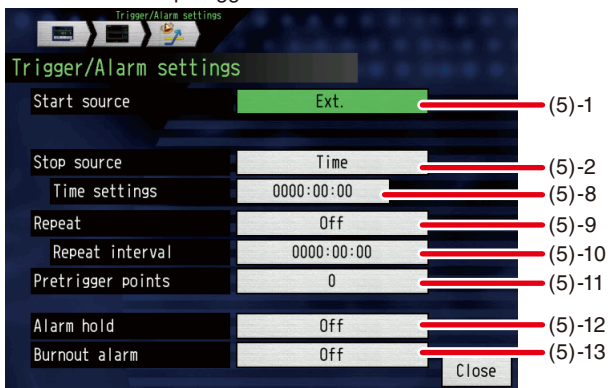

* Alarm levels and other detailed settings can not be set on this screen. Done in "Amplifire settings" → "Alarm settings"

Item select		Examples of item	
(5)-1	Start source	Off, Level, Alarm, Ext., Date, Weekly, Time	
(5)-3	Level	Level settings	
(5)-4		Logic settings	
(5)-5	Alarm	Alarm port number	1 to 10
(5)-6	Date	Date settings	Date: Jan. 1, 2000 to Dec. 31, 2035
		Time	Time: 00:00:00 to 23:59:59
(5)-7	Weekly	Weekly settings	Weekly: Set the days from Sunday to Saturday individually to On or Off
		Time	Time: 00:00:00 to 23:59:59
(5)-8	Time	Time settings	0:00:01 to 9999:59:59
(5)-2	Stop source	Off, Level, Alarm, External, Time, Date, Set	
(5)-3	Level	Level settings	
(5)-4		Logic settings	
(5)-5	Alarm	Alarm port No.	1 to 10
(5)-6	Date	Date settings	Date: Jan. 1, 2000 to Dec. 31, 2035
		Time	Time: 00:00:00 to 23:59:59
(5)-7	Weekly	Weekly settings	Weekly: Set the days from Sunday to Saturday individually to On or Off
		Time	Time: 00:00:00 to 23:59:59
(5)-8	Time	Time settings	0:00:01 to 9999:59:59
(5)-9	Repeat	Off, Between start and start, Between stop and start	
(5)-10	[ON]	Repeat interval	0:00:01 to 9999:59:59

Item select		Examples of item
(5)-11	Pretrigger points	0 to Number of recording points (Numerical entry)
(5)-12	Alarm hold	Off, On
(5)-13	Burnout alarm	Off, On

(5)-1 Start source

Set the trigger conditions for starting data recording.

Item select	Description
Off	If the Start/Stop button is pressed, recording starts regardless of condition settings.
Level	Recording starts if the conditions are satisfied at the level set. ⇒ When selecting the level value, the conditions for each CH is set. Refer to "(12) Trigger level settings" on page 3-128.
Alarm	Recording starts if an alarm occurs at a specified port.
Ext.	Recording starts at an input signal from the external trigger terminal (REMOTE terminal). * Trigger occurs when L (OV or shorted to GND) occurs. Operations will become edge operations. Please input a signal over 500 μ s.
Date	Recording starts at a specified date and time.
Weekly	Recording starts at a specified time on the date it's set to On. <Ex.>: Set Mon, Tue, Wed, Thu, Fri to On and Sun, Sat to Off and specify the time as 9:00. Recording starts at 9:00 on weekdays. Recording is not started on a Saturday.
Time	Recording starts when the specified time has elapsed.

(5)-2 Stop source

Set trigger conditions for stopping data recording.

Item select	Description
Off	If the Start/Stop button is pressed, recording stops regardless of condition settings.
Level	Recording stops if the conditions are satisfied at the level set. ⇒ When selecting the level value, the conditions for each CH is set. Refer to "(12) Trigger level settings" on page 3-128.
Alarm	Recording starts if an alarm occurs at a specified port.
Ext.	Recording stops at an input signal from the external trigger terminal (REMOTE terminal). * Trigger occurs when L (OV or shorted to GND) occurs. Operations will become edge operations. Please input a signal over 500 μ s.
Date	Recording stops at a specified date and time.
Weekly	Recording stops at a specified time on the date it's set to On. <Ex.>: Set Mon, Tue, Wed, Thu, Fri to On and Sun, Sat to Off and specify the time as 9:00. Recording starts at 9:00 on weekdays. Recording is not started on a Saturday.
Time	Recording stops when the specified time has elapsed.

CHECKPOINT

When using the stop trigger, set the interval between the start side and stop side to 1 ms or more. If the trigger on the stop side occurs within 1 ms after the trigger on the start side occurs, the recording stops after 1 ms elapsed from the start side. However when the recording destination is the built-in RAM, the recording stops within 1 ms at the point that the number of recording points are exceeded.

(5)-3 Level settings

For details, refer to "(12) Trigger level settings" on page 3-128.

(5)-4 Logic settings

For details, refer to "(12) Trigger level settings" on page 3-128.

(5)-5 Alarm port number

If an alarm occurs at the port specified here, a start or stop trigger is established.

(5)-6 Date setting

Set the date and time. At the set date and time, a start or stop trigger is established.

(5)-7 Weekly settings

Set weekly and time. Sets the weeklys from Sunday to Saturday individually to On or Off. At a specified time on a weekly set to On, a start or stop trigger is established.

(5)-8 Time settings

If the specified time has elapsed, a start or stop trigger is established.

(5)-9 Repeat

Set the repeat function for performing repeat recording.

* This setting can only be set when the recording destination is the built-in RAM or when the stop side source is not set to Off.

Item select	Description
Off	Cannot use the repeat function.
Between start and start	Repeat function enabled. After 1 recording has finished, the next recording will start. (If the start side source is set to On, recording will become trigger dependent.) When repeat interval is set, when repeat interval is reached from the start of capturing, the next capturing starts.
Between stop and start	Repeat function enabled. After 1 recording has finished, the next recording will start. (If the start side source is set to On, recording will become trigger dependent.) When repeat interval is set, when repeat interval is reached from the stop of capturing, the next capturing starts.

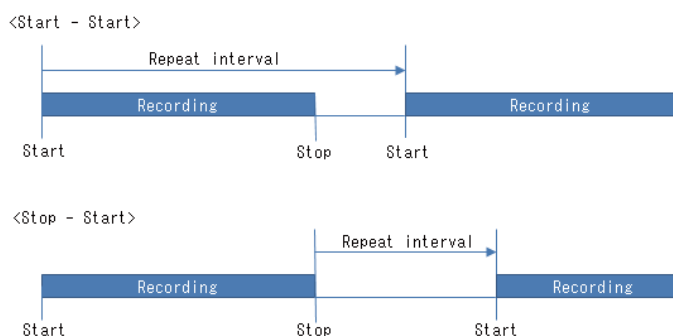

<Repeat settings table>

Recording destination	Stop side trigger source						
	Off	Level	Alarm	Ext.	Date	Weekly	Time
RAM	OK	OK	OK	OK	OK	OK	OK
Internal FLASH	NG	OK	OK	OK	OK	OK	OK
SD Card	NG	OK	OK	OK	OK	OK	OK
SSD Module	NG	OK	OK	OK	OK	OK	OK

OK: Settings available

(5)-10 Repeat interval

When repeat capturing is set to other than Off, set the repeat interval.

As soon as the time set in the repeat interval has elapsed, the recording start processing is performed, waiting to be triggered again.

CHECKPOINT

Depending on the state (such as space, number of files) of the recording destination, the processing may take a long time to start recording.

Therefore, it may take some time until the waiting for a trigger after the repeat interval has elapsed.

(5)-11 Pretrigger points

Set the number of recording points for the recorded data before a trigger occurs.

* This can only be selected if the Pretrigger points is set to record to the built-in RAM, and the start side source is set to a level value or an external input.

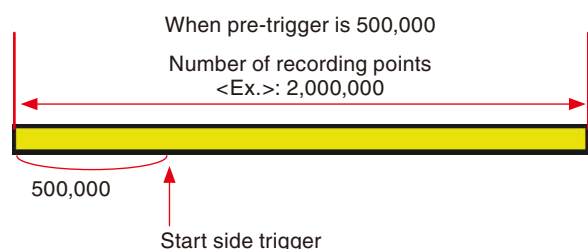

<Pretrigger points settings table>

Recording destination	Stop side trigger source						
	Off	Level	Alarm	Ext.	Date	Weekly	Time
RAM	NG	OK	OK	OK	OK	OK	OK
Internal FLASH	NG	NG	NG	NG	NG	NG	NG
SD Card	NG	NG	NG	NG	NG	NG	NG
SSD Module	NG	NG	NG	NG	NG	NG	NG

OK: Settings available

(5)-12 Alarm hold

If "Alarm hold" is selected here, once the established conditions have been met the alarm status will not be cleared, regardless of whether or not the conditions continue to be met (Touching the function button or "QUIT" key on the screen will clear it.)

CHECKPOINT

When the combination of the alarms is set to "Edge OR" or "Edge AND", the alarms are retained regardless of this setting.

When the alarms are not retained, set the combination of the alarms to "Level OR" or "Level AND".

(5)-13 Burnout alarm

If "Occurs" is selected here, when a burnout (refer to "(3) Burn out" on page 3-98) occurs, an alarm is output from the alarm output terminal. From the CH settings screens it is possible to set the number for the output destination.

(For details, see ""(13)-4 Output" on page 3-134)

(6) I/F, USB settings

Set the conditions for connecting to a computer. Ethernet settings are set in the network settings, a different menu.

("Home" → "Machine" → "I/F, USB settings")

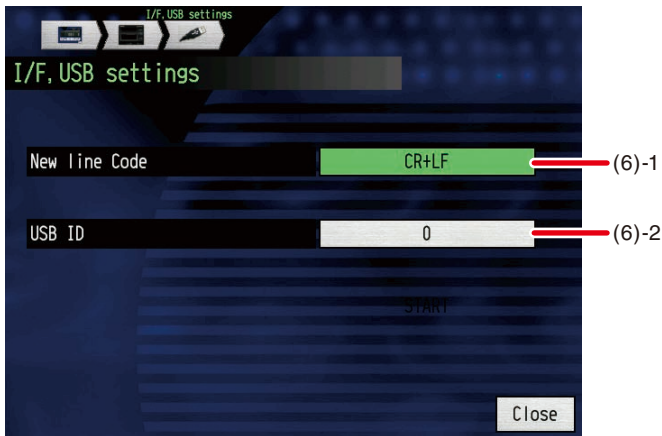

Item select		Examples of item
(6)-1	New line Code	CR+LF, LF, CR
(6)-2	USB ID	0 to 9

(6)-1 New line Code

Set the lower line character for managing with I/F commands.

Item select	Description
CR+LF	Line break with CR/LF
LF	Line break with LF
CR	Line break with CR

(6)-2 USB ID

Set the USB ID number for the GL7000.

It can be set between 0 and 9.

When managing multiple machines with 1 computer, please set the USB IDs so that they do not overlap.

(7) IP settings

Settings for connecting to the GL7000 by Ethernet.

("Home" → "Machine" → "Network settings" → " IP settings")



Item select	Examples of item
(7)-1 IP address auto acquire	On (Use), Off (Don't use)
(7)-2 IP Address	0 to 255
(7)-3 Subnet mask	0 to 255
(7)-4 Port number	1024 to 65535
(7)-5 Gateway	0 to 255
(7)-6 DNS address	0 to 255
(7)-7 Keep alive	Off, 10 and 30 sec., 1, 10 and 30 min., 1 hr.
(7)-8 ID Name	Text entry
(7)-9 Restart network	▷ Execute

CHECKPOINT

Settings (7)-1 through (7)-6 manage network connections for the GL7000. Please consult you network administrator before making any changed.

(7)-1 IP address auto acquire

Set whether the IP address should be acquired automatically or entered manually.

Item select	Description
On (Use)	Set it to automatic acquisition. (7)-2, (7)-3, (7)-5, (7)-6 cannot be selected. * When setting it to "Use", the automatic acquisition action (occurs when the power is turned on or when executing settings reflecting) may take from a few seconds up to 1 minute.
Off (Don't use)	Set it to manual entry. Please set the (7)-2 to (7)-6 items in the table above.

<When IP address is successfully auto-accrued>

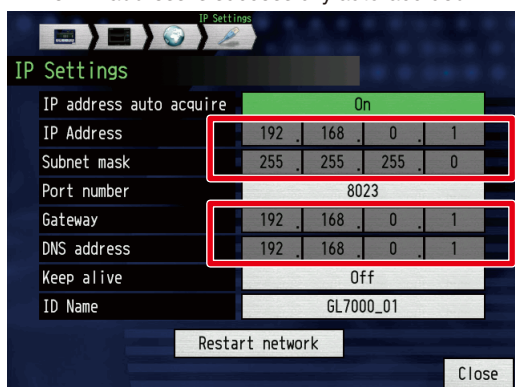

< When IP address is not auto-accrued>

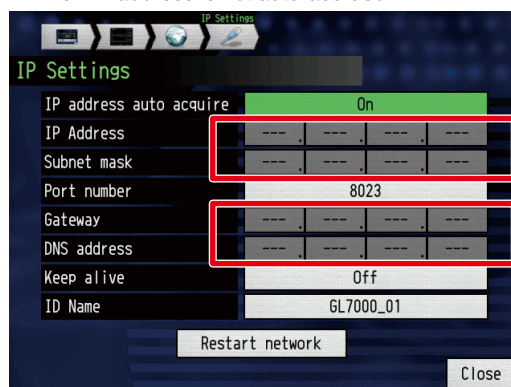

After a successful automatic acquisition, the automatically set IP address is displayed.

⚠ CAUTION

- When an IP address cannot be acquired despite automatic IP address acquisition being set to "Use" (refer to the following chart), operate by manually setting IP address contents etc. As the IP address may not fit the used network settings, please set automatic IP address acquisition to "Don't use" and enter settings here.
- When changing IP settings, turn the power off and on, or execute "Network restart". (The connection will be forcibly disabled.)

(7)-2 IP address

Set the IP address for the GL7000.

This can only be set when the machine is set to manual IP address entry.

(7)-3 Subnet mask

Set the subnet mask for the GL7000.

This can only be set when the machine is set to manual IP address entry.

(7)-4 Port number

Set the port number for the GL7000.

(7)-5 Gateway

Set the gateway address for the GL7000.

This can only be set when the machine is set to manual IP address entry..

(7)-6 DNS address

Set the DNS address for the GL7000.

This can only be set when the machine is set to manual IP address entry.

(7)-7 Keep alive

Detects the Keep Alive and automatically disconnects the socket connector.

Item select	Description
Off	Disconnection is not performed.
10 and 30 sec., 1, 10 and 30 min., 1 hr.	Lack of activity over a certain amount of time will lead to the socket connection being disconnected. Please engage the machine within that time limit. (This function is only enabled for the command port. It has no effect on the Web server and FTP server functions.)

(7)-8 ID Name

Set the name for identifying the attached application.

* This identification name is neither a general computer name (NETBIOS name) nor a name for DNS use.

(7)-9 Restart network

For instantly reflecting IP settings contents.

* When executing settings reflecting, the connection will be forcibly cut.

* Executing settings reflecting may take from a few seconds up to 1 minute.

(8) FTP server settings

Set information concerning the connected FTP server for backup, etc.

("Home" → "Machine" → "Network settings" → "FTP Server settings")

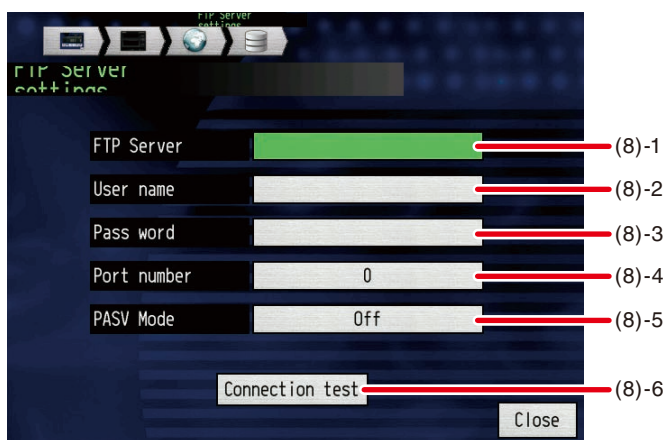

Item select		Examples of item
(8)-1	FTP Server	Text entry
(8)-2	User name	Text entry
(8)-3	Pass word	Text entry
(8)-4	Port number	0 to 65535
(8)-5	PASV Mode	Off, On
(8)-6	Connection test	▷ Execute

(8)-1 FTP Server

Enter the FTP server domain name or IP address.

(8)-2 User name

Enter the FTP account user name.

(8)-3 Pass word

Enter the FTP account password.

(8)-4 Port number

Enter the port number used with FTP. Normally this number is 21.

(8)-5 PASV Mode

Set the passive mode.

Item select	Description
Off	Set when communicating with the FTP server in a normal network environment.
On	Set when communicating with an external firewall in a firewalled network environment.

(8)-6 Connection test

Carries out connection test on the FTP server. A message is displayed when carrying out the connection test. If connection cannot be made, please check setting and test again.

* If the connection test comes out OK, the message below is displayed.

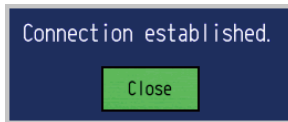

CHECKPOINT

- If the factory settings are used and the setting conditions are initialized, the settings for the FTP server are also initialized.
 - If the configuration of the modules is changed, the setting conditions is initialized and then the settings for FTP serve are also initialized.
-

(9) Date/Time settings

Settings related to the clock.

Here you can set the GL7000 built-in clock (date and time). Further, by setting the network time, the GL7000 clock can be automatically adjusted via the network.

("Home" → "Machine" → "Date/Time settings")

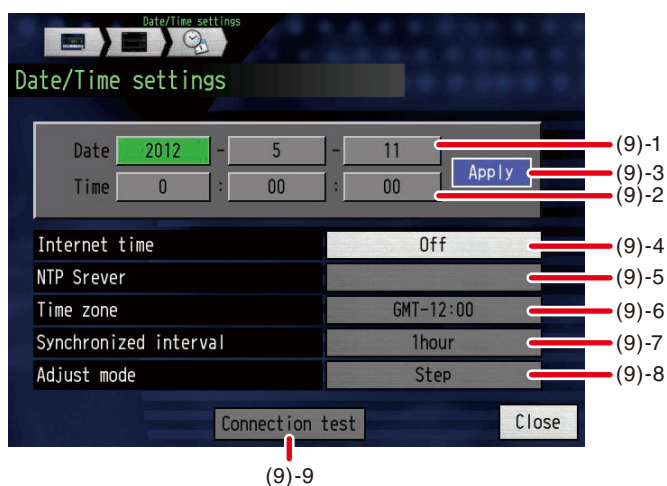

Item select		Examples of item
(9)-1	Date	Jan. 1, 2000 to Dec. 31, 2035
(9)-2	Time	00:00:00 to 23:59:59
(9)-3	Apply	▷ Execute
(9)-4	Internet time	Off, On
(9)-5	NTP server	Text entry
(9)-6	Time zone	-12:00 to +13:00 (hourly)
(9)-7	Synchronized interval	1, 2, 6, 12 and 24 hrs
(9)-8	Adjust mode	Step, Slew
(9)-9	Connection test	▷ Execute

(9)-1 Date

Set the date. By pressing the "Apply" button, settings are reflected

(9)-2 Time

Set the time. By pressing the "Apply" button, settings are reflected.

(9)-3 Apply

By pressing this button, date/time settings are reflected.

(9)-4 Internet time

Set whether or not to use this function.

Item select	Description
Off	This function is not used. Time adjustment not implemented.
On	Using this function, time adjustment implemented

(9)-5 NTP server

Input the domain name of the time server (NTP server) in use.

(9)-6 Time zone

Set the time zone for the area the GL7000 is being used in.

(9)-7 Synchronized interval

Set the interval for synchronizing to the time server. Time synchronization is performed in the way set in synchronization mode settings when the synchronization interval is up. The elapsed time measurement can be set when this item is set or following startup.

(9)-8 Adjust mode

Set the synchronization method to the clock server.

Item select	Description
Step	When the synchronization interval elapses, the time is immediately set using the server time.
Slew	Even if the synchronization interval elapses, immediate synchronization is not carried out. The time is gradually synchronized to the server time. The adjustment amount is approx. 43 seconds/day. (20 seconds is about 10ms of adjustment amount.)

(9)-9 Connection test

Carries out a connection test to the time server.

A message is displayed when carrying out the connection test. If connection cannot be made, please check the settings and test again.

* If the connection test is OK, the message below is displayed.

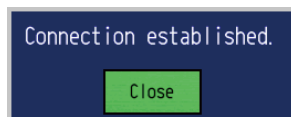

CHECKPOINT

- If the factory settings are used and the setting conditions are initialized, the settings for the FTP server are also initialized.
- If the configuration of the modules is changed, the setting conditions is initialized and then the settings for FTP server are also initialized.

(10) Other settings

Various setting conditions can be set.

("Home" → "Machine" → "Other Settings")



Item select		Examples of item	
(10)-1	Power on start	Disable / Enable	
(10)-2	Start / Stop confirmation message	On / Off	
(10)-3	AC line cycle (GL7-M)	50Hz / 60Hz	
(10)-4	Temperature setting	Temperature unit	°C / °F
		Room temperature compensation	Internal / External
		Burnout	Off / On
(10)-5	Auto balance button	Unit / All units	
(10)-6	Strain unit (GL7-DCB)	μ , mV/V	
(10)-7	Demo waveform mode	Off / On	
(10)-8	LCD brightness	Brighter, Bright, Medium, Dark, Darker	
(10)-9	Screen saver	Off, 10 / 30 s; 1, 2, 5, 10, 30, 60 min	
(10)-10	Key click	Off / On	
(10)-11	Language	Japanese, English(US), English(UK), French, German, Chinese, Korean	
(10)-12	Information	Information display	

(10)-1 Power on start

Set the function for automatically starting recording at set conditions when the power is turned on.

Item select	Description
Disable	Will not start recording when powered.
Enable	Will start recording when powered.

CHECKPOINT

- When this function is set to "Enable" and the start side trigger is not set to OFF, turning the power on becomes a time dependent trigger and recording will not start until the trigger is activated.
- When using the Voltage Output Module, even if the power is turned on after setting "Power-on start" or "Start / Stop synchronization" of the Voltage Output Module, the voltage output is not performed. Users must be operated manually in the DCO module settings

(10)-2 Start / Stop confirmation message

A confirmation message is displayed when capturing starts and capturing stops. It can be switched to Off in the confirmation message.

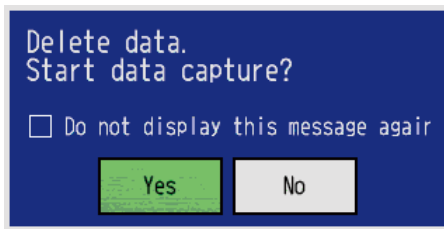

(10)-3 AC Line cycle

This is set for an option module GL7-M only. Set the frequency of the AC power source in use.

Item select	Description
50Hz	For a region with a power frequency of 50Hz.
60Hz	For a region with a power frequency of 60Hz.

⚠ CAUTION

- This setting is a disposable frequency for the Voltage/Temperature digital file.
- Please note that setting this mistakenly may mean that the noise from the power source cannot be cancelled out.
- The sample interval where the digital file is enabled is over 500ms.

(10)-4 Temperature setting

This is set for an option module GL7-M only. Set temperature related settings.

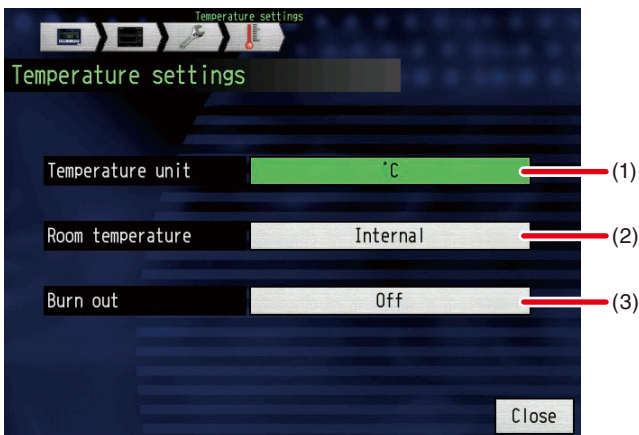

Item select	Description
(1) Temperature unit	Changes between °C (Celsius) and °F (Fahrenheit) settings.
(2) Room temperature	Set whether to enable or disable the GL7000 room temperature compensation.
(3) Burn out	Set the thermocouple disconnection check function.

- (1) Temperature unit
 °F (Fahrenheit) is calculated with the following formula.

$$^{\circ}\text{F (Fahrenheit)} = ^{\circ}\text{C (Celsius)} \times 1.8 + 32$$

⚠ CAUTION

- Regarding accuracy, please calculate an accurate Celsius $\times 1.8$.
- Temperature can be measured in Fahrenheit is up to 2900°F. If the temperature exceeds 2900°F, "+++++" is displayed.

(2) Room temperature

Item select	Description
Internal	Room temperature compensation is enabled for the GL7000. (Recommended)
External	Set when performing room temperature compensation for an external machine.

(3) Burn out

Item select	Description
Off	Disconnection check is not done.
On	Disconnection checks are made periodically.

⚠ CAUTION

Voltage is applied during disconnection checks. When in a parallel connection with other machines, please set this to Off as it can have an effect on the other machines.

(10)-5 Auto balance button (GL7-DCB)

It is the setting only for GL7-DCB (option unit).

When connecting multiple strain units (GL7-DCB), auto balancing of multiple strain units can be performed at once with the auto balance button on the strain unit.

Item select	Description
Unit	Auto balance is performed only for the unit which the auto balance button is pressed.
All units	Auto balancing of all connected strain units are performed.

(10)-6 Strain unit

It is the setting only for GL7-DCB (option unit).

Set the strain unit when the input setting of the strain unit (GL7-DCB) is set to strain gauge or strain sensor.

(10)-7 Demo waveform

Displays a demo waveform, without inputting an analogue signal.

Item select	Description
Off	Demo waveform is not displayed.
On	Demo waveform is displayed.

CHECKPOINT 

Since GL7000 starts up as if one pseudo-Voltage module (GL7-V) is installed even if the Amplifier module has not been installed, you can verify the demo waveforms.

(10)-8 LCD brightness

Set the LCD backlight brightness.

When set darker, LCD life can be prolonged.

(10)-9 Screen saver

Turns the screen Off automatically, at a specified time during inactivity.

The life span of the LCD screen may be prolonged by frequently turning off the screen.

(10)-10 Key click

Set the sound for key operations of the GL7000.

Select from On, Off.

(10)-11 Language

Set the GL7000 display language.

(10)-12 Information

Displays the GL7000 system information.

(11) Input settings

Mainly used for input signal settings.

("Home" → "Each Amplifier Module" → "Channel settings" → "Input settings")

<Voltage module (GL7-V)>

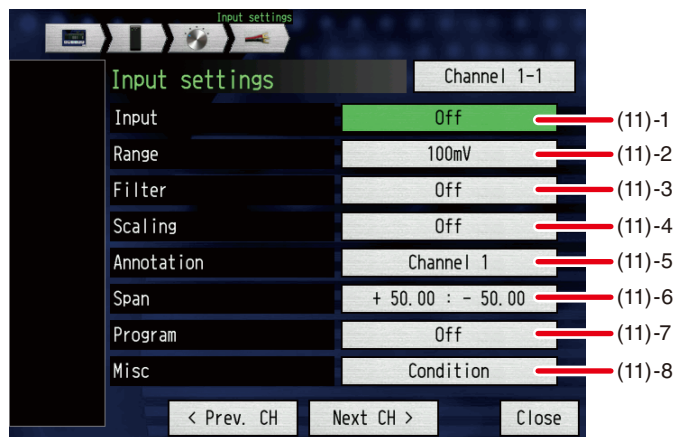

Item select		Examples of item			
(11)-1	Input	Off, DC			
(11)-2	Range	100/200/500mV, 1/2/5/10/20/50/100V, 1-5V			
(11)-3	Filter	Off, Line, 5/50/500Hz			
(11)-4	Scaling	Scaling	Off, On		
		Meas. Value	Upper limit value	Numerical entry	
			Lower limit value	Numerical entry	
		Scal. Value	Upper limit value	Numerical entry	
			Lower limit value	Numerical entry	
		Decimal point	+1.0000, +10.000, +100.00, +1000.0, +10000		
		Select	Categories	Current, Length, Area, Volume, Acceleration, Frequency, Mass, Energy, Pressure, Flow, Temperature, Strain	
			Unit selection	(Item selection changes depending on the groups mentioned above)	
Unit	The above unit selection result or Text entry.				
(11)-5	Annotation	Text entry (up to 31 characters)			
(11)-6	Span	Upper limit value	Numerical entry		
		Lower limit value	Numerical entry		
(11)-7	Program	Inter-Ch Op.	Off, On		
		Operation	CH-X (Function) CH-Y CH-X : CH1 to CH112 Function : Four arithmetic operations (+, -, ×, ÷) CH-Y : CH1 to CH112		
		Scaling	/1000000, 1000, ×1, ×1000, ×1000000		
	Span	Upper level	-100000 to +100000 (Numerical entry)		
		Lower level	-100000 to +100000 (Numerical entry)		
		Decimal point	+1.0000, +10.000, +100.00, +1000.0, +10000		
	Select Unit	Categories	Current, Length, Area, Volume, Acceleration, Frequency, Mass, Energy, Pressure, Flow, Temperature, Strain		
		Unit selection	(Item selection changes depending on the groups mentioned above)		
Unit	The above unit selection result or Text entry				
(11)-8	Misc	Waveform color setting	Red, Green, Blue (RGB) Each color 0 to 31		
		Thickness setting	1 to 8dots		
		Perform auto zero ADJ.	▷ Execute		
		Reset auto zero ADJ.	▷ Execute		

<Voltage/Temperature Module (GL7-M)>

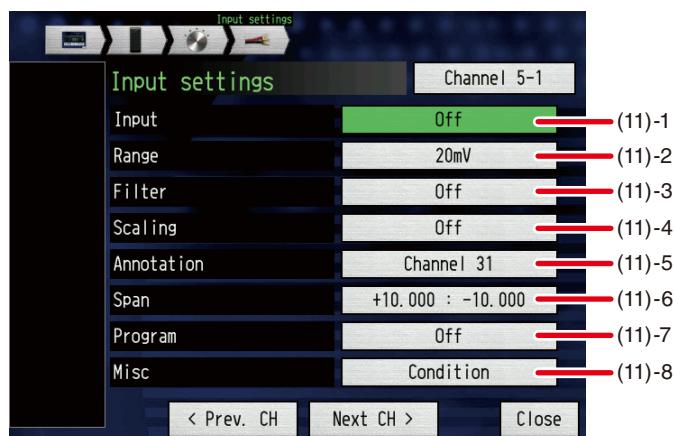

Item select		Examples of item		
(11)-1	Input	Off, DC, TEMP, RH		
(11)-2	Range	DC	20/50/100/200/500mV, 1/2/5/10/20/50V, 1-5V	
		TEMP	TC-K, TC-J, TC-T, TC-R, TC-E, TC-B, TC-S, TC-N, TC-C (TC-W), Pt100, JPT100, Pt1000	
(11)-3	Filter	Off, 2 to 5, 10, 20, 40		
(11)-4	Scaling	[Voltage]	Scaling	Off, On
		Meas. Value	Upper limit value	Numerical entry
			Lower limit value	Numerical entry
		Scal. Value	Upper limit value	Numerical entry
			Lower limit value	Numerical entry
		Decimal point		+1.0000, +10.000, +100.00, +1000.0, +10000
		Select	Categories	Current, Length, Area, Volume, Acceleration, Frequency, Mass, Energy, Pressure, Flow, Temperature, Strain
			Unit selection	(Item selection changes depending on the groups mentioned above)
		Unit		The above unit selection result or Text entry
		[Temperature]	Scaling	Off, On
			Adjust	Meas. Value
		Scal. Value		Numerical entry
		Read current		Reflects the current measured values
		Select	Categories	Current, Length, Area, Volume, Acceleration, Frequency, Mass, Energy, Pressure, Flow, Temperature, Strain
Unit selection	(Item selection changes depending on the groups mentioned above)			
Unit		The above unit selection result or Text entry		
(11)-5	Annotation	Text entry (up to 31 characters)		
(11)-6	Span	Upper limit value	Numerical entry	
		Lower limit value	Numerical entry	
(11)-7	Program	Inter-Ch Op.	Off, On	
		Operation		CH-X (Function) CH-Y CH-X : CH1 to CH12 Function: Four arithmetic operations (+, -, ×, ÷) CH-Y : CH1 to CH12
		Scaling		/1000000, /1000, ×1, ×1000, ×1000000
		Span	Upper level	-100000 to +100000 (Enter a number)
			Lower level	-100000 to +100000 (Enter a number)
			Decimal point	+1.0000, +10.000, +100.00, +1000.0, +10000
		Select Unit	Categories	Current, Length, Area, Volume, Acceleration, Frequency, Mass, Energy, Pressure, Flow, Temperature, Strain
			Unit selection	(Item selection changes depending on the groups mentioned above)
Unit		The above unit selection result or Text entry		
(11)-8	Misc	Waveform color setting	Red, Green, Blue (RGB) Each color 0 to 31	
		Thickness setting	1 to 8dots	
		Perform auto zero ADJ.	▷ Execute	
		Reset auto zero ADJ.	▷ Execute	

* Pt1000: IEC751 compatible

<High Speed Voltage Module (GL7-HSV)>

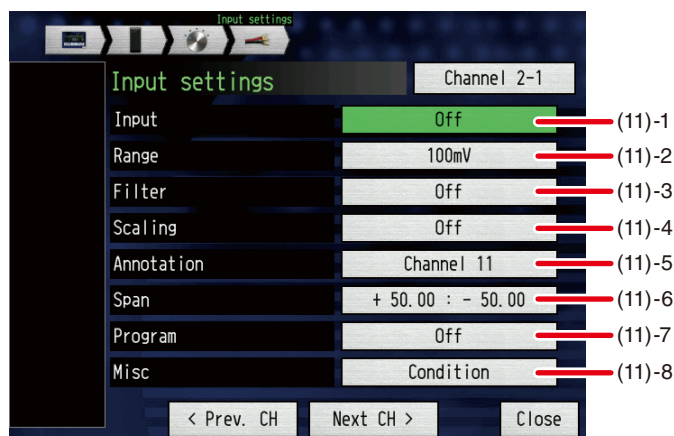

Item select		Examples of item		
(11)-1	Input	Off, DC		
(11)-2	Range	100/200/500mV, 1/2/5/10/20/50/100V, 1-5V		
(11)-3	Filter	Off, Line, 5/50/500Hz, 5/50kHz		
(11)-4	Scaling	Scaling	Off, On	
		Meas. Value	Upper limit value	Numerical entry
			Lower limit value	Numerical entry
		Scal. Value	Upper limit value	Numerical entry
			Lower limit value	Numerical entry
		Decimal point	+1.0000, +10.000, +100.00, +1000.0, +10000	
		Select	Categories	Current, Length, Area, Volume, Acceleration, Frequency, Mass, Energy, Pressure, Flow, Temperature, Strain
Unit selection	(Item selection changes depending on the groups mentioned above)			
Unit		The above unit selection result or Text entry		
(11)-5	Annotation	Text entry (up to 31 characters)		
(11)-6	Span	Upper limit value	Numerical entry	
		Lower limit value	Numerical entry	
(11)-7	Program	Inter-Ch Op.	Off, On	
		Operation	CH-X (Function) CH-Y CH-X: CH1 to CH12 Function: Four arithmetic operations (+, -, ×, ÷) CH-Y: CH1 to CH12	
	Scaling	/1000000, /1000, ×1, ×1000, ×1000000		
	Span	Upper level	-100000 to +100000 (Numerical entry)	
		Lower level	-100000 to +100000 (Numerical entry)	
		Decimal point	+1.0000, +10.000, +100.00, +1000.0, +10000	
	Select Unit	Categories	Current, Length, Area, Volume, Acceleration, Frequency, Mass, Energy, Pressure, Flow, Temperature, Strain	
Unit selection		(Item selection changes depending on the groups mentioned above)		
Unit		The above unit selection result or Text entry		
(11)-8	Misc	Waveform color setting	Red, Green, Blue (RGB) Each color 0 to 31	
		Thickness setting	1 to 8dots	
		Perform auto zero ADJ.	▷ Execute	
		Reset auto zero ADJ.	▷ Execute	

<Logic/Pulse Module (GL7-L/P)>

<When channel is set as logic>

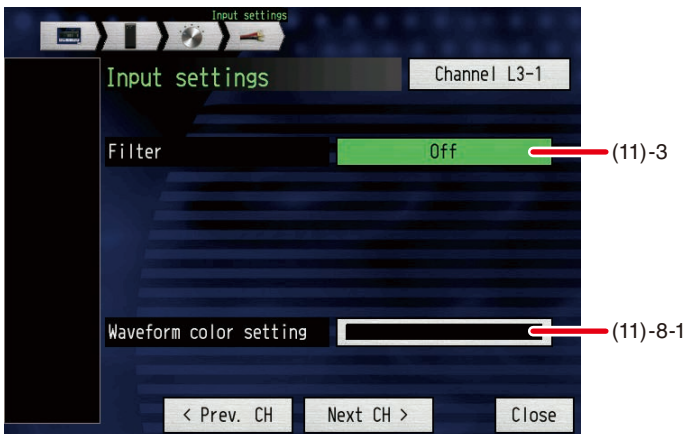

<When channel is set as pulse>

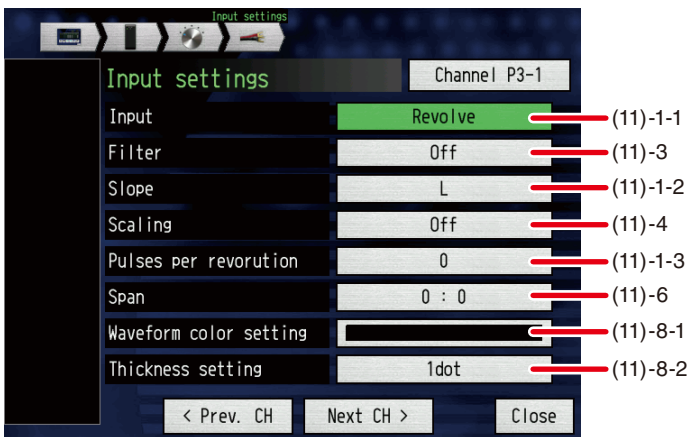

Item select		Examples of item	
(11)-1-1	Input	Off, Revolve, Counts, Instant	
(11)-1-2	Slope	L, H	
(11)-1-3	Number of pulses per revolution	Numerical entry (1 to 10000)	
(11)-3	Filter	Off, On	
(11)-4	Scaling	Scaling	Off, On
		Meas. Value	Upper limit value Numerical entry
		Scal. Value	Upper limit value Numerical entry
		Select	Categories Current, Length, Area, Volume, Velocity, Acceleration, Frequency, Mass, Energy, Pressure, Flow, Temperature, Strain
		Unit	Unit selection (Item selection changes depending on the groups mentioned above)
(11)-6	Span	Upper limit value	Numerical entry
		Lower limit value	Numerical entry
(11)-8-1	Waveform color setting	Red, Green, Blue (RGB) Each color 0 to 31	
(11)-8-2	Thickness setting	1 to 8dots	

CHECKPOINT

- To switch between the Logic and Pulse, touch the "Pulse/Logic" select button on the Channel setting screen ("Home" → (Each Amplifier Module) → "Channel settings")
- If multiple Logic/Pulse modules (GL7-LP) are installed and the switching between the Logic and Pulse is performed, please note that since the internal channel number setting is modified, the setting conditions of Logic/Pulse module are changed.

<High-voltage Module (GL7-HV)>

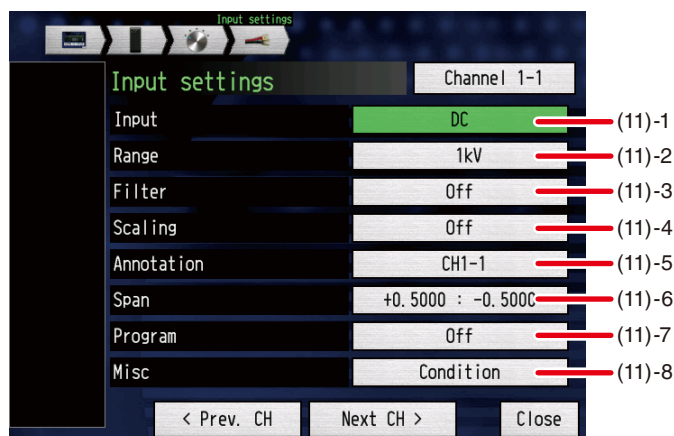

Item select		Examples of item		
(11)-1	Input	Off, DC, AC, DC-RMS, AC-RMS		
(11)-2	Range	DC, AC : 2, 5, 10, 20, 50, 100, 200, 500, 1000 V F.S. DC-RMS, AC-RMS: 1, 2, 5, 10, 20, 50, 100, 200, 500 V F.S.		
(11)-3	Filter	Off, Line, 5/50/500Hz, 5/50kHz		
(11)-4	Scaling	Scaling	Off, On	
		Meas. Value	Upper limit value	Numerical entry
			Lower limit value	Numerical entry
		Scal. Value	Upper limit value	Numerical entry
			Lower limit value	Numerical entry
		Decimal point	+1.0000, +10.000, +100.00, +1000.0, +10000	
		Select	Categories	Current, Length, Area, Volume, Acceleration, Frequency, Mass, Energy, Pressure, Flow, Temperature, Strain
Unit selection	(Item selection changes depending on the groups mentioned above)			
	Unit	The above unit selection result or Text entry		
(11)-5	Annotation	Text entry (up to 31 characters)		
(11)-6	Span	Upper limit value	Numerical entry	
		Lower limit value	Numerical entry	
(11)-7	Program	Inter-Ch Op.	Off, On	
		Operation	CH-X (Function) CH-Y CH-X: CH1 to CH112 Function: Four arithmetic operations (+, -, ×, ÷) CH-Y: CH1 to CH112	
	Scaling	/1000000, /1000, ×1, ×1000, ×1000000		
	Span	Upper level	-100000 to +100000 (Numerical entry)	
		Lower level	-100000 to +100000 (Numerical entry)	
		Decimal point	+1.0000, +10.000, +100.00, +1000.0, +10000	
	Select Unit	Categories	Current, Length, Area, Volume, Acceleration, Frequency, Mass, Energy, Pressure, Flow, Temperature, Strain	
Unit selection		(Item selection changes depending on the groups mentioned above)		
	Unit	The above unit selection result or Text entry		
(11)-8	Misc	Waveform color setting	Red, Green, Blue (RGB) Each color 0 to 31	
		Thickness setting	1 to 8dots	
		Perform auto zero ADJ.	▷ Execute	
		Reset auto zero ADJ.	▷ Execute	

<Strain unit Module (GL7-DCB)>

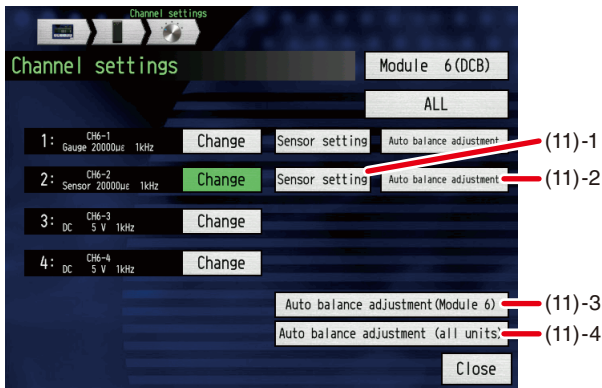

<Example : Sensor setting>

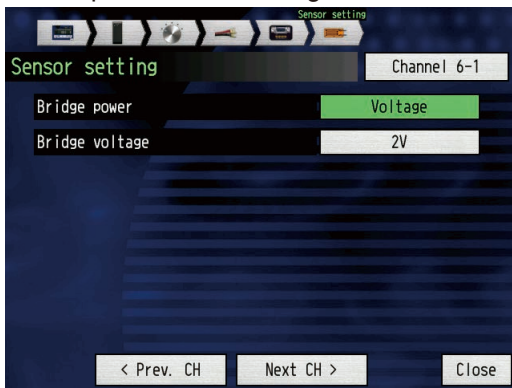

<Example : Sensor setting>

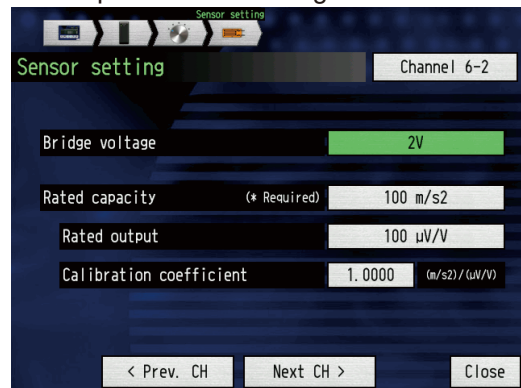

Item select		Examples of item					
(11)-1	Sensor setting	Strain gauge	Bridge power supply	Quarter, Half bridge	Voltage	Voltage fixing	
				Full bridge	Voltage	Voltage fixing	
			Bridge voltage	Quarter, Half bridge	Voltage	1, 2, 2.5, 5, 10V	
				Full bridge	Constant current	Target bridge voltage	
		Strain sensor	Bridge voltage		1, 2, 2.5, 5, 10V (Gauge resistance value, current value calculation display)		
			Rated capacity	Decimal point	+1.0000, +10.000, +100.00, +1000.0, +10000.0		
				Rated capacity	Numerical entry.		
				Unit selection	Voltage, Current, Length, Area, Volume, Speed, Acceleration, Frequency, Mass, Energy, Pressure, Flow rate, Temperature, Strain, Brightness, Concentration, Arbitrary		
			Rated output	Unit	Above unit selection result or Text entry		
				Decimal point	+1.0000, +10.000, +100.00, +1000.0, +10000.0		
Rated output	Numerical entry						
Calibration coefficient		μV/V, mV/V, μST(1x10 ⁻⁶ Strain)					
(11)-2	Auto balance adjustment		▷ Execute				
(11)-3	Auto balance adjustment (unit)		▷ Execute				
(11)-4	Auto balance adjustment (all units)		▷ Execute				

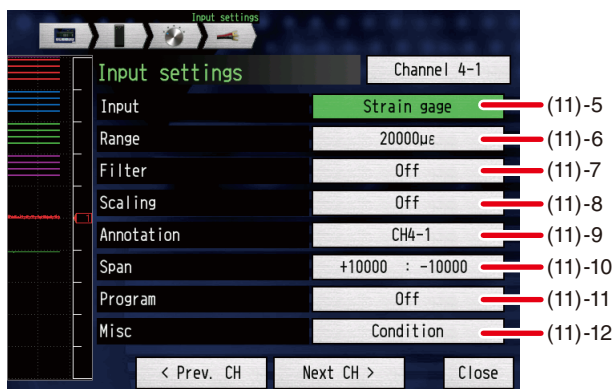

<Example : Other settings>

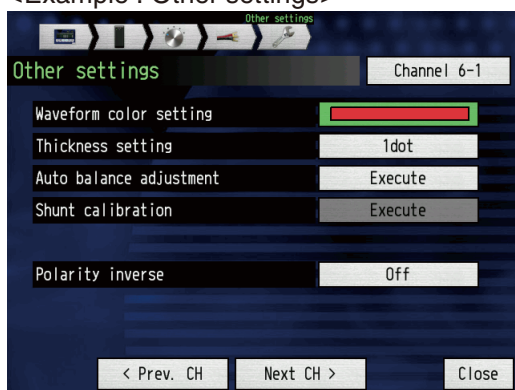

Item select		Examples of item				
(11)-5	Input	Input		Off, Strain gauge, Strain sensor, Voltage, Resistance		
		Strain gage *1	Bridge type		Quarter bridge, Half bridge, Full bridge	
			Number of wires		2-wire, 3-wire, 4-wire, 5-wire, 6-wire	
			Gauge resistor	Quarter bridge, Half bridge	120 Ω, 350 Ω	
				Full bridge	Numerical entry	
			Sensor setting		Refer to (11)-1.	
		Strain sensor *2	Number of wires		4-wire, 6-wire	
			Bridge resistor		Numerical entry	
			Sensor setting		Refer to (11)-1.	
			TEDS setting *3	Read TEDS information	▷ Load	
				Release TEDS information	▷ Release	
				TEDS Save information	File name	Text entry
					Naming method	Auto, Arbitrary, Sequential number
		Save	▷ Execute			
TEDS Read information	File name	File selection				
	Load	▷ Execute				
Voltage		–				
Resistance		–				

Item select				Examples of item		
(11)-6	Range	Strain gauge / Strain sensor	Strain unit	μ	400, 500, 800, 1000, 2000, 4000, 5000, 8000, 10000, 20000 μ ($\mu : 10^{-6}$ strain) * Range varies with bridge voltage.	
					mV/V	0.2, 0.25, 0.4, 0.5, 1, 2, 2.5, 4, 5, 10 mV/V
		Voltage				1, 2, 5, 10, 20, 50, 100, 200, 500 mV; 1, 2, 5 V
		Resistor *4				1, 2, 5, 10, 20, 50, 100, 200, 500 Ω ; 1, 2, 5, 10, 20, 50 k Ω
(11)-7	Filter	L.P.F		Off, Line (1.5Hz), 3, 6, 10, 30, 50, 60, 100, 300, 500 Hz; 1, 3, 5, 10 kHz, Auto (A.A.F)		
(11)-8	Scaling	Scaling			Off / On	
		Measured value	Upper level		Numerical entry	
			Lower level		Numerical entry	
		Output value	Upper level		Numerical entry	
			Lower level		Numerical entry	
		Decimal point				Select decimal point value according to range.
		Unit selection				Voltage, Current, Length, Area, Volume, Speed, Acceleration, Frequency, Mass, Energy, Pressure, Flow rate, Temperature, Strain, Brightness, Concentration, Arbitrary
Unit				Above unit selection result or Text entry		
(11)-9	Annotation			Text entry (Up to 31 characters)		
(11)-10	Span setting	Upper level		Numerical entry		
		Lower level		Numerical entry		
(11)-11	Inter-CH operation	Inter-CH operation			Of / On	
		Operation			CH-X (Function) CH-Y CH-X: CH1 to CH112 Function: Four arithmetic operations (+, -, \times , \div) CH-Y: CH1 to CH112	
		Scaling			/1000000, /1000, $\times 1$, $\times 1000$, $\times 1000000$	
		Operations span	Upper level		Numerical entry	
			Lower level		Numerical entry	
		Decimal point				Select decimal point value according to range.
		Unit selection				Voltage, Current, Length, Area, Volume, Speed, Acceleration, Frequency, Mass, Energy, Pressure, Flow rate, Temperature, Strain, Brightness, Concentration, Arbitrary
Unit				Above unit selection result or Text entry		
(11)-12	Misc	Common	Waveform color setting		Red, Green, Blue (RGB) each color 0 to 31	
			Thickness setting		1 to 8 dots	
		Strain gage/ Strain sesnor	Auto balance adjustment		\triangleright Execute	
			Shunt calibration *5		\triangleright Execute	
			Polarity inverse		Off / On	
		Voltage / Resistor	Auto zero adjustment		\triangleright Execute	
Zero adjustment reset			\triangleright Reset			

* For the supplement description of the mark (*), refer to the below.

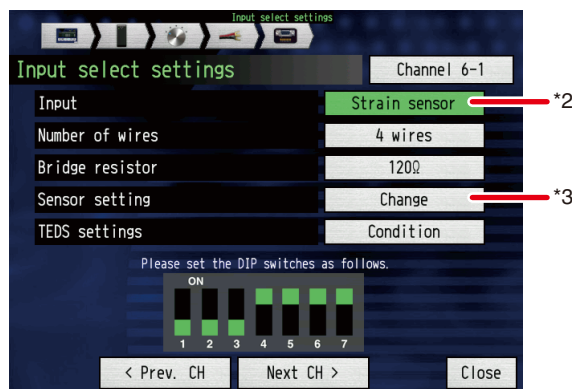
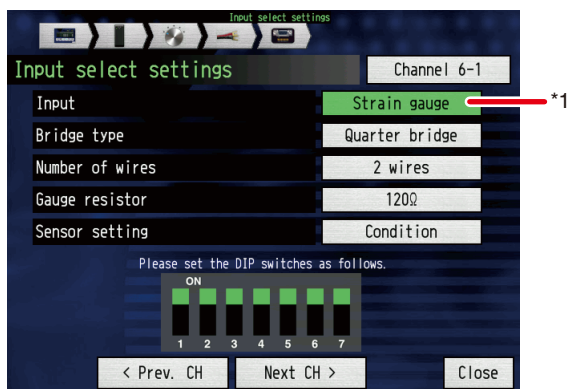

***1: How to use the DC strain module**

The section explains how to connect the DC strain module.

<Setting procedure>

- Refer to "Chapter 2 Confirmation and preparation of the DC strain module" to wire between the DC strain module and input terminals.
- Select the DC strain module in the Input select settings of the Input Selecting screen.
- Select one of Quarter bridge, Half bridge or Full bridge as Bridge type.
- Next, select Number of wires. Number of wires depends on the Bridge type. Number of wires should be set depending on the type.
- Select the either 120Ω or 350Ω as Gauge resistor when Quarter bridge or Half bridge is used.
- When the Full bridge is used, enter the value.
- From Misc in the input settings menu (11)-5, select the bridge voltage in the sensor settings.

⚠ WARNING

The bridge voltage 5V and 10V only should be used for the 350Ω gauge resistor. When the 350Ω gauge resistor is set, the module or gauge may be damaged.

⚠ CAUTION

When using Full bridge, the resistance value is limited depending on the settings of bridge voltage.

[Strain gauge]

Setting range of the gauge resistor

	Bridge voltage	Bridge current	Gauge type			
			Full bridge		Half bridge	Quarter bridge
			Max.	Max.		
Gauge resistor	1 V	Voltage	10000 Ω	50 Ω	120 or 350 Ω	
		Current		50 Ω		
	2 V	Voltage	95 Ω			
		Current	100 Ω			
	2.5 V	Voltage	114 Ω			
		Current	120 Ω			
	5 V	Voltage	330 Ω			
		Current	250 Ω			
10 V	Voltage	330 Ω				
	Current	500 Ω				

- Set the DIP switch on the module to the settings as shown at the bottom of the screen.
- The strain gauge can be set in the settings above. Simultaneously set the Range, Filter, Scaling, etc for the measurement.

- Before starting the measurement, perform the zero point adjustment by pressing the auto balance adjustment in Misc or the auto balance switch on the module.

* When performing the shunt calibration to correct the error in the strain gauge, refer to *5 Shunt calibration described below.

As well, if you do not know how to use remote sensing to correct the lead wire resistance, refer to the descriptions of the strain and bridge circuit configuration in Chapter 2 Confirmation and preparation of the DC strain module, and *5 Table listed the settable items.

*2: How to use the DC strain module

The section explains how to connect the acceleration sensor and load cell, etc. to be used.

<Setting procedure>

- For how to connect the strain sensor, refer to Chapter 2 Confirmation and preparation of the DC strain module.
- Select the strain sensor in the Input select settings of the Input Selecting screen.
- Select the either 4 wires or 6 wires as Number of wires of the DC strain module.
- Enter the value of the bridge resistor in the DC strain module.
- Select the bridge voltage in the sensor setting screen of the Other setting screen.

WARNING

The bridge voltage 5V and 10V only should be used for the 350Ω gauge resistor. When the 350Ω gauge resistor is set the module or gauge may be damaged.

The resistance values that can be entered according to the bridge voltage setting are as shown in the table below.

[Strain sensor]

Setting range of the Bridge resistor

	Bridge voltage	Bridge current	Max.	Min.
Bridge resistor	1 V	Voltage	10000 Ω	50 Ω
		Current		50 Ω
	2 V	Voltage		95 Ω
		Current		100 Ω
	2.5 V	Voltage		114 Ω
		Current		120 Ω
	5 V	Voltage		330 Ω
		Current		250 Ω
	10 V	Voltage		330 Ω
		Current		500 Ω

- Enter a numerical value of the rated capacity of the strain sensor to be used.
- Enter a numerical value of the rated output or calibration coefficient of the strain sensor to be used.
- The strain sensor can be set in the settings above. Simultaneously set the Range, Filter, Scaling, etc. for the measurement.
- Before starting the measurement, set the initial value to 0 (zero) by performing the auto balance adjustment in the Misc or pressing the auto-balancing switch on the module.

* Refer to *3 below, when the sensor with TEDS function is used.

*3: The section explains how to use the sensor with TEDS function.

When the TEDS-compatible sensor is used, the information of rating capacity, rated output and unit are automatically read in the module.

The TEDS function of this module complies with IEEE1451.4 standard template No.33 (Strain sensor). TEDS function can be set in "Input select settings" or "Misc".

<Setting procedure>

- The strain sensor is connected using the DSUB-NDIS conversion cable (B-561) supplied. (Only the cable sold in Japan) One DSUB-NDIS conversion cable only is supplied. If not enough, please buy the optional accessories separately.
When the other connector not manufactured by Tajimi is used, connect a DSUB connector or via a DSUB-Screw terminals conversion connector.
- In TEDS settings in the screen, get the "Read TEDS information".
Perform various settings of this module of strain sensor in this setting.
- Set the Range, Filter and Scaling, etc. depending on the measurement conditions after getting it.
- Set the DIP switch as the settings of DIP switch displayed at the bottom of the Input Select Setting screen.
- The connection settings are completed.

⚠ CAUTION

Since the NDIS connector has no remote sensing terminals, if the wiring between this module and the strain sensor is longer, the accuracy may be adversely affected.

***4: Resistance range provides the following functions.**

When the resistance range is set, the exciting current is automatically set the current value as shown the table below.

Range	Exciting current
1Ω	10 mA
2Ω	
5Ω	
10Ω	
20Ω	
50Ω	1 mA
100Ω	
200Ω	
500Ω	
1kΩ	
2kΩ	0.1 mA
5kΩ	
10kΩ	
20kΩ	
50kΩ	

***5: Shunt calibration:**

When the shunt resistor (approx. 60kΩ: at 120Ω, approx. 175kΩ: at 350Ω) built in this module and the strain gauge to be used are connected in parallel, the error in the measurement range is reduced by correcting (calibrating) automatically. Therefore, the measurement accuracy will be enhanced.

<Setting procedure>

- Connect the strain gauge depending on the application.
- In Input select settings on the screen, arrange the Bridge type, Number of wires, and Gauge resistor in the input items.
- Set the DIP switch as the settings of DIP switch displayed at the bottom of the Input Select Setting screen.
- Perform the shunt calibration of setting items in Misc.
Calibration is completed.
- Before starting the measurement, make sure to perform the zero point correction by pressing the auto-balancing in Misc or the module.

CAUTION

- When the measurement conditions are changed, make sure to perform the shunt calibration again.
- When the power cycle is performed, the setting values are initialized. For this reason, make sure to perform the shunt calibration again.
- The following table shows the possible settings for the remote sensing and shunt calibration.

Input	Bridge type	Number of wires	Remote sensing	Shunt calibration
Strain gauge	Quarter bridge	2 wires	Disable	Disable
		3 wires	Enable	Enable
		4 wires	Enable	Enable
	Half bridge	3 wires	Disable	Disable
		4 wires	Enable	Disable
		5 wires	Enable	Enable
	Full bridge	4 wires	Disable	Disable
6 wires		Enable	Disable	
Strain sensor	without remote sensing	4 wires	Disable	Disable
	with remote sensing	6 wires	Enable	Disable

CHECKPOINT

There are the following methods in order to improve the measurement precision of the strain gauge and strain gauge-type conversion sensor.

1. Gauge factor correction

In the strain gauge measurement with the GL7-DCB (DC strain module), the strain is calculated as gauge factor 2.0.

If the gauge factor of the strain gauge used to measure is not 2.0, the true strain can be calculated using the following equation.

$$\text{True strain ()} = \frac{2.00}{\text{Gauge factor (Ks)}} \times \text{Measured strain ()}$$

2. How to measure depending on the changes in environmental temperature at the measurement.

(1) In addition to the strain caused by external force, the apparent strain is caused by the linear expansion coefficients of the material of the object to be measured by a temperature change and the strain gauge (Resistive element). When the self-temperature-compensated gauge to correct the linear expansion coefficient of the object to be measured is used, the influence of apparent strain caused by the difference in the linear expansion coefficient is eliminated.

(2) If the distribution cable is longer or the measurement environment temperature significantly changes, the resistance change caused by the change of the cable conductor resistance is measured as the apparent strain. There are the following two methods to eliminate the effects of the error.

(2)-1. Remote sensing function (Use of remote sensing terminals)

With the remote sensing function, the change of the cable conductor resistance that causes the error can be prevented.

When the strain gauge measurement with Quarter bridge, Half bridge or Full bridge is used, or the remote sensing terminals are additionally wired for the strain transducer sensor, the voltage drop caused by the cable conductor resistance from the module to the object to be measured can be prevented and the regulated voltage is applied.

(2)-2. Use of the constant-current system

When the remote sensing function is not available because that additional cable wiring is difficult for the measurement with the strain transducer sensor, select the constant-current system. Enter the value of the input resistance (R) of the strain transducer sensor bridge circuit and select one of 1, 2, 2.5, 5 or 10V as the exciting voltage (E) of the bridge circuit. As a result, you can control the constant current to generate a regulated voltage that satisfies the following equation.

Exciting voltage (E) of the bridge circuit = Input resistance (R) of the bridge circuit x Constant current (I)

Therefore, when the constant-current system is selected, the voltage drop caused by the cable conductor resistance can be prevented and the regulated voltage is supplied to the strain transducer sensor.

<Charge Module (GL7-CHA)>

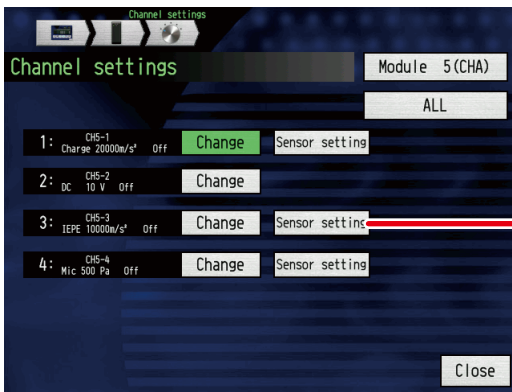

(11)-1

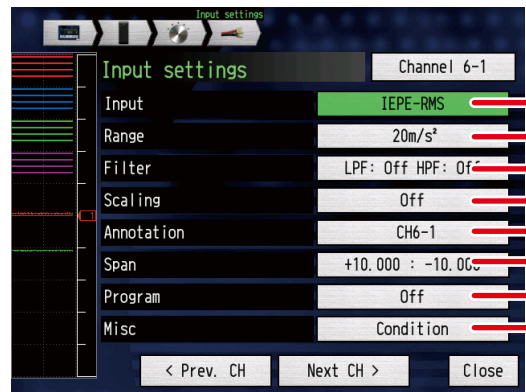

- (11)-2
- (11)-3
- (11)-4
- (11)-5
- (11)-6
- (11)-7
- (11)-8
- (11)-9

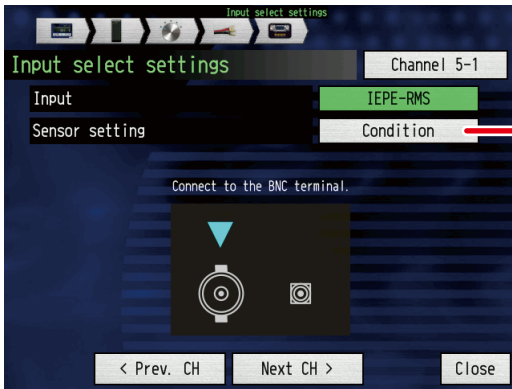

(11)-1

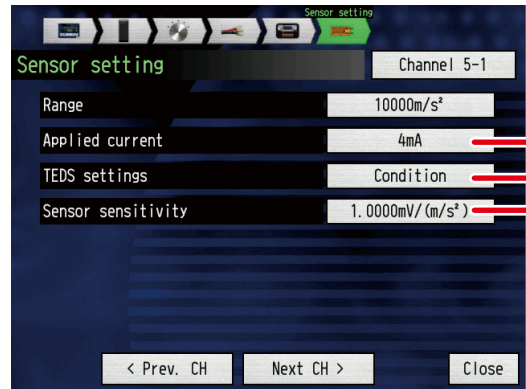

- *4
- *5
- *6

<Example : Other settings>

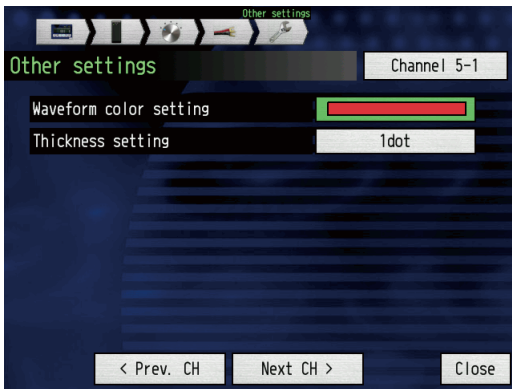

Item select			Examples of selection		
(11)-1	Sensor setting	Common	Range	Refer to (11)-3.	
		IEPE/IEPE-RMS *7	Applied current *5	4, 8 mA	
			TEDS setting *6	Read TEDS information	▷ Load
				Release TEDS information	▷ Release
			TEDS Save information	File name	Text entry
				Naming method	Auto, Arbitrary, Sequential number
				Save	▷ Execute
			TEDS Read information	File name	File selection
				Load	▷ Execute
			Sensor sensitivit *1		Numerical entry (Numeric value of sensors used)
			Charge/ Charge-RMS	Sensor sensitivit *1	Numerical entry (Numeric value of sensors used)
		Microphone	Applied current *5	4 mA fixed	
			TEDS setting *6	Read TEDS information	▷ Load
				Release TEDS information	▷ Release
			TEDS Save information	File name	Text entry
				Naming method	Auto, Arbitrary, Sequential number
				Save	▷ Execute
			TEDS Read information	File name	File selection
				Load	▷ Execute
			Microphone sensitivity	Sensitivity input	Numerical entry
Unit selection	dB re. 1 V/Pa / mV/Pa				
Preamplifier loss		Numerical entry			
(11)-2	Input	Off, Charge, IEPE, Microphone, DC, AC, Charge-RMS, IEPE-RMS, DC -RMS, AC-RMS			
(11)-3	Range	Charge *8	5, 10, 20, 50, 100, 200, 500, 1000, 2000, 5000, 10000, 20000, 50000m/s ²		
		IEPE *7	1, 2, 5, 10, 20, 50, 100, 200, 500, 1000, 2000, 5000, 10000, 20000, 50000m/s ²		
		Microphone *7	200, 400, 500mPa, 1, 2, 4, 5, 10, 20, 40, 50, 100, 200, 400, 500Pa		
		DC	50, 100, 200, 500mV, 1, 2, 5, 10V		
		AC	50, 100, 200, 500mV, 1, 2, 5, 10V		
		Charge-RMS *1 *8	5, 10, 20, 50, 100, 200, 500, 1000, 2000, 5000, 10000, 20000, 50000m/s ²		
		IEPE-RMS *1 *7	1, 2, 5, 10, 20, 50, 100, 200, 500, 1000, 2000, 5000, 10000, 20000, 50000m/s ²		
		DC-RMS *1	20, 50, 100, 200, 500mV, 1, 2, 5V		
		AC-RMS *1	20, 50, 100, 200, 500mV, 1, 2, 5V		
(11)-4	Filter	L. P. F *2	Off, Line (1.5Hz), 3, 6, 10, 30, 50, 60, 100, 300, 500Hz, 1, 3, 5, 10kHz, Automatic (A.A.F)		
		H. P. F *3 *7 *8	Off, 0.15, 1, 10Hz		

Item select			Examples of selection	
(11)-5	Scaling	Scaling	Off, On	
		Meas. Value	Upper limit value	Numerical entry
			Lower limit value	Numerical entry
		Output Value	Upper limit value	Numerical entry
			Lower limit value	Numerical entry
		Decimal point		Select the decimal point value depending on the range.
		Unit selection	Sorting	Voltage, Current, Length, Area, Volume, Speed, Acceleration, Frequency, Weight, Work, Pressure, Flow rate, Temperature, Strain, Brightness, Concentration, Arbitrary
			Unit selection	(Selected items vary depend on the group above.)
Unit		Text entry		
Integral *4		Acceleration, velocity, displacement		
(11)-6	Annotation		Text entry (Max. 31 characters)	
(11)-7	Span	Upper limit value	Numerical entry	
		Lower limit value	Numerical entry	
(11)-8	Program	Program	Off, On	
		Arithmetic expression		CH-X (Function) CH-Y CH-X: CH1 to CH12 Function: four arithmetic operations (+, -, x, ÷) CH-Y: CH1 to CH12
		Scaling		/1000000, /1000, x1, x1000, x1000000
		Calculation span	Upper limit value	Numerical entry
			Lower limit value	Numerical entry
			Decimal point	Select the decimal point value depending on the range.
		Unit selection	Sorting	Voltage, Current, Length, Area, Volume, Speed, Acceleration, Frequency, Mass, Energy, Pressure, Flow rate, Temperature, Strain, Brightness, Concentration, Arbitrary
			Unit selection	(Selected items vary depend on the group above.)
Unit		Text entry		
(11)-9	Misc	DC, AC, DC-RMS, AC-RMS, IEPE, IEPE-RMSS, Charge, Charge-RMS	Waveform color settings	Red, Green, Blue (RGB) Each color: 0 to 31
			Thickness settings	1 to 8 dots
			Automatic zero point adjustment	▷ Execute
			Zero point adjustment reset	▷ Execute

*1: Range: Within 2Vrms range; Crest Factor 4 or less, 5Vrms range; Crest Factor 2 or less

*2: Filter: A. A. F. (Anti-aliasing filter) is automatically set to 1/2.5 of the sampling frequency.
Also, A.A.F. and L.P.F. can not be used together.

*3: When the input coupling is AC or AC-RMS and "AC" is displayed, H. P. F is not available.

*4: Integral: The output of the acceleration sensor can be set to one of Acceleration, Velocity or Displacement.



- When the Integral is set to Velocity or Displacement, the scaling value is automatically set. The scaling value is not allowed to change.
- The velocity can be converted within the range of 10 to 200 Hz.
- The displacement can be converted within the range of 10 to 70 Hz.
- When setting to Charge-RMS or IEPE-RMS, the integral function cannot be used.

*5: Applied current: This is used for the range settings of IEPE/IEPE-RMS.

*6: TEDS settings: When the TEDS-compatible sensor is used, the information of the rated capacity and rated output is automatically read in this module.
The TEDS function of this module is compliant with IEEE 1451.4 standard template No. 25 (acceleration sensor) and No. 27 (microphone).
For the settings, refer to the following setting procedure.

*7: For IEPE and microphone, 1 Hz and 10 Hz can be selected for H.P.F.

*8: If the zero point is shifted by the charge-type sensor, insert H.P.F as necessary.

<Setting procedure of TEDS-compatible sensor >

- Connect the acceleration sensor with built-in amplifier to the BNC terminal.
- In Input Select settings on the screen, match the input value to the range of Built-in amplifier or Built-in amplifier-RMS.
- In TEDS settings in the screen, perform the Read TEDS information.
Various settings of this module connected the acceleration sensor are completed in this setting.
- The acceleration sensor can be set using the setting procedure above. Set the range modification, filter and scaling, etc. in accordance with the measurement conditions.

The connection settings are completed.

How to use the acceleration sensor

This section explains how to connect the acceleration sensor with built-in preamplifier.

<Setting procedure>

- Set the input items of the IEPE or IEPE-RMS.
- Set "Sensor setting Sensor sensitivity" according to the sensor specifications to be used.
- Set the Range.
Refer to the range setting table [IEPE/IEPE-RMS Input]. Selection of the voltage sensitivity varies depending on the range.
- Charge module is used as a unit. Therefore, set depending on "Integral in Scaling" when processing either the Velocity or Displacement.
- The acceleration sensor can be set in the settings above. Simultaneously set the Range, Filter, Scaling, etc for the measurement.

This section explains how to connect the charge-type acceleration sensor.

⚠ WARNING

When other than the sensor with built-in amplifier is set, do not change the input setting to Built-in amplifier, Built-in amplifier-RMS. This may damage the modules and the object to be measured.

<Setting procedure>

- Set the input items of the Charge or Charge-RMS.
- Set "Sensor setting Sensor sensitivity" according to the sensor specifications to be used.
- Set the Range.
Refer to the range setting table [Charge/Charge-RMS Input]. Selection of the charge sensitivity varies depending on the range.
- When the velocity or displacement is processed for the acceleration sensor, set the processing method in "Scaling Integral".
- When processing either the Velocity or Displacement for the acceleration sensor to be used, set the processing method depending on "Integral in Scaling".

(11)-2-1 Input

Selects the input conditions

<Voltage module>, <High-speed voltage module>

Item select	Description
Off	Does not measure the input signal. Waveform, digital display also not carried out.
DC	For use when measuring input signal.

<Voltage/Temperature module>

Item select	Description
Off	Does not measure the input signal. Waveform, digital display also not carried out.
DC	For use when measuring voltage.
TEMP	For use when measuring the temperature.
Humidity	For use when using a B-530 humidity sensor to measure the humidity. In this case, the voltage range is set to 1V, and EU settings cannot be set.

<Logic/Pulse module>

Item select	Description
Off	Does not measure the input signal. Waveform, digital display also not carried out.
Revolve	Counts the number of pulses for each sample interval, and converts it to the rotation rate per minute.
Counts	The pulse of each sample interval is calculated from the measurement start and is recorded.
Instant	Records the number of pulses of each sample interval.

* Can be selected when set to pulse amplifier.

CHECKPOINT

- When sampling rate is external, rotation rate can not be changed, and will become an instantaneous value. However the units will become RPM.
- When using a pulse, it will be at 0 at first. When start trigger is off, the first point of data is 0.

<High voltage module>

Item select	Description
Off	Does not measure the input signal. Waveform, digital display also not carried out.
DC	The input signal is measured with DC coupling.
AC	The input signal is measured with AC coupling.
DC-RMS	The input signal is measured with DC coupling. The measured value is an effective value.
AC-RMS	The input signal is measured with AC coupling. The measured value is an effective value.

<DC strain module>

Item select	Description
Off	The input signal is not measured. The waveforms and digital values are not displayed.
Strain gauge	This is used for Quarter bridge, Half bridge or Full bridge.
Strain gauge sensor	The sensor for Full bridge 4 wires and 6 wires is used to measure.
Voltage	This is used to measure the DC voltage.
Resistance	1Ω to 50kΩ resistance is measured.

<Charge module>

Item select	Description
Off	The input signal is not measured. The waveforms and digital values are not displayed.
Charge	The acceleration sensor signal that conforms to the IEPE specification is measured. The measured value is an effective value.
IEPE	The acceleration sensor signal that conforms to the IEPE specification is measured.
Microphone	Measure the signal from the microphone.
DC	The input signal is measured with DC coupling.
AC	The input signal is measured with AC coupling.
Charge-RMS	The acceleration sensor signal that conforms to the charge specification is measured. The measured value is an effective value.
IEPE-RMS	The acceleration sensor signal that conforms to the charge specification is measured.
DC-RMS	The input signal is measured with DC coupling. The measured value is an effective value.
AC-RMS	The input signal is measured with AC coupling. The measured value is an effective value.

(11)-2-2 Slope (Slope of the pulse)

Set the pulse count slope (direction) when setting the pulse on a Logic/Pulse module.

Item select	Description
L	Counts the falling edges of the pulse.
H	Counts the rising edges of the pulse.

(11)-2-3 Number of pulses per revolution

When the input pulse is specified as the number of revolutions, set the number of pulses per revolution. As the number of pulses per revolution set here is 1 revolution, calculate the number of revolutions per minute (RPM).

For example, if "100" is set, 1 rotation is judged when 100 pulses have been input.

<Formula>

Rotation (rpm) = Pulse input frequency ÷ Number of pulses per revolution × 60 (1min.)

<Ex.>

Number of pulses per revolution: 100 (1 rotation is judged when 100 pulses have been input.)

Pulse entry : 1000 Hz (1000 pulses per sec.)

Number of revolutions : 600 RPM (600 revolutions per minute)

(11)-3 Range

Select the measurement range. The selectable contents changes according to the entry settings explained in the previous item (11)-1. Cannot be used when input is set to off.

<Voltage module>, <High-speed voltage module >

Input settings	Selection
Voltage	100 to 200/500mV, 1/2/5/10/20/50/100V, 1-5V

Range	Max. span (Measurable range)	Min. span	Min. resolution
100 mV	-110.00 to +110.00 mV	1.00 mV	0.01 mV
200 mV	-220.00 to +220.00 mV	2.00 mV	0.01 mV
500 mV	-550.0 to +550.0 mV	5.0 mV	0.1 mV
1 V	-1.1000 to +1.1000 V	0.0100 V	0.0001 V
2 V	-2.2000 to +2.2000 V	0.0200 V	0.0001 V
5 V	-5.500 to +5.500 V	0.050 V	0.001 V
10 V	-11.000 to +11.000 V	0.100 V	0.001 V
20 V	-22.000 to +22.000 V	0.200 V	0.001 V
50 V	-55.00 to +55.00 V	0.50 V	0.01 V
100 V	-110.00 to +110.00 V	1.00 V	0.01 V

<Voltage/Temperature module>

Input settings	Selection
Voltage	20/50/100/200/500mV, 1/2/5/10/20/50V, 1-5V
Temperature	TC-K, TC-J, TC-T, TC-R, TC-E, TC-B, TC-S, TC-N, TC-C (TC-W), Pt100, JPT100, Pt1000
Humidity	No selection

<Voltage>

Range	Range max. span (Measurable range)	Min. span	Min. resolution
20 mV	-22.000 to +22.000 mV	0.200 mV	0.001 mV
50 mV	-55.00 to +55.00 mV	0.50 mV	0.01 mV
100 mV	-110.00 to +110.00 mV	1.00 mV	0.01 mV
200 mV	-220.00 to +220.00 mV	2.00 mV	0.01 mV
500 mV	-550.0 to +550.0 mV	5.0 mV	0.1 mV
1 V	-1.1000 to +1.1000 V	0.0100 V	0.0001 V
2 V	-2.2000 to +2.2000 V	0.0200 V	0.0001 V
5 V	-5.500 to +5.500 V	0.050 V	0.001 V
10 V	-11.000 to +11.000 V	0.100 V	0.001 V
20 V	-22.000 to +22.000 V	0.200 V	0.001 V
50 V	-55.00 to +55.00 V	0.50 V	0.01 V

<Temperature>

Range	Max. span	Min. span	Measurable range	Min. resolution
TC-K	-270 to +2000°C	50°C	-200 to +1370°C	0.1°C
TC-J			-200 to +1100°C	
TC-T			-200 to +400°C	
TC-R			0 to +1600°C	
TC-E			-200 to +800°C	
TC-B			+600 to +1820°C	
TC-S			0 to +1760°C	
TC-N			-200 to +1300°C	
TC-C (TC-W)			0 to +2000°C	
Pt100			-200 to +850°C	
JPt100			-200 to +500°C	
Pt1000			-200 to +500°C	

* Pt1000: Compliance with IEC 751

<Humidity>

Range	Max. span	Min. span (p-p)	Min. resolution
-	0 to +110%	1.0%	0.1%

<High-voltage module>

Input settings	Selection
DC	2, 5, 10, 20, 50, 100, 200, 500, 1000 V
AC	2, 5, 10, 20, 50, 100, 200, 500, 1000 V
DC-RMS	1, 2, 5, 10, 20, 50, 100, 200, 500 V rms
AC-RMS	1, 2, 5, 10, 20, 50, 100, 200, 500 V rms

* The unit used in this module is V (volt).

[DC, AC]

Range	Range max. span (Measurable range)	Min. span	Min. resolution
2 V	-2.2000 to +2.2000 V	0.0200 V	0.0001 V
5 V	-5.500 to +5.500 V	0.050 V	0.001 V
10 V	-11.000 to +11.000 V	0.100 V	0.001 V
20 V	-22.000 to +22.000 V	0.200 V	0.001 V
50 V	-55.00 to +55.00 V	0.50 V	0.01 V
100 V	-110.00 to +110.00 V	1.00 V	0.01 V
200 V	-220.00 to +220.00 V	2.00 V	0.01 V
500 V	-550.0 to +550.0 V	5.00 V	0.1 V
1 kV	-1.1000 to +1.1000 V	0.0100 kV	0.0001 kV

[DC-RMS, AC-RMS]

Range	Range max. span (Measurable range)	Min. span	Min. resolution
1 V rms	0 to +1.1000 V rms	0.0100 V rms	0.0001 V rms
2 V rms	0 to +2.2000 V rms	0.0200 V rms	0.0001 V rms
5 V rms	0 to +5.500 V rms	0.050 V rms	0.001 V rms
10 V rms	0 to +11.000 V rms	0.100 V rms	0.001 V rms
20 V rms	0 to +22.000 V rms	0.200 V rms	0.001 V rms
50 V rms	0 to +55.00 V rms	0.50 V rms	0.01 V rms
100 V rms	0 to +110.00 V rms	1.00 V rms	0.01 V rms
200 V rms	0 to +220.00 V rms	2.00 V rms	0.01 V rms
500 V rms	0 to +550.0 V rms	5.00 V rms	0.1 V rms

* The unit used in this module is V (volt).

<DC strain module (GL7-DCB)>**[Strain gauge/Strain sensor]**

Input settings	Selection
μ	400, 500, 800, 1000, 2000, 4000, 5000, 8000, 10000, 20000 μ
mV/V	0.2, 0.25, 0.4, 0.5, 1, 2, 2.5, 4, 5, 10 mV/V

The following table shows the span settings for the stain gauge.

	Range	Max. span	Min. span	Min. resolution
μ	400 μ	-440.0 to +440.0 μ	4.0 μ	0.1 μ
	500 μ	-550.0 to +550.0 μ	5.0 μ	0.1 μ
	800 μ	-880 to +880 μ	8.0 μ	0.1 μ
	1000 μ	-11000 to +11000 μ	10.0 μ	0.1 μ
	2000 μ	-2200.0 to +2200.0 μ	20.0 μ	0.1 μ
	4000 μ	-4400.0 to +4400.0 μ	40.0 μ	0.1 μ
	5000 μ	-5500.0 to +5500.0 μ	50.0 μ	0.1 μ
	8000 μ	-8800.0 to +8800.0 μ	80.0 μ	0.1 μ
	10000 μ	-11000 to +11000 μ	100 μ	1 μ
	20000 μ	-22000 to +22000 μ	200 μ	1 μ
mV/V	0.2 mV/V	-0.2200 to +0.2200 mV/V	0.002 mV/V	0.0001 mV/V
	0.25 mV/V	-0.2750 to +0.2750 mV/V	0.003 mV/V	0.0001 mV/V
	0.4 mV/V	-0.4400 to +0.4400 mV/V	0.004 mV/V	0.0001 mV/V
	0.5 mV/V	-0.5500 to +0.5500 mV/V	0.005 mV/V	0.0001 mV/V
	1 mV/V	-1.1000 to +1.1000 mV/V	0.010 mV/V	0.0001 mV/V
	2 mV/V	-2.2000 to +2.2000 mV/V	0.020 mV/V	0.0001 mV/V
	2.5 mV/V	-2.7500 to +2.7500 mV/V	0.025 mV/V	0.0001 mV/V
	4 mV/V	-4.4000 to +4.4000 mV/V	0.040 mV/V	0.0001 mV/V
	5 mV/V	-5.5000 to +5.5000 mV/V	0.050 mV/V	0.001 mV/V
	10 mV/V	-11.000 to +11.000 mV/V	0.100 mV/V	0.001 mV/V

For strain sensor, the range varies depending on rated capacity, rated output and calibration coefficient.

[Voltage]

Input settings	Selection
Voltage	1, 2, 5, 10, 20, 50, 100, 200, 500 mV. 1, 2, 5 V

Range		Max. span	Min. span	Min. resolution
Voltage	1 mV	-1.1000 to +1.1000 mV	0.010 mV	0.0001 mV
	2 mV	-2.2000 to +2.2000 mV	0.020 mV	0.0001 mV
	5 mV	-5.5000 to +5.5000 mV	0.050 mV	0.001 mV
	10 mV	-11.000 to +11.000 mV	0.100 mV	0.001 mV
	20 mV	-22.000 to +22.000 mV	0.200 mV	0.001 mV
	50 mV	-55.00 to +55.00 mV	0.50 mV	0.01 mV
	100 mV	-110.00 to +110.00 mV	1.00 mV	0.01 mV
	200 mV	-220.00 to +220.00 mV	2.00 mV	0.01 mV
	500 mV	-550.0 to +550.0 mV	5.0 mV	0.1 mV
	1 V	-1.1000 to +1.1000 V	0.0100 V	0.0001 V
	2 V	-2.2000 to +2.2000 V	0.0200 V	0.0001 V
	5 V	-5.500 to +5.500 V	0.050 V	0.001 V

[Resistance]

Input settings	Selection
Resistance	1, 2, 5, 10, 20, 25, 50, 100, 200, 500 Ω , 1, 2, 5, 10, 20, 50 k

Range	Range			Max. span	Min. span	Min. resolution
	Exciting current	10mA	1 mA			
1 Ω	●			-1.1000 to +1.1000 Ω	0.0100 Ω	0.0001 Ω
2 Ω	●			-2.2000 to +2.2000 Ω	0.0200 Ω	0.0001 Ω
5 Ω	●			-5.5000 to +5.500 Ω	0.050 Ω	0.001 Ω
10 Ω	●			-11.000 to +11.000 Ω	0.100 Ω	0.001 Ω
20 Ω	●			-22.000 to +22.000 Ω	0.200 Ω	0.001 Ω
500 Ω		●		-55.00 to +55.00 Ω	0.50 Ω	0.01 Ω
100 Ω		●		-110.00 to +110.00 Ω	1.00 Ω	0.01 Ω
200 Ω		●		-220.00 to +220.00 Ω	2.00 Ω	0.01 Ω
500 Ω		●		-550.0 to +550.0 Ω	5.0 Ω	0.1 Ω
1 k Ω		●		-1.1000 to +1.1000 k Ω	0.0100 Ω	0.0001 Ω
2 k Ω		●		-2.2000 to +2.2000 k Ω	0.0200 Ω	0.0001 Ω
5 k Ω		●		-5.500 to +5.500 k Ω	0.050 Ω	0.001 Ω
10 k Ω			●	-11.000 to +11.000 k Ω	0.100 Ω	0.001 Ω
20 k Ω			●	-22.000 to +22.000 k Ω	0.200 Ω	0.001 Ω
50 k Ω			●	-55.00 to +55.00 k Ω	0.50 Ω	0.01 Ω

<Charge module (GL7-CHA)>

[Voltage input]

Item select	Description
DC	50, 100, 200, 500 mV, 1, 2, 5, 10 V
AC	50, 100, 200, 500 mV, 1, 2, 5, 10 V
DC-RMS*	20, 50, 100, 200, 500 mV rms, 1, 2, 5 V rms
AC-RMS*	20, 50, 100, 200, 500 mV rms, 1, 2, 5 V rms

* The unit used in this module is V (volt).

<DC/AC>

Range	DC/AC	DC-RMS/AC-RMS	Max. span	Min. resolution
20 mV		●	-22.000 to +22.000 mV	0.001 mV
50 mV	●	●	-55.00 to +55.00 mV	0.01 mV
100 mV	●	●	-110.00 to +110.00 mV	0.01 mV
200 mV	●	●	-220.00 to +220.00 mV	0.01 mV
500 mV	●	●	-550.0 to +550.00 mV	0.1 mV
1 V	●	●	-1.1000 to +1.1000 V	0.0001 V
2 V	●	●	-2.2000 to +2.2000 V	0.0001 V
5 V	●	●	-5.500 to +5.500 V	0.001 V
10 V	●		-11.000 to +11.000 V	0.001 V

<DC-RMS/AC-RMS>

Range	Max. span	Min. span
20 mV rms	-22.00 to +22.00 mV rms	0.20 mV rms
50 mV rms	-55.00 to +55.00 mV rms	0.50 mV rms
100 mV rms	-110.00 to +110.00 mV rms	1.00 mV rms
200 mV rms	-220.00 to +220.00 mV rms	2.00 mV rms
500 mV rms	-550.0 to +550.0 mV rms	5.0 mV rms
1 V rms	-1.1000 to +1.1000 V rms	0.0100 V rms
2 V rms	-2.2000 to +2.2000 V rms	0.0200 V rms
5 V rms	-5.500 to +5.500 V rms	0.050 V rms

* The unit used in this module is V (volt).

[IEPE/IEPE-RMS/Charge/Charge-RMS]

Item select	Description
Charge	5, 10, 20, 50, 100, 200, 500, 1000, 2000, 5000, 10000, 20000, 50000 m/s ²
IEPE	1, 2, 5, 10, 20, 50, 100, 200, 500, 1000, 2000, 5000, 10000, 20000, 50000 m/s ²
Charge-RMS	5, 10, 20, 50, 100, 200, 500, 1000, 2000, 5000, 10000, 20000, 50000 m/s ²
IEPE-RMS	1, 2, 5, 10, 20, 50, 100, 200, 500, 1000, 2000, 5000, 10000, 20000, 50000 m/s ²

<IEPE/IEPE-RMS/Charge/Charge-RMS>

Range	IEPE/IEPE-RMS	Charge/Charge-RMS	Max. span	Min. resolution
1 m/s ²	●		-1.100 to +1.100 m/s ²	0.001 m/s ²
2 m/s ²	●		-2.200 to +2.200 m/s ²	0.001 m/s ²
5 m/s ²	●	●	-5.500 to +5.500 m/s ²	0.001 m/s ²
10 m/s ²	●	●	-11.000 to +11.000 m/s ²	0.001 m/s ²
20 m/s ²	●	●	-22.000 to +22.000 m/s ²	0.001 m/s ²
50 m/s ²	●	●	-55.000 to +55.000 m/s ²	0.01 m/s ²
100 m/s ²	●	●	-110.00 to +110.00 m/s ²	0.01 m/s ²
200 m/s ²	●	●	-220.00 to +220.00 m/s ²	0.01 m/s ²
500 m/s ²	●	●	-550.00 to +550.00 m/s ²	0.1 m/s ²
1000 m/s ²	●	●	-1100.0 to +1100.0 m/s ²	0.1 m/s ²
2000 m/s ²	●	●	-2200.0 to +2200.0 m/s ²	0.1 m/s ²
5000 m/s ²	●	●	-5500.0 to +5500.0 m/s ²	0.1 m/s ²
10000 m/s ²	●	●	-11000 to +11000 m/s ²	1 m/s ²
20000 m/s ²	●	●	-22000 to +22000 m/s ²	1 m/s ²
50000 m/s ²	●	●	-55000 to +55000 m/s ²	1 m/s ²

<IEPE/IEPE-RMS Input>

Settings of the range and voltage sensitivity

Input setting	Voltage sensitivity Range	Voltage sensitivity Unit: mV/ (m/s ²)														
		0.0100 to 0.0200	0.0201 to 0.0500	0.0501 to 0.2000	0.2001 to 0.5000	0.5001 to 1.000	1.0001 to 2.000	2.0001 to 5.0000	5.0001 to 10.0000	10.001 to 20.000	20.0001 to 50.0000	50.0001 to 100.0000	100.0001 to 200.0000	200.0001 to 500.0000	500.0001 to 999.9999	
IEPE/ IEPE- RMS	1 m/s ²												●	●	●	●
	2 m/s ²											●	●	●	●	●
	5 m/s ²									●	●	●	●	●	●	●
	10 m/s ²								●	●	●	●	●	●	●	●
	20 m/s ²							●	●	●	●	●	●	●		
	50 m/s ²					●	●	●	●	●	●	●	●			
	100 m/s ²					●	●	●	●	●	●	●				
	200 m/s ²				●	●	●	●	●	●	●					
	500 m/s ²			●	●	●	●	●	●	●						
	1000 m/s ²		●	●	●	●	●	●	●							
	2000 m/s ²		●	●	●	●	●	●								
	5000 m/s ²	●	●	●	●	●	●									
	10000 m/s ²	●	●	●	●	●										
	20000 m/s ²	●	●	●	●											
	50000 m/s ²	●	●	●												

<Charge/Charge-RMS Input>

Settings of the range and charge sensitivity

Input setting	Charge sensitivity Range	Charge sensitivity Unit: mV/ (m/s ²)									
		0.0100 to 0.5000	0.5001 to 2.0000	2.0001 to 5.0000	5.0001 to 10.0000	10.0001 to 20.0000	20.0001 to 50.0000	50.0001 to 100.0000	100.0001 to 200.0000	200.0001 to 500.0000	500.0001 to 999.9999
Charge Charge- RMS	1 m/s ²									●	●
	2 m/s ²									●	●
	5 m/s ²						●	●	●	●	
	10 m/s ²					●	●	●	●	●	
	20 m/s ²					●	●	●	●	●	
	50 m/s ²				●	●	●	●	●	●	
	100 m/s ²				●	●	●	●	●		
	200 m/s ²			●	●	●	●	●			
	500 m/s ²		●	●	●	●	●				
	1000 m/s ²	●	●	●	●	●					
	2000 m/s ²	●	●	●	●	●					
	5000 m/s ²	●	●	●	●						
	10000 m/s ²	●	●	●							
	20000 m/s ²	●	●								
	50000 m/s ²	●									

[Microphone]

Input setting	Selection
Microphone	200, 400, 500 mPa; 1, 2, 4, 5, 10, 20, 40, 50, 100, 200, 400, 500 Pa

<Microphone>

Range	Microphone	Maximum span	Usage range
200mPa	●	-220 to +220mPa	20mV
400mPa	●	-440 to +440mPa	20mV
500mPa	●	-550 to +550mPa	50mV
1Pa	●	-1.1 to +1.1Pa	20/50/100mV
2Pa	●	-2.2 to +2.2Pa	20/100/200mV
4Pa	●	-4.4 to +4.4Pa	20/200mV
5Pa	●	-5.5 to +5.5Pa	50m/0.1/0.5V
10Pa	●	-11.0 to +11.0Pa	20/50m/0.1/0.2/0.5/1V
20Pa	●	-22.0 to +22.0Pa	20m/0.1/0.2/1/2V
40Pa	●	-44.0 to +44.0Pa	20m/0.2/2V
50Pa	●	-55.0 to +55.0Pa	50m/0.1/0.5/1/5V
100Pa	●	-110 to +110Pa	50m/0.1/0.2/0.5/1/2/5/10V
200Pa	●	-220 to +220Pa	0.1/0.2/1/2/10V
400Pa	●	-440 to +440Pa	0.2V
500Pa	●	-550 to +550Pa	0.5/1/5/10V

<Microphone input>

Range and voltage sensitivity settings

Range	Voltage sensitivity Range (Approx.)	Voltage sensitivity								Unit mV/Pa
		0.2 to 0.5	0.5 to 1	1 to 2	2 to 5	5 to 10	10 to 20	20 to 50	50 to 100	
Microphone	200mPa									●
	400mPa								●	
	500mPa									●
	1Pa						●	●	●	●
	2Pa					●		●	●	●
	4Pa				●			●		
	5Pa					●	●			●
	10Pa			●	●	●	●	●	●	●
	20Pa		●			●	●		●	●
	40Pa	●				●			●	
	50Pa		●	●			●	●		●
	100Pa	●	●	●	●	●	●	●	●	●
	200Pa	●	●			●	●		●	
	400Pa	●								
500Pa		●	●			●	●			

(11)-4 Filter

Select a filter.

<Voltage module>

The voltage module filter is the analogue low-pass filter

Item select	Description
Off	Filter is not in use.
Line	Cutoff frequency is approximately 1.5 Hz.
5Hz	Cutoff frequency is approximately 5 Hz.
50Hz	Cutoff frequency is approximately 50 Hz.
500Hz	Cutoff frequency is approximately 500 Hz.

<Voltage/Temperature module>

The filter of the Voltage/Temperature module is the moving average below.

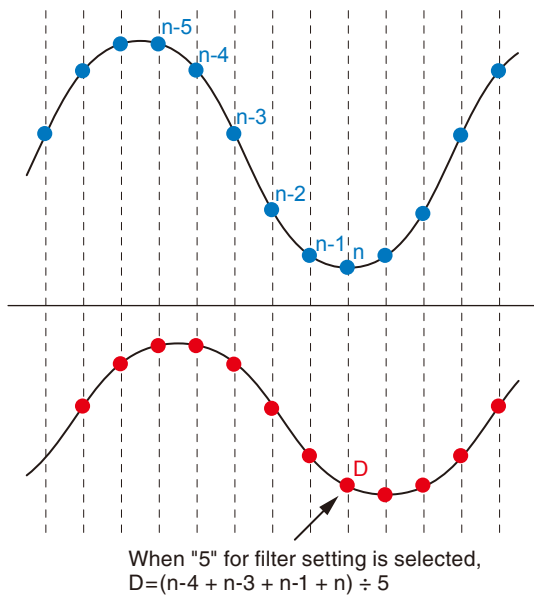

Item select	Description
Off	No moving average.
2	Sample interval: moving average 2 times
5	Sample interval: moving average 5 times
10	Sample interval: moving average 10 times
20	Sample interval: moving average 20 times
40	Sample interval: moving average 40 times

CHECKPOINT

If the sample interval is shorter than 10ms, the data will be the average value obtained during 10ms. Similarly, if the sample interval is longer than 5 seconds, the data will be the average value obtained during 5 seconds.

<High-speed voltage module/High-voltage module>

The high-speed voltage module and high voltage module filter is the low-pass filter on the analog circuit.

Item select	Description
Off	Filter is not in use.
Line	Cutoff frequency is approximately 1.5 Hz.
5 Hz	Cutoff frequency is approximately 5 Hz.
50 Hz	Cutoff frequency is approximately 50 Hz.
500 Hz	Cutoff frequency is approximately 500 Hz.
5 khz	Cut-off frequency is approx. 5 kHz.
50 kHz	Cut-off frequency is approx. 50 kHz.

<Logic/Pulse module>

The Logic/Pulse module filter is the low-pass filter on the analogue circuit.

Item select	Description
Off	Filter is not in use.
On	Cutoff frequency is approximately 50 Hz.

<DC strain module/Charge module>

The filter used in the DC strain module is a low-pass filter only.

Item select	Description
Off	Filter is not used.
Line	Cut-off frequency is approx. 1.5 Hz.
3 Hz	Cut-off frequency is approx. 3 Hz.
6 Hz	Cut-off frequency is approx. 6 Hz.
10 Hz	Cut-off frequency is approx. 10 Hz.
30 Hz	Cut-off frequency is approx. 30 Hz.
50 Hz	Cut-off frequency is approx. 50 Hz.
60 Hz	Cut-off frequency is approx. 60 Hz.
100 Hz	Cut-off frequency is approx. 100 Hz.
300 Hz	Cut-off frequency is approx. 300 Hz.
500 Hz	Cut-off frequency is approx. 500 Hz.
1 KHz	Cut-off frequency is approx. 1 kHz.
3 KHz	Cut-off frequency is approx. 3 kHz.
5 KHz	Cut-off frequency is approx. 5 kHz.
10 KHz	Cut-off frequency is approx. 10 kHz.
Automatic	A.A.F (Anti-aliasing filter) This filter is used to eliminate the aliasing errors that may occur during sampling, which automatically functions depending on the sampling.

<Charge module>

* High-pass filter is used in the charge module only.

Item select	Description
Off	Filter is not used.
0.15Hz	Cut-off frequency is approx. 0.15Hz.
1Hz	Cut-off frequency is approx. 1Hz.
10Hz	Cut-off frequency is approx. 10Hz.

(11)-5 EU (Scaling settings)

Unit changing the measurement signal.

<When the input is voltage>

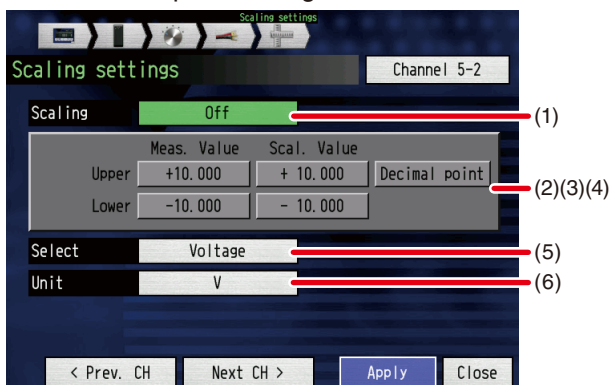

<When the input is temperature>

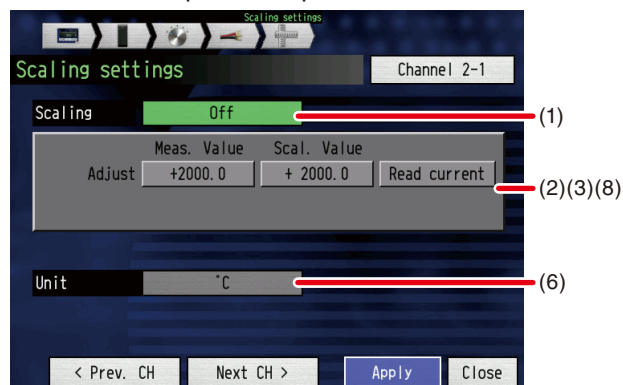

<When the input is pulse>

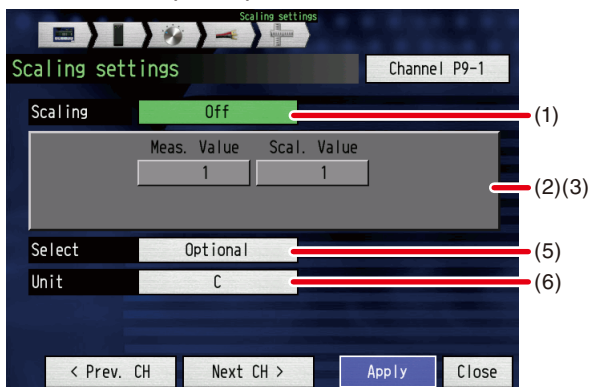

<When setting the Voltage and Charge for the charge Module>

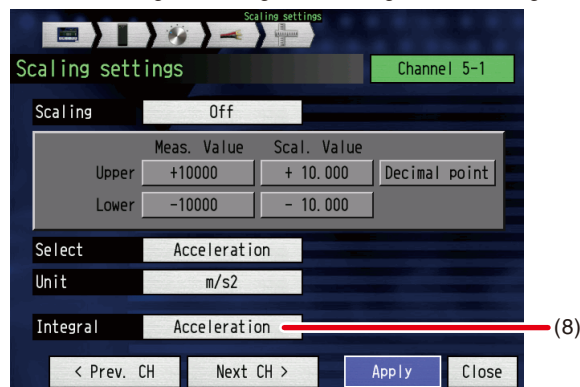

Item select	Examples of item
(1) Scaling	Select if the scaling function is ON/OFF.
(2) Meas. Value (Upper/Lower limit value)	Sets the upper limit value/lower limit value of the replacement source value. * If the input is temperature, there is no distinction between upper and lower limit values. For details, refer to set examples below.
(3) Scal. Value (Upper/Lower limit value)	Set the upper/lower limit value after changing. * If the input is temperature, there is no distinction between upper and lower limit value. For details, refer to set examples below.
(4) Decimal	Set the EU output value decimal position.
(5) Select	Voltage, Current, Length, Area, Volume, Speed, Acceleration, Frequency, Mass, Energy, Pressure, Flow rate, Temperature, Strain, Brightness, Concentration, Arbitrary
(6) Unit	The unit displayed here is the unit of classification selected in "Unit selection". When "Arbitrary" is selected in unit selection, you can enter any character string. (Up to 8 characters)
(7) Read current	Substitute the currently measured value in the measurement value (2) and the output value (3). * When the measured value is burned out or scaled over, the value can not be substituted. (When the temperature is used as the input)
(8) Integral	The output acceleration of the acceleration sensor is integrated and converted to the velocity and displacement.

CHECKPOINT

- If a message window is displayed, please follow the instructions in the window and change the measured values.
- The scaling function is calculated from the ratio of the measured values and output value. If it becomes a replacement value that cannot be processed by the GL7000 +++++/---- is shown on the digital display.
- Depending on the scaling setting contents, the span may change.
- If the input is temperature, its set to the input value offset setting.

Set example: When the input is voltage

	Measured values	EU output value	Decimal	Unit
Upper limit value	+5.000	+20.00	+xx.xx	rpm
Lower limit value	-5.000	-20.00		

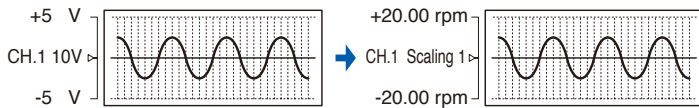

Set example: When the input is temperature

Measured values	EU output value
22.0°C	25.0°C

The set value is already 3°C plus.

Set example: When the input is pulse

Measured values	EU output value	Decimal	Unit
1000	800	+xx.xx	rpm

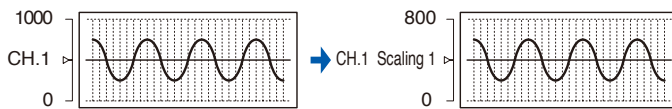

(11)-6 Annotation

Set the annotation(comment) to be displayed on the CH. The maximum number of characters of each string is 31.

Possible characters for input are alphanumeric characters and symbols.

(For details on entering characters, refer to "(2) Enter a character" on page 3-30)

(11)-7 Span

Set the upper and lower limit values for the waveform display span.

(11)-8 Inter-CH operation settings

Sets the contents for calculation between channels.

4 calculation rules (+, -, ×, ÷) can be set for calculation between channels.

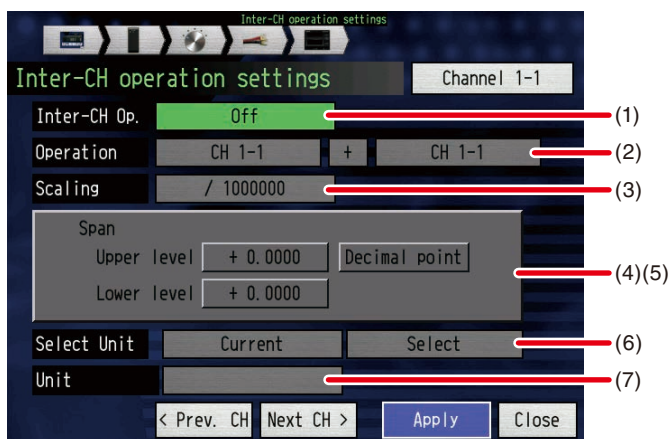

Item select		Examples of item
(1)	Inter-CH Op.	Select whether to use the Calculation between Channels function.
(2)	Operation	Set by the following equation. CH-X and CH-Y is set to analogue CH. CH-X(function) CH-Y
(3)	Scaling	/1000000, /1000, ×1, ×1000, ×1000000 Set the scaling factor for the calculated result <Ex.> Calculated result = 0.001 calculated result = 1000 ×1 : 0.001 ×1 : 1000 ×1000 : 1 /1000 : 1 ×1000000 : 1000 /1000000: 0.001
(4)	Upper level/Lower level	Set the upper and lower limit values for the waveform display span. The set value is the value of the calculated result.
(5)	Decimal point	Select the span settings decimal position.
(6)	Select Unit	Select the unit categories.
(7)	Unit	Select the unit after conversion. The unit displayed here is the unit of classification selected in "Unit selection". When "Arbitrary" is selected in unit selection, you can enter any character string. (Up to 8 characters)

CHECKPOINT

- The calculated result is displayed by the volt unit.
- By calculating 100mV+100mV, the calculated result is 0.2V. If you want to display 200mV, please use scaling.
- Calculating between Channels can be used when sampling rate is slower than 100ms.
- The result of the calculation is displayed on the channel you set the calculation.

(11)-9 Other settings

Set other contents.

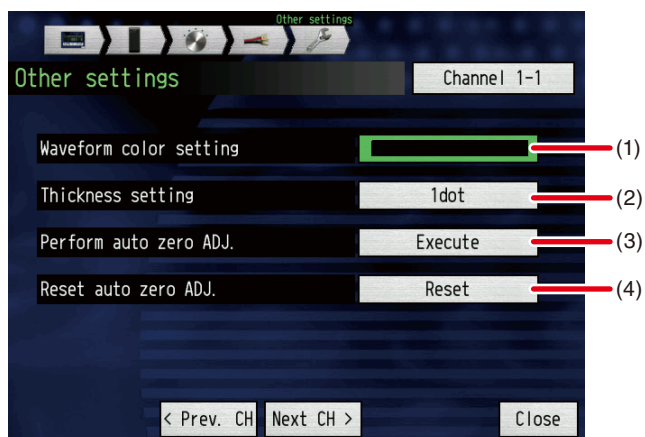

Item select		Description
(1)	Waveform color setting	Set the waveform color.
(2)	Thickness setting	Set the waveform line width.
(3)	Perform auto zero ADJ.	Calculates the current voltage input as the zero point voltage value. The possible automatic adjustment is inside $\pm 10\%$ of the set range of the voltage area. <Ex.> In case of 1V range, the possible adjustment area for input voltage is between -0.1V and +0.1V. If the input is temperature, this function cannot be used.
(4)	Reset auto zero ADJ.	Zero point adjustment reset.

(12) Trigger level settings

Set detailed settings of each channel when a trigger's start source, stop source is set to "Level Values". The level trigger is determined for each channel by the contents set here. The results are combined and the establishment (or lack thereof) for the whole trigger is decided (refer to the chart below).

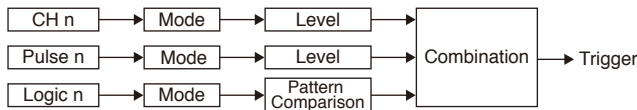

- Pulse and logic are changed with each module
- Combination settings for each module may be set to only one type. When the settings are changed, all modules are set to the same content. When settings are changed, all modules are set to the same content.

<When using Voltage, Voltage/Temperature, High-speed Voltage, High-voltage DC strain/Charge/Voltage Output module>

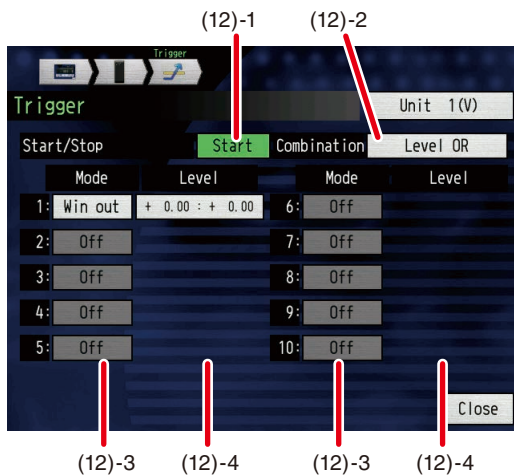

<In case of pulse with the Logic/Pulse module>

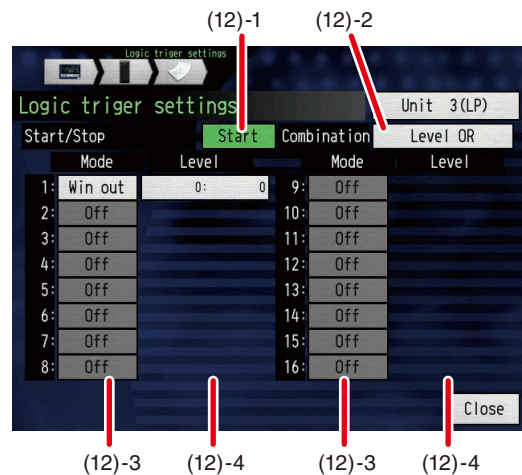

Item select		Examples of item	
(12)-1	Start/Stop	Start, Stop	
(12)-2	Combination	Level OR, Level AND, Edge OR, Edge AND	
(12)-3	Mode	Off, H, L, Win in, Win out	
(12)-4	H	Level	
	L	Level	
	Win in Win out	Upper level/ Lower level	Upper limit value Numerical entry

<In case of Logic with the Logic/Pulse module>

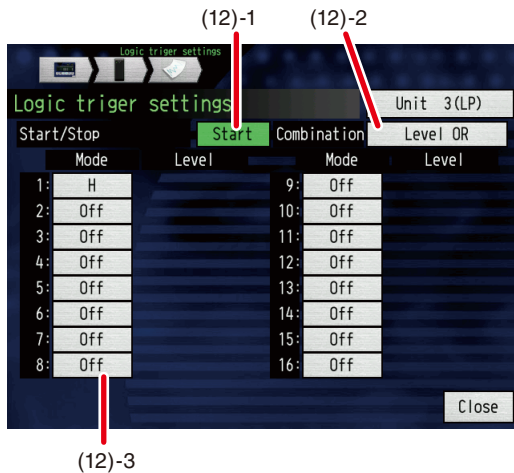

Item select		Examples of item	
(12)-1	Start/Stop	Start, Stop	
(12)-2	Combination	Level OR, Level AND, Edge OR, Edge AND	
(12)-3	Mode	When channel is set to Logic : Off, H, L, Win in, Win out	
		When channel is set to Pulse: Off, H, L, Win in, Win out	

(12)-1 Start/Stop

Selects settings related to the start side source or the stop side source.

(12)-2 Combination

Sets the combination of set trigger conditions for each channel.

Item select	Description
Level OR	If at least 1 of the set trigger conditions is satisfied, recording starts (stops). Each condition becomes a level action.
Level AND	If all of the set trigger conditions are satisfied, recording starts (stops). Each condition becomes a level action.
Edge OR	If at least 1 of the set trigger conditions is satisfied, recording starts (stops). Each condition becomes an edge action.
Edge AND	If all of the set trigger conditions are satisfied, recording starts (stops). Each condition becomes an edge action.

Level action and edge action

For level action, if the condition is satisfied when the "START" key is pressed, the trigger condition is considered satisfied.

For edge action, even if the condition is satisfied when the "START" key is pressed, it's not considered to be fulfilled. The condition can only be fulfilled by once the condition is once unfulfilled, and then once again satisfied.

* Once the Edge action is established, even should the condition cease to be fulfilled, it will still be considered satisfied.

<Ex.> Level action

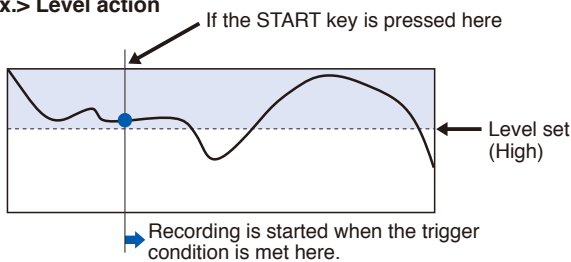

<Ex.> Edge action

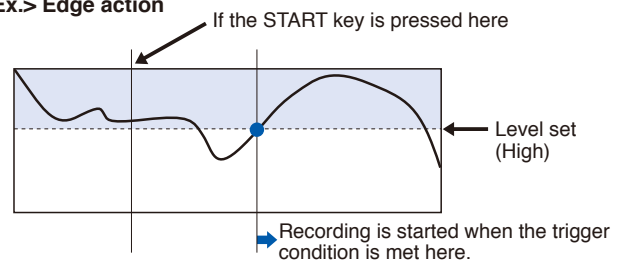

<Ex.> Level AND action

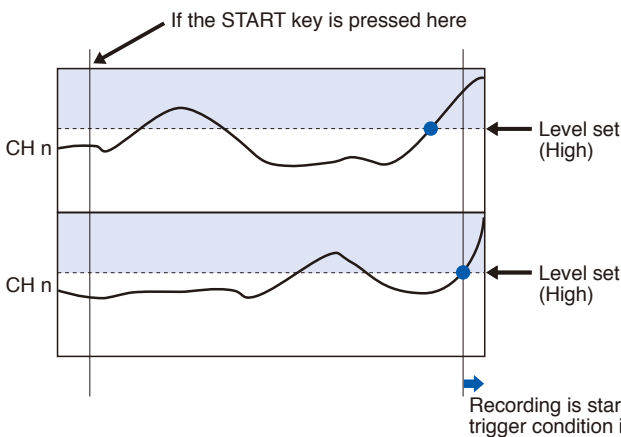

<Ex.> Edge AND action

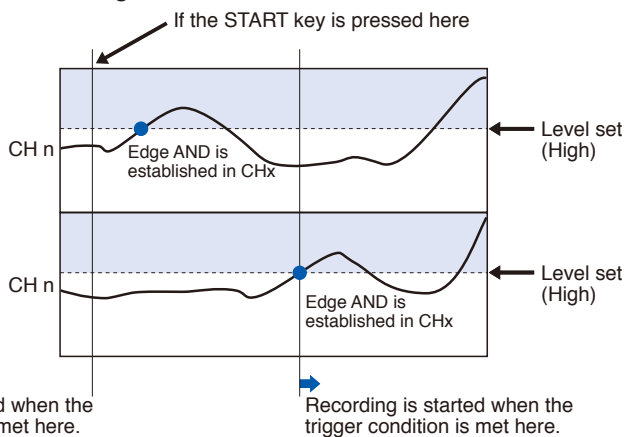

(12)-3 Mode

Set the trigger comparison mode for each channel.

High: Condition where a trigger/alarm occurs when the input signal exceeds a set level.

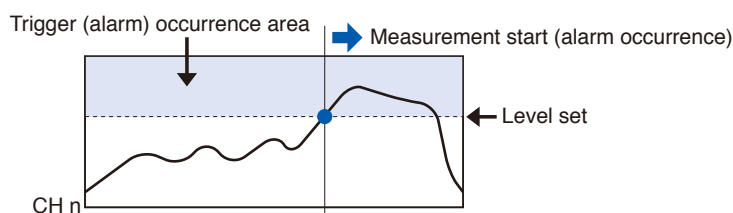

Low: Condition where a trigger/alarm occurs when the input signal exceeds a set level.

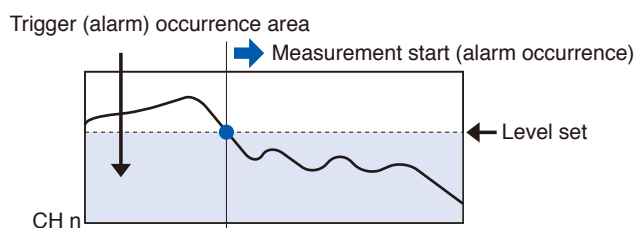

Win in: Condition where a trigger/alarm occurs when for any channel, the upper and lower limit value is set, and an input signal between those levels is input (when a signal is input).

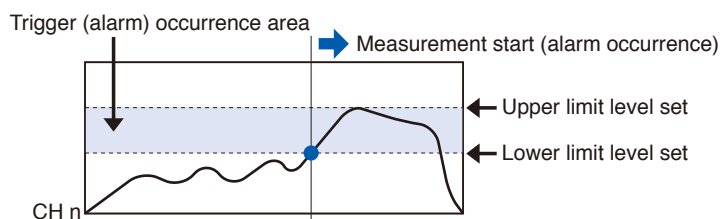

Win out: Condition where a trigger/alarm occurs when for any channel, the upper and lower limit value is set, and an output signal between those levels is output (when a signal is output)

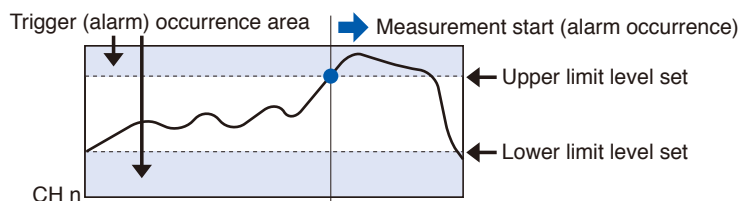

* These figures explain Trigger modes, but also work with alarm mode.

Detection of the trigger

To improve the detection rate of the trigger in the GL7000, the detection of the trigger is performed in the following interval, regardless of the sampling interval.

Therefore, when the sample interval is slower than the following detection interval of the trigger, or the measured signal is changed faster than the sample interval, the data at the trigger establishment may not be recorded, even if the trigger is successfully established.

<Trigger detecting interval>

- High-speed Voltage module (GL7-HSV) : 1 μ s
- Voltage module (GL7-V) : 1 ms
- Voltage/Temperature module (GL7-M) : Sampling interval is 10 ms or less (10 ms).
Sampling interval is 20 ms to 2 s (sampling interval).
Sampling interval is 5 s or more (5 s).
- Logic/Pulse module (GL7-L/P) : 1 s when Logic is used.
100 μ s when Pulse is used.
- High Voltage module (GL7-HV) : 1 μ s

(12)-4 Level/Upper limit value/Lower limit value

Set the trigger comparison level.

If the mode is "High" or "Low", it's set to a 1 field comparison level. If the mode is "Win in" or "Win out", its set to a 2 field comparison level.

Hysteresis

A hysteresis is set up in the trigger levels in order to prevent false positives due to noise. The hysteresis is as shown on the chart below.

Therefore, even for level sets, errors as shown in the chart below may occur.

<Ex.>

Combination : Edge OR

Mode : High

Level : 0.5 V

● When the hysteresis is not provided

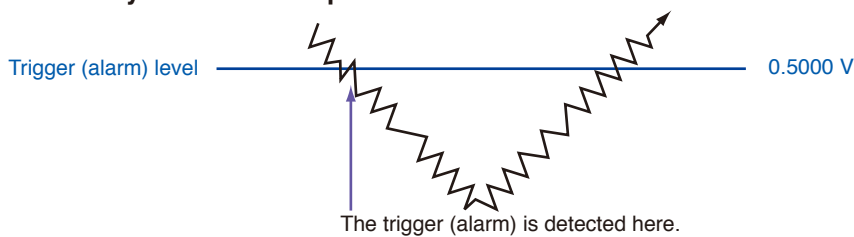

* If the hysteresis is not provided, the rising may be detected even when the rising has been set.

● When the hysteresis is provided (GL7000)

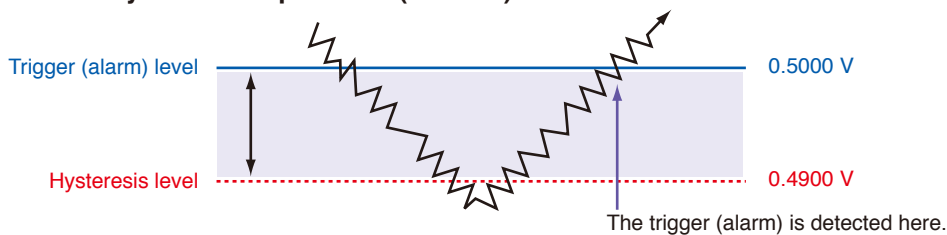

* For Rising mode, when the signal level drops below the hysteresis level at a time, and then becomes greater than or equal to trigger (alarm) level, the trigger (alarm) is detected.

Hysteresis level

Each Hysteresis level is as shown below.

● <Mode: Rising>

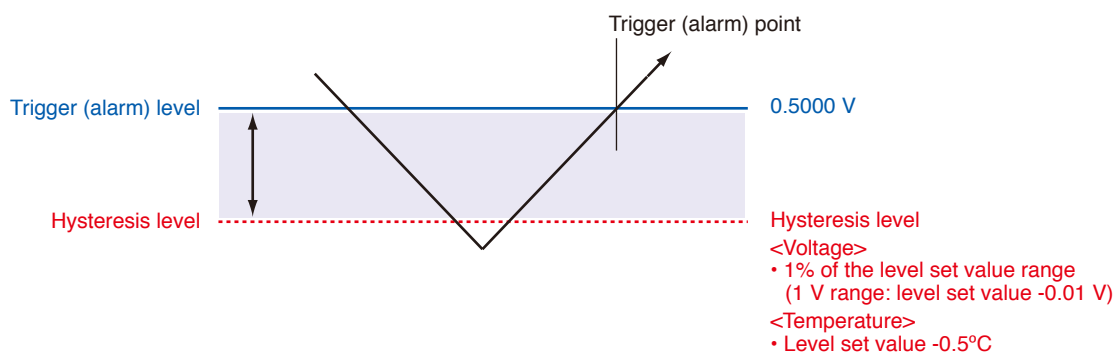

CHECKPOINT

- The upper limit values within the mode range and the lower limit values out of the mode range are hysteresis level as well.
- An error of the trigger (alarm) level is the same as the voltage accuracy and temperature accuracy.
- When the detected alarm drops below the hysteresis level, it is cleared. (When the alarm is retained).
- For Pulse mode, the Hysteresis level is not provided.

● <Mode: Low>

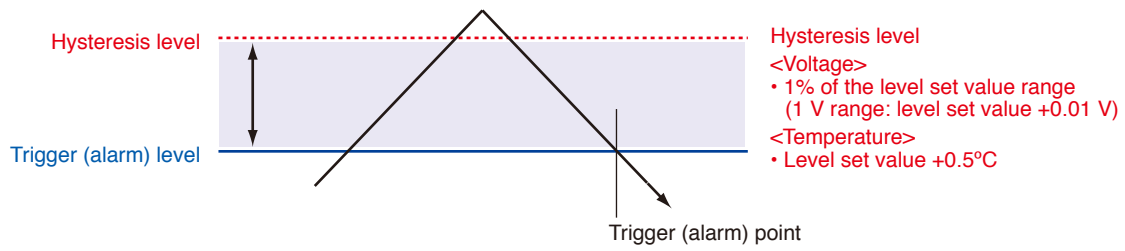

CHECKPOINT 

- The upper limit values within the mode range and the lower limit values out of the mode range are hysteresis level as well.
 - An error of the trigger (alarm) level is the same as the voltage accuracy and temperature accuracy.
 - When the detected alarm drops below the hysteresis level, it is cleared. (When the alarm is retained).
 - For Pulse mode, the Hysteresis level is not provided.
-

(13) Alarm level settings

("Home" → "Each Amplifier Module" → "Alarm level settings")

Set alarm occurrence conditions, output destination etc. If the conditions set here are satisfied, an alarm is output from the Alarm Module terminal (specifies the output destination number for each CH).

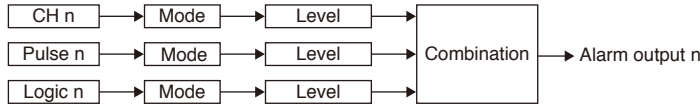

- Pulse and Logic changes per module.
- Combination settings for each module may be set to only one type. All modules are set to the same settings. When the settings are changed, all modules are set to the same content.
- Specifies alarm output for each CH, Pulse and Logic. If the combined settings of the alarm output are established, the alarm is outputted.

<Ex.> If the output destination is set to 1 for CH1 and CH2, and 2 for CH3 and CH4, and Level OR for combination, when the conditions for either CH1 or CH2 are satisfied, alarm output 1 occurs, and when the conditions for either CH3 or CH4 are satisfied, alarm output 2 occurs.

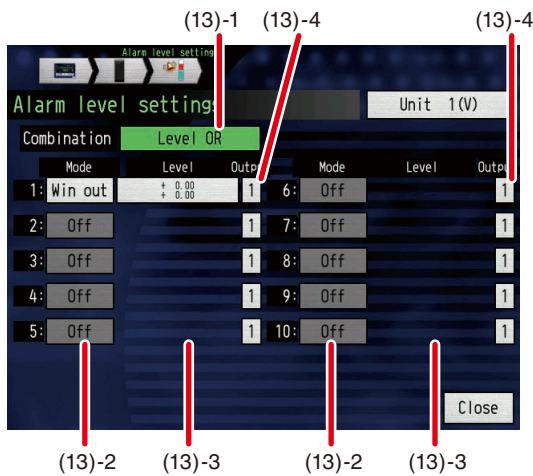

Item select		Examples of item	
(13)-1	Combination	Level OR, Level AND, Edge OR, Edge AND	
(13)-2	Mode	Off, H, L, Win in, Win out	
(13)-3	H	Level	Numerical entry
	L	Win in	Upper level/ Upper limit value Numerical entry
	Win out	Lower level	Numerical entry
(13)-4	Output	1 to 10 (Numerical entry)	

(13)-1 Combination

Set combinations of alarm conditions for each channel.

Item select	Description
Level OR	If at least 1 of the set alarm conditions is satisfied, the alarm of specified number is output. Each condition becomes a level action.
Level AND	If all of the set alarm conditions are satisfied, the alarm of specified number is output. Each condition becomes a level action.
Edge OR	If at least 1 of the set alarm conditions is satisfied, the alarm of specified number is output. Each condition becomes an edge action.
Edge AND	If all of the set alarm conditions are satisfied, the alarm of specified number is output. Each condition becomes an edge action.

CHECKPOINT

- The level action/edge action is same as the trigger level. For details, see "Level action and edge action" on page 3-106.
- When the combination of the alarms is set to "Edge OR" or "Edge AND", the alarms are retained regardless of this setting.
- When the alarms are not retained, set the combination of the alarms to "Level OR" or "Level AND".

(13)-2 Mode

Determine the alarm mode for each channel. For details, refer to "(12)-3 Mode" on page 3-130.

(13)-3 Level/Upper limit value/Lower limit value

Set the levels that determine the alarm.

If the mode is "High" or "Low", it is set to a 1 place comparison level. If the mode is "Win in" or "Win out", it is set to a 2 place comparison level.

For details, refer to "(12)-4 Level/Upper limit value/Lower limit value" on page 3-131.

(13)-4 Output

Specify the output destination when an alarm occurs. If multiple CH are set to the same number, it's determined according to preset combinations.

<Ex.>: If the CH1 and CH2 of the amplifier are both set to the number 1 terminal, and the combination is level AND, if an alarm is established on both CH1 and CH2, output will occur on the number 1 alarm output terminal.

(14) Waveform setting (Simple Waveform Setting)

("Home" → "Waveform settings")

Carries out settings related to waveform and digital display.



Item select		Examples of item	
(14)-1	Span/Position /Trace	↑ Up	▷ Execute
		↓ Down	▷ Execute
		↕ Expand	▷ Execute
		✳ Reduce	▷ Execute
		Trace	▷ Execute
(14)-2	Zone setting	1-zone, 2-zone, 5-zone, 10-zone	
(14)-3	Time/Div	1/2/5/10/20/50/100/200/500us/DIV, 1/2/5/10/20/50/100/200/500ms/DIV, 1/2/5/10/20/30sec/DIV, 1/2/5/10/20/30min/DIV, 1/2/5/10/12/24hour/DIV	

(14)-1 Span/Position/Trace

Turns the waveform display On/Off and lets users change settings related to vertical display.

Touching the button for Span/Position/Trace will display the Waveform screen below. You can change the settings while viewing the waveform.

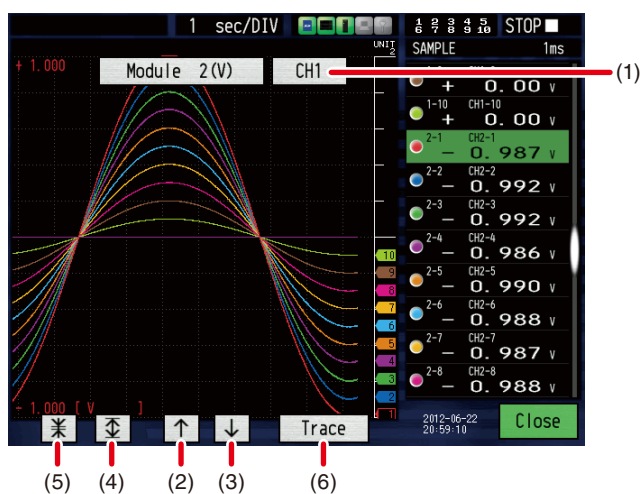

Item select	Description
(1) Channel Selection	Selects the channel for the waveform processing.
(2) ↑ Up	Moves the waveform up.
(3) ↓ Down	Moves the waveform down.
(4) ⇕ Expand	Expand the waveform.
(5) ⇐ Reduce	Reduce the waveform.
(6) Trace	Changes the waveform display to On/Off.

(14)-2 Zone setting

Set the zone for waveform display.

CHECKPOINT

If a zone is set, the channel displayed in each zone is fixed and can not be changed.

(14)-3 Time/DIV

Set the timescale on the horizontal axis of the waveform display.

CHECKPOINT

When displaying the waveform during free running or during recording, it's displayed from 100ms/DIV. During data replay it's displayed from recorded sampling rate/DIV.

(15) Display settings

Set display related settings.

("Home" → "Display settings")

<Y-T display settings>



<Y-T (fullscreen) display settings>



<Logger display settings>

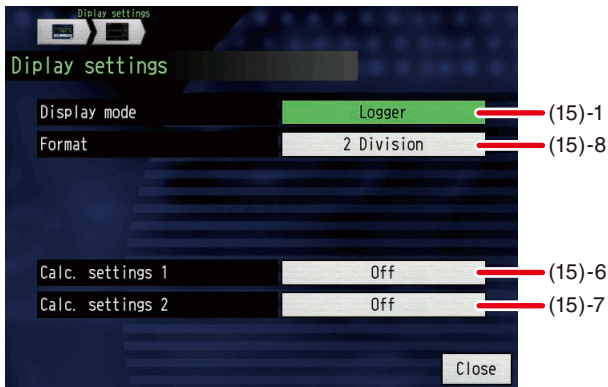

<XY display settings>

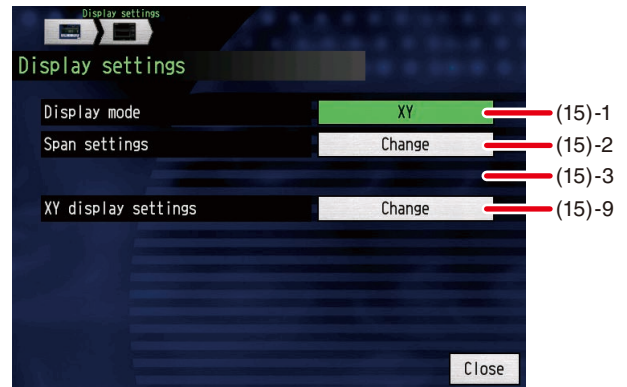

<FFT display settings>

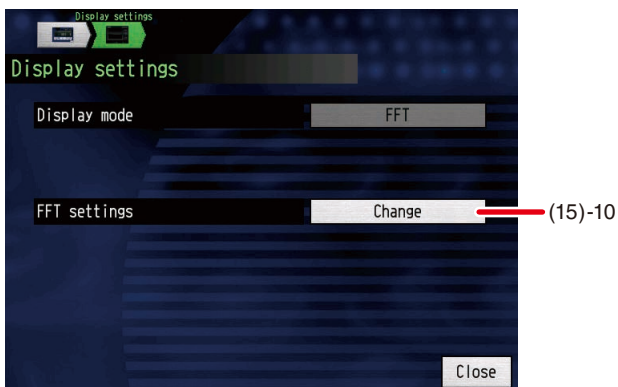

Item select		Examples of item	
(15)-1	Display mode	Y-T, Y-T (Fullscreen), Logger, XY, FFT	
(15)-2	Span settings	Upper	Numerical entry
		Lower	Numerical entry
(15)-3	Pulse span settings	Upper	Numerical entry
		Lower	Numerical entry
(15)-4	Zone setting	1 zone, 2 zone, 5 zone, 10 zone	
(15)-5	Trace settings	▷ Execute	
(15)-6	Calc. settings 1	Off, Average, Max, Min, Peak	
(15)-7	Calc. settings 2	Off, Average, Max, Min, Peak	
(15)-8	Format	2-Division, 4-Division, 10-Division, Statistics	

Item select			Examples of item		
(15)-9	XY display settings	Trace	Execute		
		X-Axis	CH1 to CH112		
		Y-Axis	CH1 to CH112		
		Color	Red, Green, Blue (RGB) Each color 0 to 31		
(15)-10	FFTdisplay settings	Frequency	0.08, 0.2, 0.4, 0.8, 1.6, 2, 3.2, 4, 8, 20, 40, 80, 200, 400, 800 Hz, 2, 4, 8, 20, 40, 80, 200, 400 kHz		
		Number of analysis points	500, 1000, 2000, 4000, 10000		
		Time window	Rectangular, Hanning, Hamming, Blackman, Flattop, Exponential		
		Average mode	Off, Summation, Exponential, Peak hold		
		Average count	Automatic		
			Optional	Enter the number. (Lower limit value: 2, Upper limit value: 9999)	
		Display settings	Display format	1-divided, 2-divided, Nyquist	
			Grid	Off, On	
			Zone	Zone1, Zone2 (Displayed with the settings of Zone1 and Zone2)	
			Function	Y-T, Linear, Power, PSD, Cross, TRF, Coherence, COP	
			X Axis	Linear, Log	
			X Axis function	Frequency, Cycle	
			Y Axis	Linear, Log, Phase	
			Y Axis auto scale	Off, On	
			Trace		Settings of 1 to 4 types
				Trace	Off, On
		CH A		Selection of the calculation channel	
		CH B		Selection of the calculation channel	
		Waveform color		Selection of the combination of Red, Green and Blue	
		Calculation settings	Zone	Zone1, Zone2 (Displayed with the settings of Zone1 and Zone2)	
			CH	Settings of 1 to 4 types	
			Calculation	CH A Calculation	None, Differential, D-Differential, Integral, D-Integral
				CH B Calculation	None, Differential, D-Differential, Integral, D-Integral
RMS	Off, On				
Smoothing	Off (The setting range of the smoothing varies depending on the analysis frequency.)				

(15)-1 Display mode

Changes the display mode.

<Y-T display>

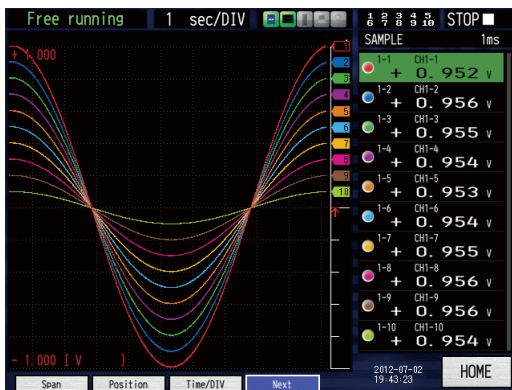

<Y-T (fullscreen) display>

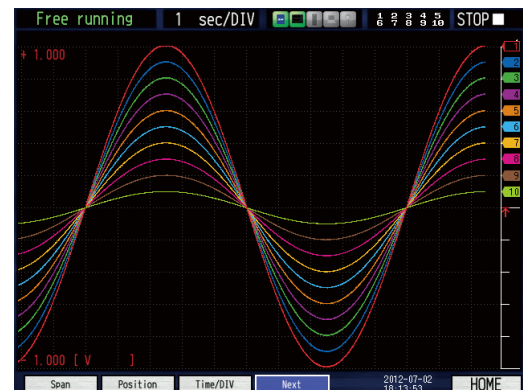

<Logger display>



<X-Y display>



<FFT Display>

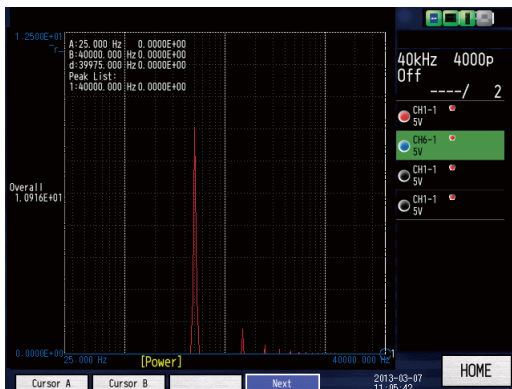

(15)-2 Span settings

Set the upper and lower limit values for the waveform display span.

CHECKPOINT

This setting is shared with the amplifier span setting.

(15)-3 Pulse span settings

This is available only when the pulse is set in the Logic/Pulse module.
Set the upper and lower limit value for the pulse waveform display span.

CHECKPOINT 

- This setting is displayed when a Logic/Pulse module is connected and a pulse is set.
- This setting is shared with the amplifier span setting.

(15)-4 Zone setting

Set the zone of waveform display.

CHECKPOINT 

If a zone is set, the channel displayed in each zone is fixed and can not be changed.

(15)-5 Trace settings

Change the display waveform to On/Off for each channel.

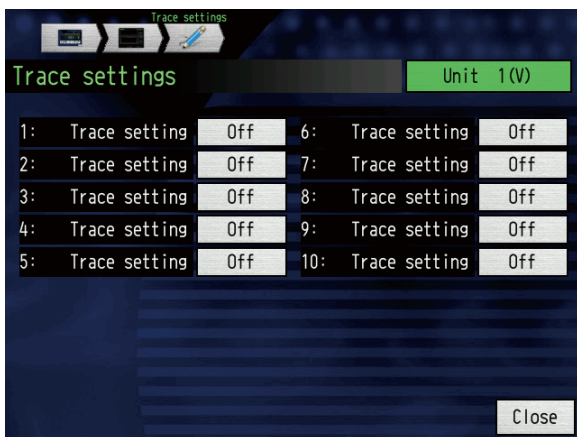
**CHECKPOINT** 

Trace settings do not affect recorded data.

(15)-6, 7 Calc. settings

2 statistics calculations can be executed on the GL7000.
Here the statistics calculation contents is set.

<Sample of the statistical calculation>

CH	VALUE	Max	Min
1-1	+ 0.00 V	+ 0.00	+ 0.00
1-2	+ 0.00 V	+ 0.00	+ 0.00
1-3	+ 0.00 V	+ 0.00	+ 0.00
1-4	+ 0.00 V	+ 0.00	+ 0.00
1-5	+ 0.00 V	+ 0.00	+ 0.00
1-6	+ 0.00 V	+ 0.00	+ 0.00
1-7	+ 0.00 V	+ 0.00	+ 0.00
1-8	+ 0.00 V	+ 0.00	+ 0.00
1-9	+ 0.00 V	+ 0.00	+ 0.00
1-10	+ 0.00 V	+ 0.00	+ 0.00

Item select	Description
Off	Calculation process was not carried out.
Average	During recording, the data simple addition average is displayed on the screen.
Max	During recording, the maximum value of the data is displayed on the screen.
Min	During recording, the minimum value the data is displayed on the screen.
Prak	During recording, the peak value of the data is displayed on the screen.

CHECKPOINT

- The result of the calculation is displayed on the Digital + Statistical Calculation screen in the logger display mode.
- Calculation is started from when the power is turned on, and is cleared by pressing the QUIT key or by pressing the Start key to start measurements.
- Realtime statistics calculation is usable when the sampling rate is slower than 100ms. When the sampling rate is faster than 100ms, use the statistics calculation of the cursor functions after replaying recorded data.

(15)-8 Format

If the display format is a logger, set the format of the logger display.

< 2-Division >

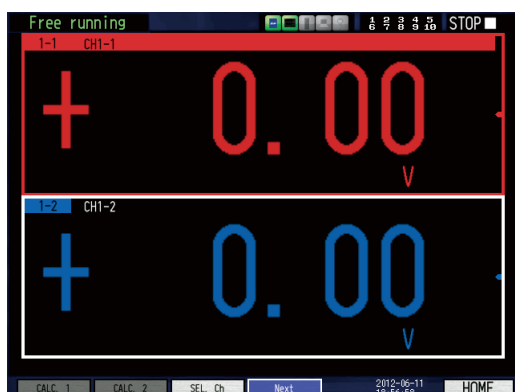

< 4-Division >



< 10-Division >



< Statistics >

CH	VALUE	Max	Min
2-1	- 0.732 V	+ 1.011	- 0.992
2-2	- 0.739 V	+ 1.005	- 0.998
2-3	- 0.739 V	+ 1.007	- 0.997
2-4	- 0.736 V	+ 1.012	- 0.993
2-5	- 0.736 V	+ 1.010	- 0.994
2-6	- 0.736 V	+ 1.010	- 0.995
2-7	- 0.734 V	+ 1.011	- 0.991
2-8	- 0.736 V	+ 1.009	- 0.993
2-9	- 0.738 V	+ 1.009	- 0.995
2-10	- 0.691 V	+ 1.011	- 0.993

How to set the channel to be displayed

This section explains how to set the channel to display in each zone.

- (1) By touching the direction keys or directly touching on the screen, select the zone to change the channel. In this case, you can change the Ch1-3.



(2) Touch "SEL CH" function button.

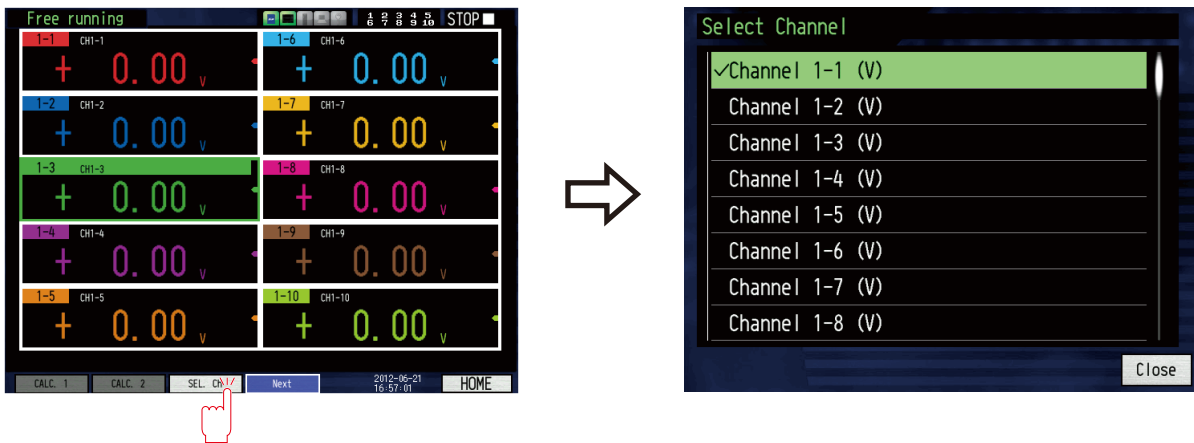

(3) Select the channel you want to view (touch twice).

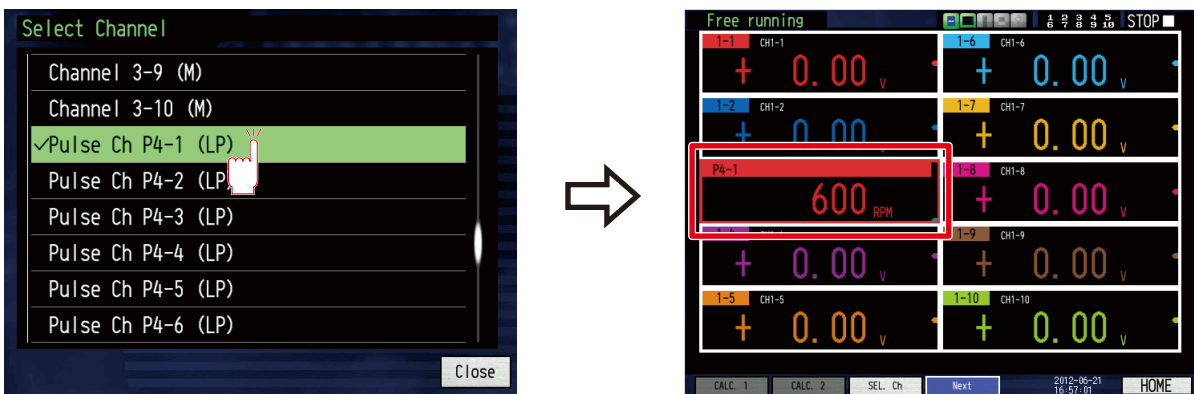

(15)-9 XY display settings

Perform XY display settings.



Item select		Description
(1)	Trace	Select whether to display the waveform or not.
(2)	X-Axis	Set the channel to assign to X-axis of each XY waveform.
(3)	Y-Axis	Set the channel to assign to Y-axis of each XY waveform.
(4)	Color	Set the waveform color.

How to operate the XY display

This section explains how to operate the XY display screen.

(1) Drawing waveform

When "Pen down" function key is touched, the drawing of the waveform XY is performed.

When "Pen up" function key is touched, the screen changes to the trajectory display without subsequent drawing.



(2) By touching "Clear", the drawing of the XY waveform is deleted.



(3) When the recording starts, waveform clear and pen down are started up automatically, and then the XY waveform is drawn.

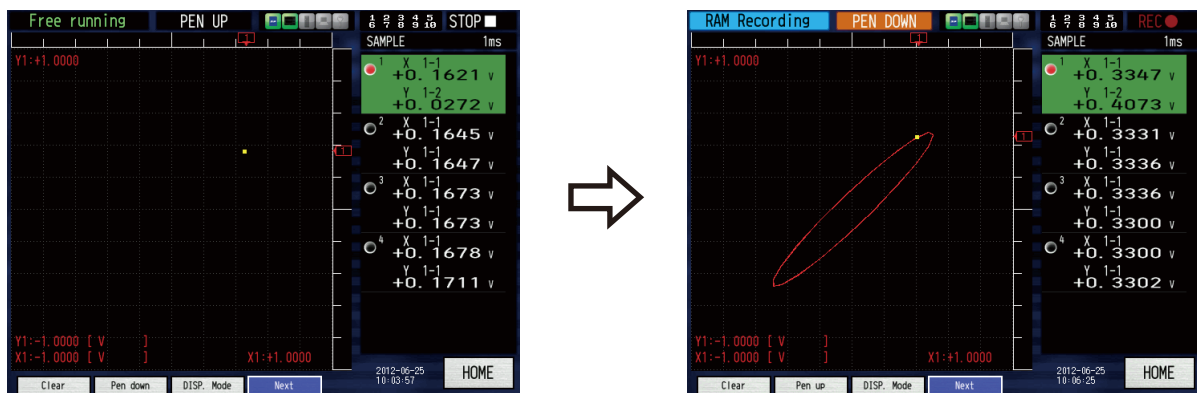

CHECKPOINT

- When the recording starts, pen down are started up automatically, after finishing the recording, moves to pen up state.
- Even if the XY waveform drawing is cleared during recording, the data is not affected during recording.
- When the Span Position Trace, etc. are changed during XY replaying, conduct a redraw.

(15)-10 FFT Display settings

This section provides the descriptions of the FFT display settings.

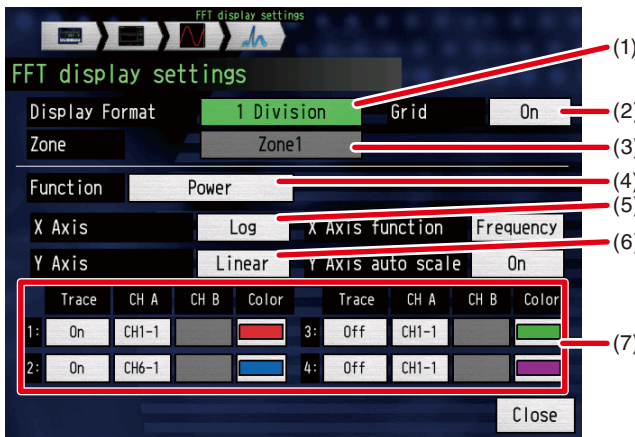

Item select	Description
(1) Display format	Select 1-divided, 2-divided, or Nyquist for FFT screen
(2) Grid	Switch the grid display to On or Off.
(3) Zone	Set the analysis method of the Zone1 or Zone2 when the 2-divided is selected in the Display format.
(4) Function	Select Y-T, Linear, Power, PSD, Cross, TRF, Coherence or COP for FFT analysis.
(5) X Axis	Select either Linear or Log for X Axis analysis display. Select either Frequency or Cycle for X Axis analysis function.
(6) Y Axis	Select either Linear or Log for Y Axis analysis display. Display the scale properly by switching Y Axis auto scale to On.
(7) Trace	Select the analysis channel. Select CH1 or CH2 for Cross, TRF, Coherence and COP in the Function settings.

1. Display format

- Up to 4 calculation settings can be set in both the 1-divided and 2-divided. FFT analysis of one channel data is displayed.
- The Nyquist allows you to confirm that the correct TRF has been obtained.

The FFT analysis is displayed in one figure by assigning the real part to the vertical axis and the imaginary part to the horizontal axis. Therefore, it is calculated as X Axis is disabled and Y Axis is Linear or Log.

* Nyquist display conditions are not available for Y-T and coherence funtions.

<1-divided>

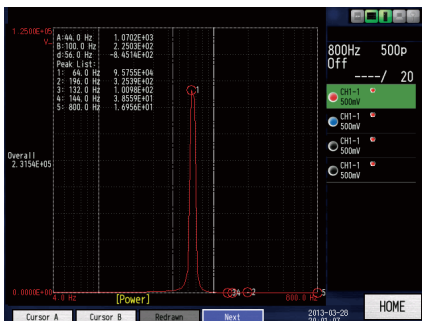

<2-divided>

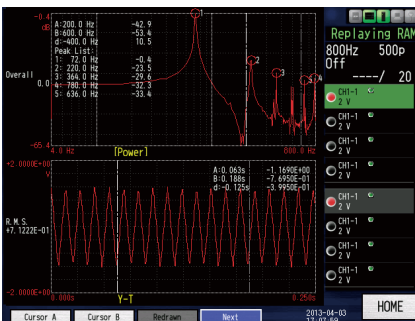

<Nyquist>

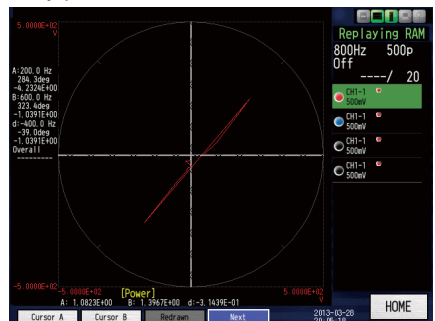

2. Function

Y-T : When X Axis is fixed to the Time, Y Axis is fixed to the Linear, the change of the input signal with respect to the time axis is displayed.

Linear (Linear Spectrum) : Based on the results of the time axis data processed with FFT calculation, the amplitude or phase of each frequency is displayed.

Power (Power Spectrum)

: Based on the results of the time axis data processed with FFT calculation, the power of each frequency component is displayed.

PSD (Power Spectrum Density)

: The power spectrum per unit interval of frequency is known as PSD. Since the results of the FFT analysis is the value of integral for the spectrum distributed on the bandwidth (Range of the frequency resolution) determined from the analysis frequency and number of analysis points, the power spectrum of the signal such as a continuous spectrum is a value that varies depending on the settings of the analysis frequency range and the number of analysis points. When there is the signal that the spectrum is distributed in such a broad band and the signal is measured with the power spectral density, the cross spectrum measured regardless of the analysis frequency range and the number of analysis points is multiplied by the spectrum of two signals for each frequency component, and the magnitude of the power and the correlation of two signals are displayed.

Cross (Cross Spectrum)

: The cross spectrum measured is multiplied by the spectrum of two signals for each frequency component, and the magnitude of the power and the correlation of two signals are displayed.

The cross spectrum allows you to reduce greatly the effects of noise, as compared with the case where only the power spectrum of the output signal is measured, by averaging the measured cross spectrum of the input and output signals even if there are a system that the noise is mixed in the input signal.

TRF (Transfer function)

: The TRF showing the relationship between the input and output signals can be determined by calculating the ratio of the cross spectrum of the input and output signals and the power spectrum of the input signal.

Similar to the cross spectrum, the averaging process allows you to reduce the effects of noise mixed in the system. However, the input signal contains frequency component across the analysis frequency is required to measure the TRF across the analysis frequency.

Coherence (Coherence Function)

: The coherence is determined by calculating the ratio of the squared amplitude of the cross spectrum of the input and output signal and the product of the power spectrum of the input and output signals, and then the causal relationship between the input and output signals are displayed. The value of the coherence function is between 0 and 1. When the coherence function is 1, all the output signal is caused by the input signal, and when it is 0, the output signal is independent of the input signal at all. The measurement of the coherence function allows you to confirm the reliability of the measurement, such as the TRF. Note that, when the averaging process is not performed, all the value of the coherence function is 1. When using the coherence function, make sure to perform the averaging process.

COP (Coherent Output Power)

: The product of the coherence function and the power spectrum of the output side is displayed.

This is the contents of the FFT Calculation settings screen.

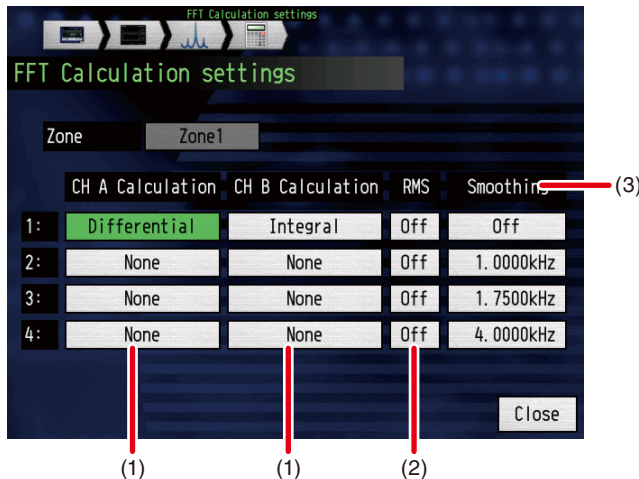

Item select	Description
(1) CH A Calculation CH B Calculation	Set this setting for only the channel you have set the Linear, Power, PSD, Cross, TRF, and Coherence. None, Differential, D-Differential, Integral, or D-Integral can be set as the possible calculation.
(2) RMS	Set this setting only when Linear, Power, PSD, or Cross is set. When this setting is On, Y Axis is displayed with RMS scale.
(3) Smoothing	When the moving average is performed with any frequency width with respect to the results of FFT calculation, the waveform is smoothed. You can select from the items that are calculated from the analysis frequency and the number of analysis points.

* Zone is enabled when the Display format is set to the 2-divided in FFT display settings.

* It is possible to set to 1 to 4 for the calculation.

This is the contents of the FFT Calculation Result Display screen.

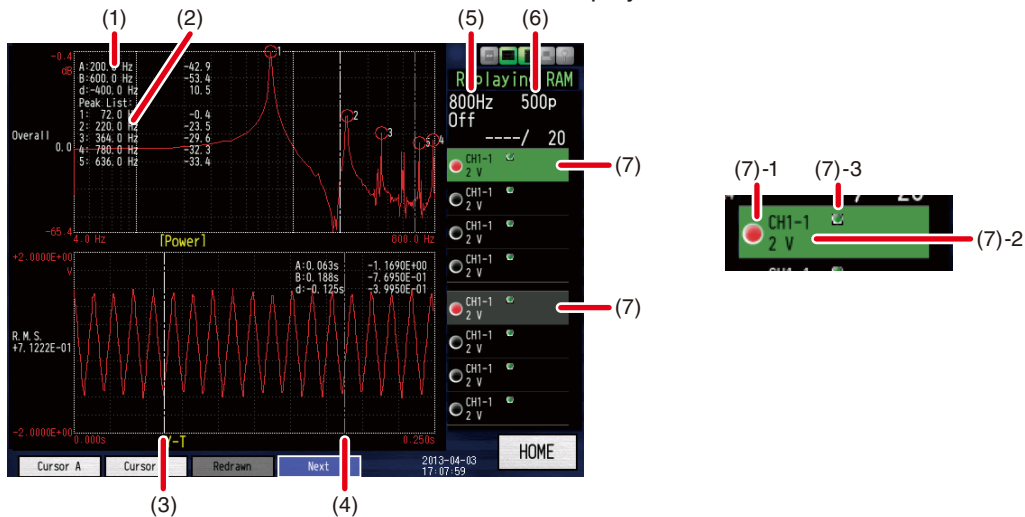

- (1) Cursor resulting data display: The data of A and B cursors, and difference data between A and B are displayed.
- (2) Peak List: The top five of the peak waveforms in the analysis results are displayed.
- (3) A cursor display
- (4) B cursor display
- (5) Analysis frequency display
- (6) Number of analysis points display
- (7) Green frame is the active zone. To activate the gray frame, touch the gray frame to switch to green.
 - (7)-1 When the trace starts, the red lamp for each CH is lit.
 - (7)-2 The set CH and range are displayed.
 - (7)-3 When the set range is other than Off, the green lamp is lit. When the value is scaled over, the red lamp is lit.

(15)-11 How to operate the FFT display

This section explains how to operate the FFT display screen.

FFT analysis is performed with the recorded data or the internal RAM operation.

For how to save the analysis result data, refer to "(17) Saving Data".

1. Analysis of recorded data

FFT analysis can be performed by reading the data recorded in Y-T mode, etc. in FFT display mode.

In the analysis, select the waveform to be analyzed with the cursor after Y-T replaying, and FFT calculation is performed for the data within the region.

For reading the data, refer to "(16) Replay setting screen (Data Replay screen)".

2. Direct FFT

When the analysis frequency is less than 400 Hz or the trigger is On (enabled) in the FFT Display Mode, the internal RAM is fixed, and when it is 400 Hz or more, the FFT analysis is displayed with the buffer memory function.

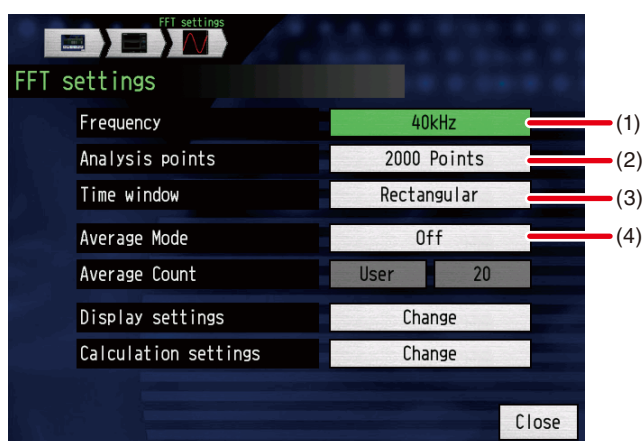

Item select	Description
(1) Frequency	The analysis frequency on X Axis can be set by selecting 0.08Hz to 400kHz analysis frequency.
(2) Analysis points	The number of recorded data in a single measurement can be determined by selecting the analysis points (500, 1000, 2000, 4000, 10000).
(3) Time window	The waveform is analyzed by selecting Rectangular, Hanning, Hamming, Blackman, Flattop or Exponential.
(4) Average mode	When Average mode is set to Summation, Exponential or Peak hold, the results processed with the average count are displayed. The resulting data is displayed superimposed in white.

2-1. This section provides the descriptions of FFT setting.

<Setting procedure>

- (1) Set the Frequency range for analysis. The Range indicates the value of the maximum frequency. The frequency depends on the measuring module.

Module name	Model	Frequency
Voltage module	GL7-V	400Hz
Voltage/Temperature module	GL7-M	40Hz
High speed voltage module	GL7-HSV	400kHz
High-voltage module	GL7-HV	400kHz
DC strain module	GL7-DCB	40kHz
Charge module	GL7-CHA	40kHz

- (2) The number of analysis points indicates the number of data to be measured. When the number of analysis points increases, the time of a single analysis is longer.
- (3) Determine how to analyze after setting the time window.
For more information on the main time window, refer to "2-2 Time window on page 3-149.

- (4) Set the number of measurement data processing.
 When the averaging is off, the results of a single measurement is displayed.
 When the averaging and the number of times are selected, the results are displayed superimposed according to the average processing times.
- (5) Set Display format, Function, X Axis, and Y Axis in FFT Display Setting screen.
- (6) When the above settings are completed, press the START key on this module. The results of FFT analysis are displayed.
 The data is automatically recorded and analyze with the internal RAM.
- (7) Pressing the STOP key displays the last analysis results. You can confirm the detailed information using the cursor.

2-2. This section provides the descriptions of the Time window.

The input signal to be FFT analyzed is an infinite continuous signal, however only the signal within the finite time called Time window in infinitely continuous signal is subject to analysis. In FFT mode of the module, there is the following relationship to the time window length and analysis frequency.

$$\text{Time window length} = \frac{0.4}{\text{Frequency [Hz]}} \times \text{Number of analysis points [sec.]}$$

(The number of analysis points in FFT mode is 500, 1000, 2000, 4000, or 10000 points.)

<Rectangular>

No action is taken for the signal that is cut away with the time window. When the time window is used to cut the normal continuous waveform, the signal is affected by cutting with the Time window. However, when using the signal such that the length of waveform and time window match to an integer multiple of the period by attenuating within the time window, the result not affected by the time window can be obtained.

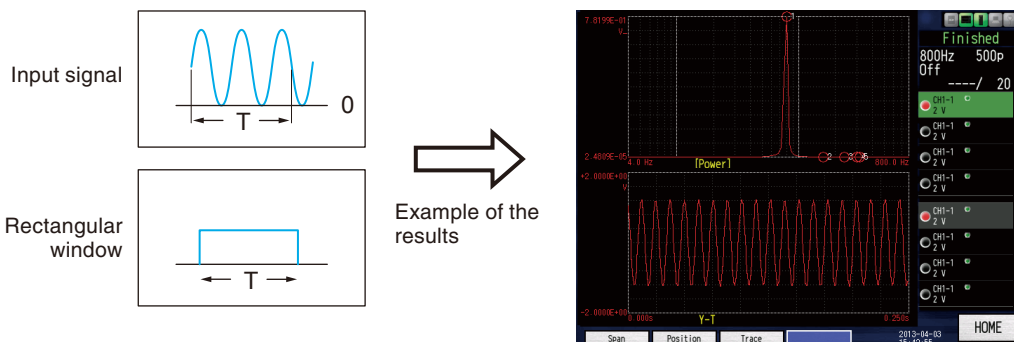

<Hanning>

The time window displays so that the input signal is zero smoothly at start and end points in consecutive. Since the input is zero at both ends of the time window, even if the continuous waveform is cut, the effects of the cut can be minimized.

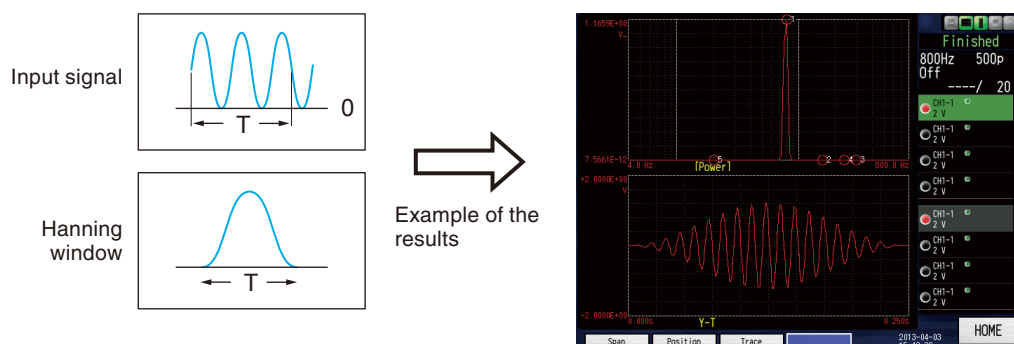

<Hamming>

The hamming window is suitable to separate the signals in close proximity in comparison to the hanning window.

Make an attempt to use the Hamming If you can not improve sufficiently the frequency resolution.

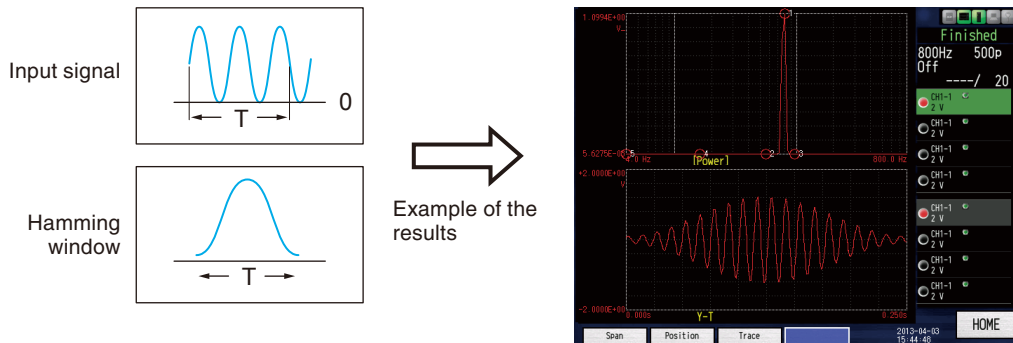

<Blackman>

The frequency resolution is lower than Hanning and Hamming, however even the smaller signal can be analyze because of a wider dynamic range.

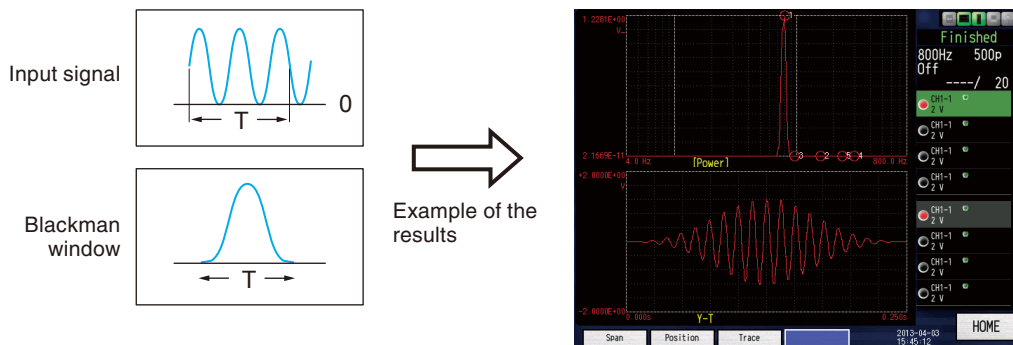

<Flattop>

The amplitude can be accurately measured by flattop the peaks with the low ripple time window function.

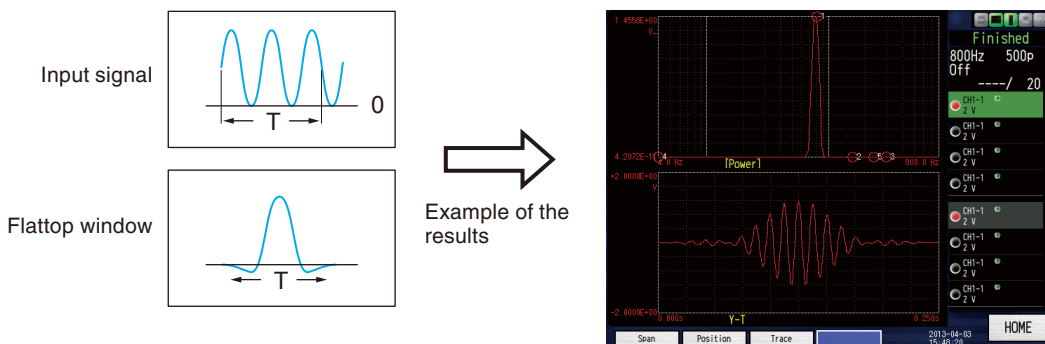

<Exponential>

Since this exponential is asymmetrical, it is used to perform the time asymmetric waveform analysis such as echo detection.

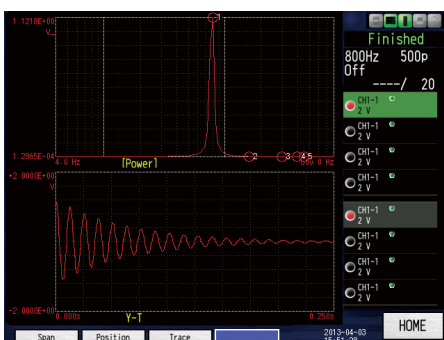

2-3. Averaging process

The noise component contained in the signal is removed by performing the averaging process.

Summation : The averaging process is performed depending on the number of measurements.

Exponential : With the progress of the Average count, the weight to be added is reduced.

Peak hold : The peak for each frequency is hold-processed in the specified number of times.

(16) Replay setting screen (Data relaying screen)

Select the data for replay display.

("Home" → "Replay")

<In case of built-in RAM>

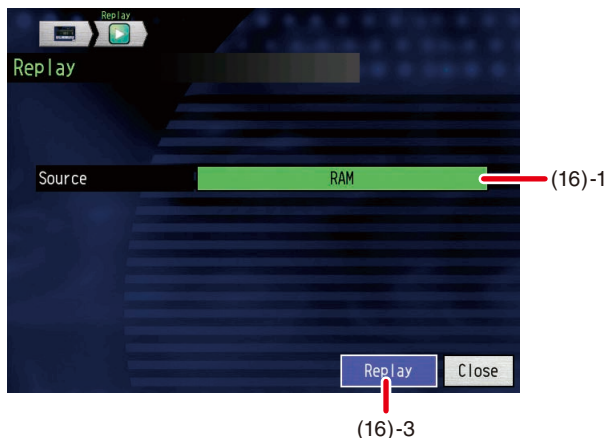

<In case of something other than built-in RAM>

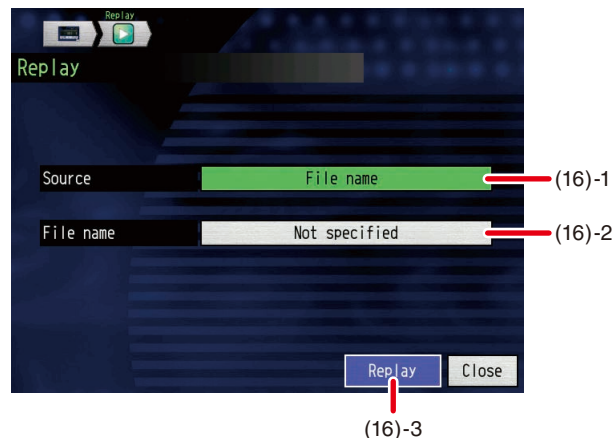

Item select		Description
(16)-1	Source	Built-in RAM, File
(16)-2	File name	File selection * The data recorded with CSV format cannot be replayed on the GL7000. * When dual sampling file (*.DSA) is selected, it is replayed with dual sampling.
(16)-3	Replay	▷ Execute

(16)-1 Source

Set the replay source.

Set from files in the built-in RAM.

(16)-2 File name

Set the file name to replay.

If the replay source is a file, select the file for replaying.

(16)-3 Replay

By pressing this button, the specified file is replayed and displayed on the screen.

(17) File operations

Contains operations such as file copy and folder creation. For operation methods related to file relations, refer to "(3) File operations" on page 3-32.

("Home" → "File operation").

(18) Data Save

Save the playback display data.

("Home" → "File" → "Data save")



Item select		Description
(18)-1	File name	Select or enter the file name.
(18)-2	Name type	Auto, User, Serial number
(18)-3	File type	GBD, CSV *FFT analysis results is created with CSV format only.
(18)-4	Save Range	All data, Data between cursors
(18)-5	Save	▷ Execute

(18)-1 File name

Specifies the file name of the recording destination (or save destination). For details, refer to "(3) File operations" on page 3-32.

(18)-2 Name type

Set how the data file is named.

Auto : The file is automatically named.
 <Ex.> 20120101-123456.GBD
 The numeric part... The day the file was created
 * E.g. 2012-01-01, 12:34:56
 GBD..... Data format
 GBD (Binary data)
 CSV (Text format)

User : Data is saved to a user-input file name.

Serial number : consecutive number is attached to the user-input file name to create the file name.

<Ex.> When the file name is "TEST"
 First : TEST_SER1.GBD
 Second: TEST_SER2.GBD
 Third : TEST_SER3.GBD

⚠ CAUTION

If the same file name already exists, it will be overwritten.

(18)-3 File type

Set the data file format.

GBD : Data file created using our company's original binary format.

CSV : Data file created with the text format.

The FFT display data is saved in the file in CSV format only (not be selected) from the FFT result.

* It cannot be replayed on the GL7000.

(18)-4 Save Range

Set the range of data to be saved.

All data: Regardless of the cursor location, saves all data.

Data between the cursors

: Cuts and saves only the area between both the A and B cursors.

* The measurement points data and results of the function operation and overall peak list are saved as the FFT data, regardless of the cursor operation.

(18)-5 Save

By pressing this button, data is saved according to the specifications.

(19) Save/Load current settings

Saves or loads and reflects the conditional settings of the GL7000.

("Home" → "File operation" → "Save/Load current settings")

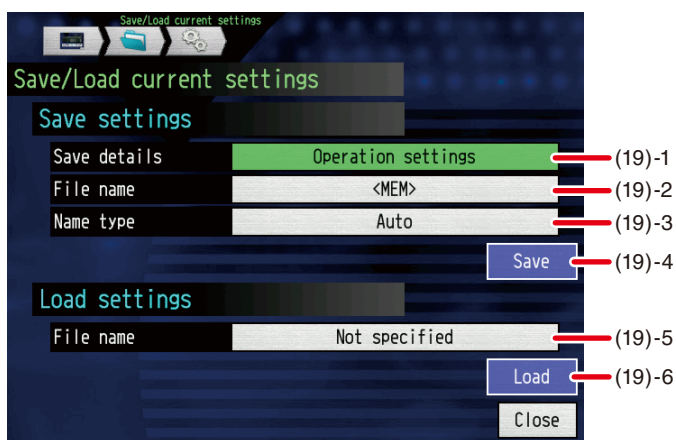

Item select		Examples of ite	
(19)-1	Save settings	Save description	Operation setting(*.CND) / Communication setting(*.NCD)
(19)-2		File name	Text entry
(19)-3		Name type	Auto, User, Serial number
(19)-4		Save	▷ Execute
(19)-5	Load settings	File name	Text entry
(19)-6		Load	▷ Execute

CHECKPOINT

The following settings can not be saved.

- Display mode, Y-T trace setting, and Display format of the logger.
- Recording destination, recording file name, auto save destination,
- AC line frequency, password for key-lock, and new-line character.
- TEDS information (Please save when setting the strain or charge module)

(19)-1 Saving contents

Set saving contents of setting data.

Operation setting: Save settings related to the operation of the GL7000.

Communication setting: Save settings related to communication settings.

(19)-2 File name

Specify the file name in the settings save destination.

For details, refer to "(3) File operations" on page 3-28.

(19)-3 Name type

Set how the data file name is attached.

Auto : The file is automatically named.

<Ex.> 20120101-123456.CND

The numeric par.... The day the file was created

* E.g. 2012-01-01, 12:34:56

CND Data format (The file format set on the machine)

User : Creates a setting file with the user-input file name.

Serial number : Data is recorded to a file name from the input name.

 CAUTION

If the same file name already exists, it will be overwritten.

(19)-4 Save

By pressing this button, settings are saved according to the specifications.

(19)-5 File name

Set the file name of the set load source. For details, refer to "(3) File operations" on page 3-32.

(19)-6 Load

By pressing this button, data is, according to specifications, loaded reflecting settings.

 CHECKPOINT

GL7000 can not read the setting file that the module configuration is different.

(20) Swapping out the SD card

When the GL7000 is recording data to the SD card, the SD card can be swapped. Follow the operations below to implement the swap.

CHECKPOINT

This function can be used even if sampling rate is slower than 100 ms.

- (1) When data is being recorded, press the "HOME" key or "Home" displayed on the screen to open the home menu.



- (2) Press "Change SD card".



- (3) As the message appears, remove the SD card.

SD card can be removed/exchanged.

During measurement, make sure that the replacement needs to be completed within 10 min.

Press [Yes] after removal/exchange.

Yes

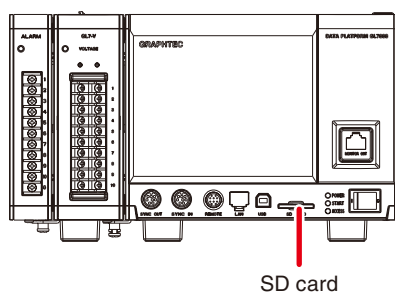

CAUTION

Please do not remove the SD card until this message appears. This can lead to data being damaged and/or becoming inaccessible.

- (4) Insert the new SD card.

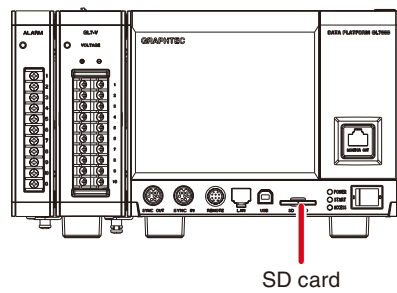
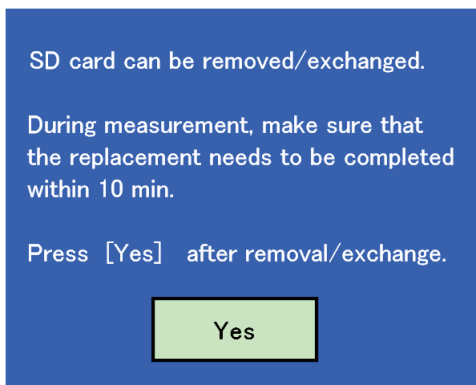

- (5) Press "Yes" displayed in the message or the "ENTER" key.

CHECKPOINT

- When swapping SD cards, _CHG[number] is added to the file name.
<Ex.> When recorded with the file name "TEST.GBD"
First SD card: TEST.GBD
Second SD card: TEST_CHG1.GBD
Third SD card: TEST_CHG2.GBD
- If ring capture is On, the SD card cannot be replaced.
- The GL7000 is compatible with SD and SDHC. (It is not compatible with SDXC.)

CAUTION

- Please implement the swap within 10 minutes. If it exceeds 10 minutes, data loss may occur.
- When relay capturing is set to On, SD card cannot be swapped.
- When dual sampling capturing is set to On, SD card cannot be swapped.
- When the backup is performing for the CSV Format, the SD-Memory Card exchange and the relay recording are not able to perform.

(21) Screenshot

Save the replayed data as an image file.

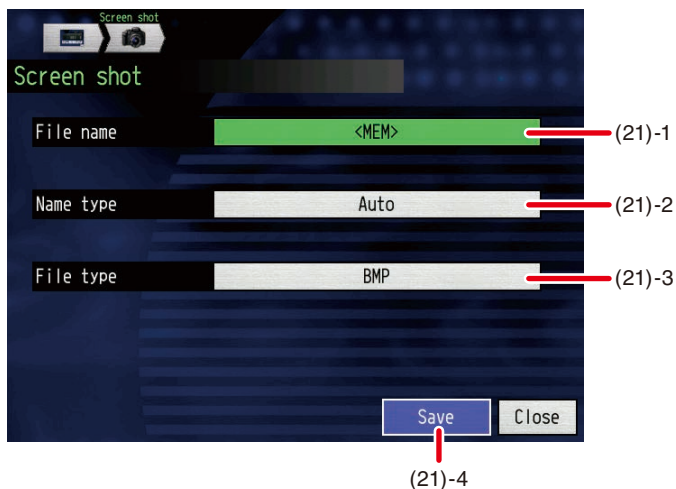

Item select		Description
(21)-1	File name	Text entry
(21)-2	Name type	Auto, User, Serial number
(21)-3	File type	BMP, PNG
(21)-4	Save	▷ Execute

(21)-1 File name

Set the image file name to be saved. For details, refer to "(3) File operations" on page 3-32.

(21)-2 Name type

Set how the image file name is attached.

Auto : The file is automatically named
 <Ex.> 20120101-123456.BMP
 The numeric part... The day the file was created
 * E.g. 2012-01-01, 12:34:56
 BMP Data format
 BMP (Bitmap format)
 PNG (Portable Network Graphics format)

User : The image is saved to a user-input file name.

Serial number : A consecutive number is attached to the user-input file name to create the file name.

⚠ CAUTION

If the same file name already exists, it will be overwritten.

(21)-3 File type

Set the data file format.

Set from BMP, PNG.

(21)-4 Save

By pressing this button, the image file is saved according to specifications.

(22) Cursor position

Move the cursor to a specified location.

<If cursor movement is positional>

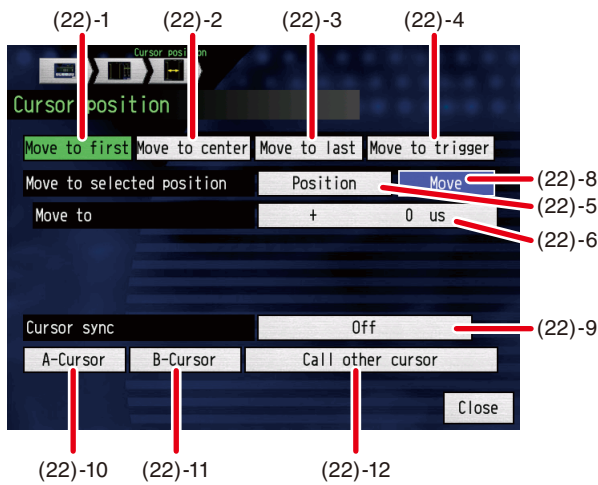

<If cursor movement is time based>

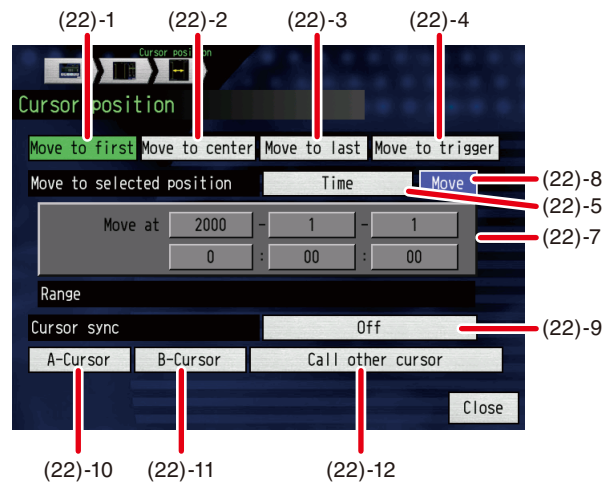

Item select		Examples of item	
(22)-1	Move to first	▷	Execute
(22)-2	Move to center	▷	Execute
(22)-3	Move to last	▷	Execute
(22)-4	Move to trigger	▷	Execute
(22)-5	Move to selected position		Position, Time
(22)-6		[Position]	Move to
(22)-7		[Time]	Move at
(22)-8	Move	▷	Execute
(22)-9	Cursor sync		Off, On
(22)-10	A-Cursor	▷	Execute
(22)-11	B-Cursor	▷	Execute
(22)-12	Call other cursor	▷	Execute

(22)-1 Move to first

Upon execution, the currently selected cursor (A or B) moves to the top data.

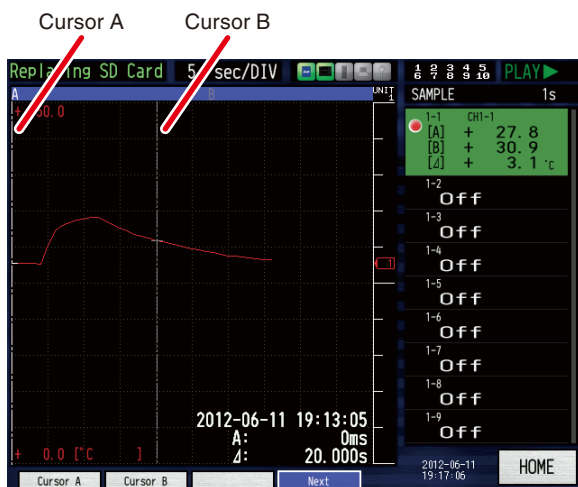

(22)-2 Move to center

Upon execution, the currently selected cursor (A or B) moves to the center data.

(22)-3 Move to last

Upon execution, the currently selected cursor (A or B) moves to the bottom data.

(22)-4 Move to trigger

Upon execution, the currently selected cursor (A or B) moves to the trigger point.

(22)-5 Move to selected position

Set the movement destination selection method. Position and/or time can be set.

(22)-6 Move position

Set the position of the movement destination. If the recording start is 0, it sets how much how much further the position should move. Can only be set at the final data point.

(22)-7 Move date/time

Set the movement destination by date and time. Can only be set at the final data point.

(22)-8 Move

When executing, the currently selected cursor (A or B), moves to the desired position or desired date/time.

(22)-9 Cursor sync

When moving the cursor, set the function for moving 2 at the same time.

Item select	Description
Off	Only one specific cursor will move.
On	Moving 2 cursors synchronously. The fulcrum is already A.

* Cursor synchronization functions are turned off when carrying out cursor movements such as movement to a selected position or data retrieval.

(22)-10 A-Cursor

Upon execution, A-Cursor is selected.

(22)-11 B-Cursor

Upon execution, B-Cursor is selected.

(22)-12 Call other cursor

Upon execution, the cursor not displayed (A or B) is moved to the center (the location where the data is) of the screen.

(23) Data search

Moves the cursor to the position that satisfies the set conditions.



Item select		Examples of item	
(23)-1	Channel type	Analog, Pulse, Logic, Alarm	
(23)-2	Channel	1 to 112CH * This varies depending on the channel type.	
(23)-3	Mode	[Analog]	H, L
		[Pulse]	
		[Logic]	Both, H, L
		[Alarm]	
(23)-4	Level	Numeric input	
(23)-5	Prev. search	▷ Execute	
(23)-6	Next search	▷ Execute	

(23)-1 Channel type

Set the channel type to search.

(23)-2 Channel

Set which channel to use for searching. The only channels that can be set are the channels corresponding to the types selected in "(23)-1 Channel type".

(23)-3 Mode

<In case of Analogue/Pulse/Logic>

Item select	Description
H	Captures the rising edge of a specified CH.
L	Captures the falling edge of a specified CH.

<In case of alarm>

Item select	Description
Both	Searches the alarm output either as it changes to established or cleared.
H	Searches the alarm output edge that changes from being cleared to being established.
L	Searches the alarm output edge that changes from being cleared to being established.

(23)-4 Level

Specify the retrieved voltage level when the searched channel type is analogue or pulse.

(23)-5 Prev. search

Upon execution, the cursor is moved to the position previous to the current position, and a position that satisfies the search conditions. (Please set the retrieval conditions in "(23)-3 Mode" and "(23)-4 Level".)

(23)-6 Next search

Upon execution, the cursor is moved to the position following the current position, and a position that satisfies the search conditions. (Please set the retrieval conditions in "(23)-3 Mode" and "(23)-4 Level".)

(24) Action screen

The recorded data can be saved and shown in the XY or FFT display.

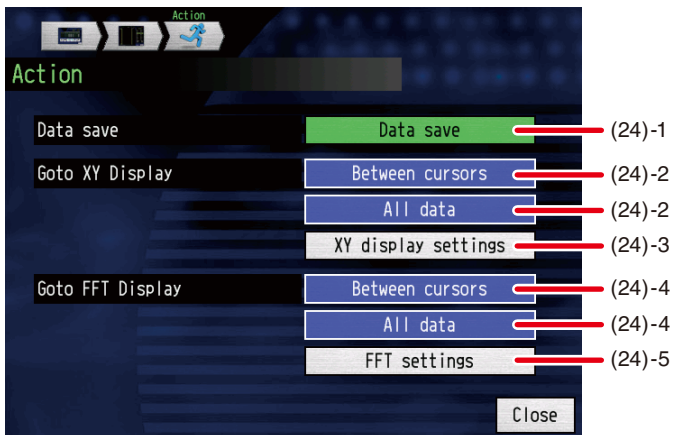

Select items	Description
(24)-1	Use the "Data save" to save the recorded data (See page 3-153).
(24)-2	Use these buttons to display the Y-T display data between the cursors or all the data with the XY display (See page 3-139).
(24)-3	Use the "XY display settings" to perform the XY display settings (See page 3-144). Always set them before X-Y display of the setting item (24)-2.
(24)-4	Use these buttons to perform FFT analysis between the cursors or within the selected range of all the data (See page 3-145).
(24)-5	Use the "FFT settings", perform the FFT settings (See page 3-145). Always set then before FFT analysis of the setting item (24)-4.

* When you want to Y-T display after starting up the setting times (24)-2 and (24)-4, return to Action screen and then start up the "Goto Y-T Display"

(27) Output settings (DCO module settings)

Set the analog voltage output to the equipment to be received.

("Home" → "GL7000 setting" → "Data settings" → "Output settings" → "DCO module settings")

("Home" → "GL7000 setting" → "DCO module settings")

<Voltage Output Module (GL7-DCO)>

For the setting procedure for this module, refer to (4) Output settings in "3.6 Settings menu".

(The number in the following figure is expressed in the same number as the number of (4) Output settings in "3.6 Settings menu".)

<Output settings → DCO module settings>

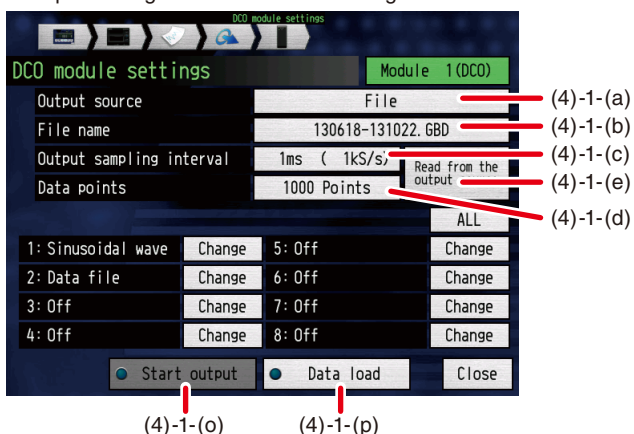

<When using Sine wave, Triangle wave, Ramp wave>



<When using Pulse wave>

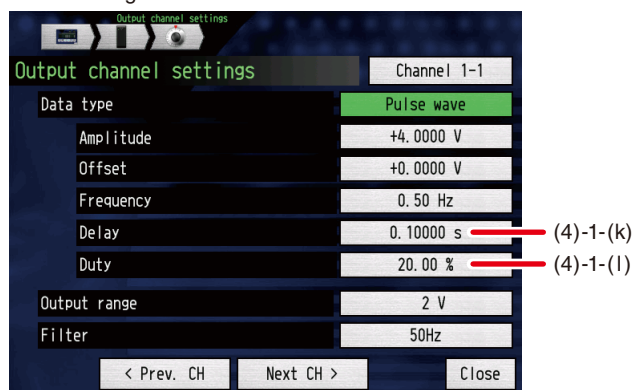

Item select		Examples of item	
(4)-1	(a)	Output source	Built-in RAM, File
	(b)	File name	File selection
	(c)	Output sampling interval	10ms (100kS/s), 20ms (50kS/s), 50ms (20kS/s), 100ms (10kS/s), 200ms (5kS/s), 500ms (2kS/s), 1ms (1kS/s), 2ms (500S/s), 5ms (200S/s), 10ms (100S/s), 20ms (50S/s), 50ms (20S/s), 100ms (10S/s), 125ms (8S/s), 200ms (5S/s), 250ms (4S/s), 500ms (2S/s), 1s (1S/s), 2s, 5s, 10s, 20s, 30s, 1min, 2min, 5min, 10min, 20min, 30min, 1h
	(d)	Data points	1 to 128,000,000 points
	(e)	Read from the output source	Reading the file data conditions

Item select		Examples of item	
(f)	Setting (ALL, 1CH to 8CH)	Data type	Off, Data file, DC, Sine wave, Triangle wave, Ramp wave, Pulse wave
(g)		Amplitude	0.000 to +20.000V
(h)		Offset	-10.000 to +10.000V
(i)		Frequency	0.00 to 10,000.00Hz
(j)		Phase	-360.0 to +360.0deg.
(k)		Delay	0.00000 to 100.00000sec.
(l)		Duty	0.00 to 100.00%
(m)		Output range	1, 2, 5, 10V
(n)		Filter	Off, Line, 5 / 50 / 500Hz, 5 / 50kHz
(o)	Data load	Reading the analog voltage output data and conditions	
(p)	Start output	Analog voltage output start / output stop	

⚠ CAUTION

Before operating the Start output, the following setting conditions must be set on the Output settings screen. (For details, refer to (4) Output settings in "3.6 Settings menu" on page 3-77.)

- Start / Stop synchronization
- Repeat output
- Emergency stop alarm CH
- Output level at the time of Stop

When the Output level at the time of Stop is set to "Retain", the voltage value at the time of stop is output.

3.7 Web server functions

Operation and monitoring of the GL7000 can be done with a web browser.

● Supported web browsers

- Microsoft Internet Explorer 6.0 or later
- Netscape 6.2 or later
- Firefox 1.5 or later
- Opera 9.0 or later

● Functions carried out through web browsers

- Operating of GL7000
- Monitoring of GL7000's screen
- Magnified view of GL7000's display screen
- Link to the FTP
- Link to our website

● URL settings

Set the URL (Uniform Resource Locator) appropriately, according to the network environment in use. By setting as follows, the GL7000 can be accessed.

http://IP address/index.html

- http Protocol for accessing the server.
HTTP (Hyper Text Transfer Protocol)
- IP address Input the address of the monitoring GL7000
- index.html A file name. It's fixed as index.html

CHECKPOINT

- The port number can be omitted. If inputting, please set it to 80.
http://IP address:80/index.html
- WEB connections from multiple browsers can not occur. Please use 1 browser connection for each machine.

● Operation procedure

- (1) Start a web browse



(2) Enter in an URL (http://IP address/index.html) in the address field.

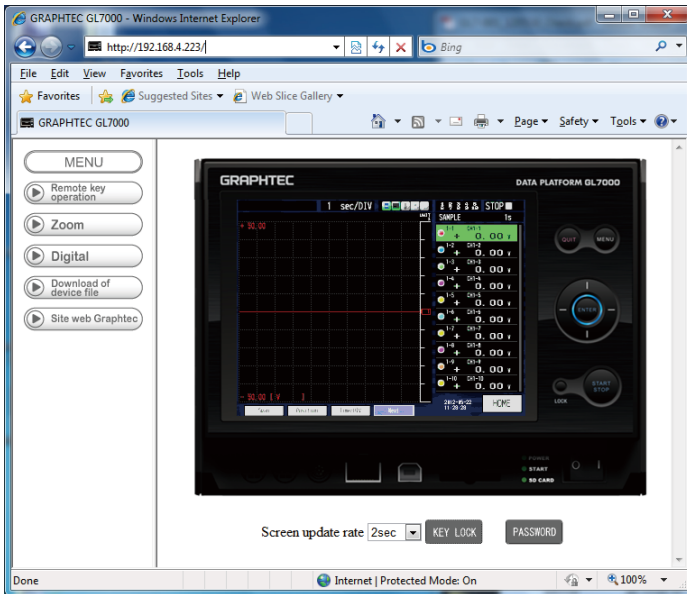

Remote key operation....GL7000 operations can be performed.

Zoom.....Only for zooming in on the LCD screen of the GL7000.

Digital.....Digital display of the GL7000 measurement value.

Download of device file

.....Using the FTP function to download data recorded with the GL7000 to the PC.

Site web GraphtecLinks to our company's homepage.

● Remote operations

The GL7000 can be remotely operated by clicking on the GL7000 operation key part or the button on the screen.



KEY LOCK.....Carries out key-lock and clears it.

PASSWORDClears password settings.

Screen update rateSets the refreshing rate of the screen.

The screen refresh rate can be set to 2, 5, 10 seconds.

● Screen display



Screen update rateSet the refreshing rate of the screen.
The screen refresh rate can be set to 2, 5, 10 seconds.

● Digital screen

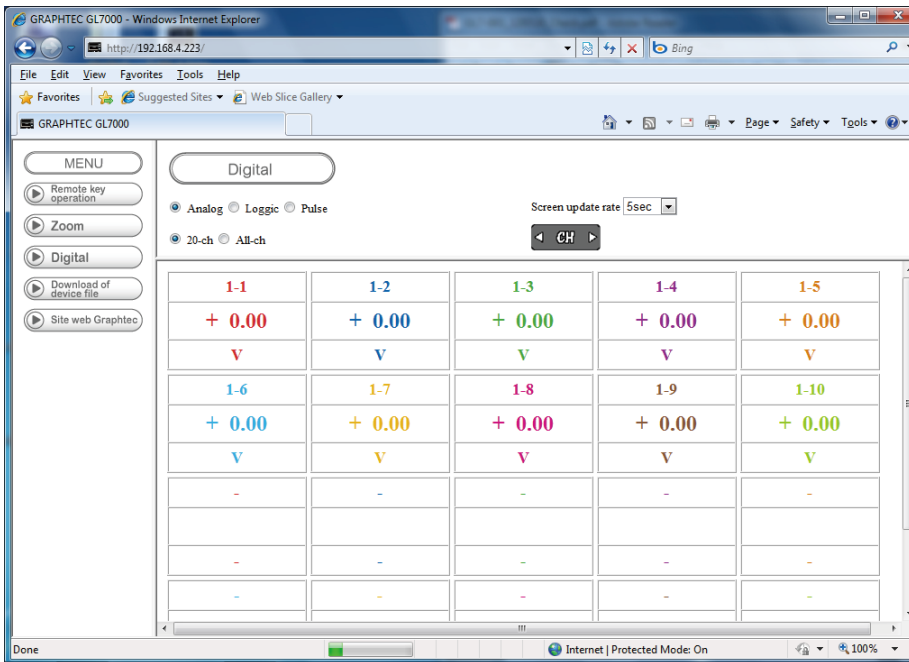

Screen update rateSet the refreshing rate of the screen.
The screen refresh rate can be set to 2, 5, 10 seconds.

● Downloading GL7000 files

GL7000 memory data, SD card data, and SSD data can be downloaded to PC.

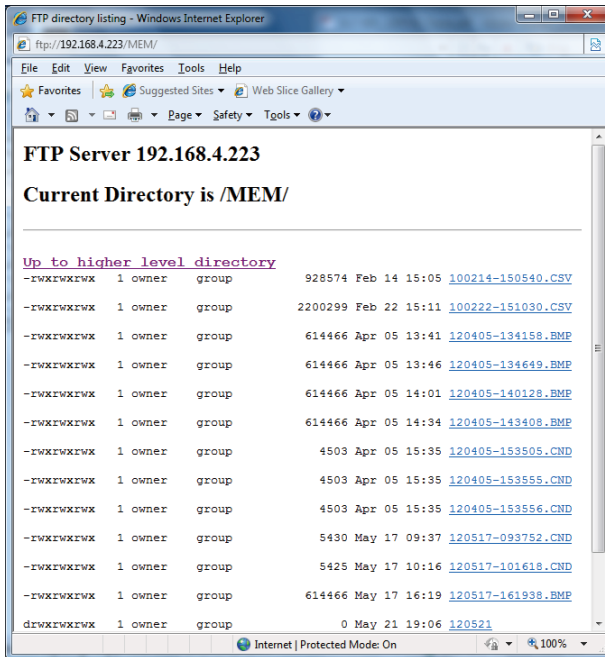

<FTP server functions>

When connection to FTP with Internet Explorer, because you're automatically logged in as anonymous it's limited to read-only.

When limited to read-only, the following operations can not be performed.

- Upload data
- Delete files/folders
- Create files/folders
- Change File name/folder name

For writing to the GL7000, the login account must be changed.

For account name and password, refer to the following.

Account name	Password	Restrictions
GL7000	N/A	N/A
gl7000	N/A	N/A
Anonymous	Optional	Read-only

For updating the login account, perform the following operations.

<When using Internet Explorer 6>

Open the "Log On As" dialogue via "File" → "Login As...".

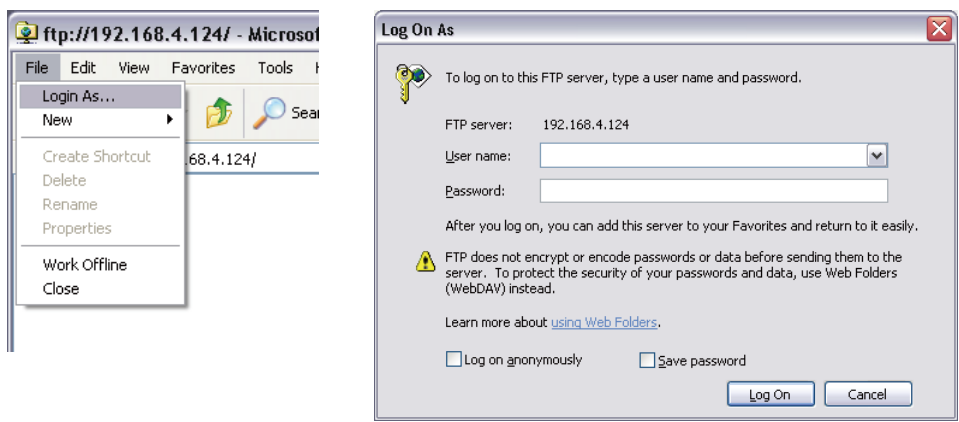

Enter the account name in user name field. Leave the password field blank. Finally, press the "Log on" button.

<When using Internet Explorer 8>

Open Internet options via "Tools" → "Internet Options".

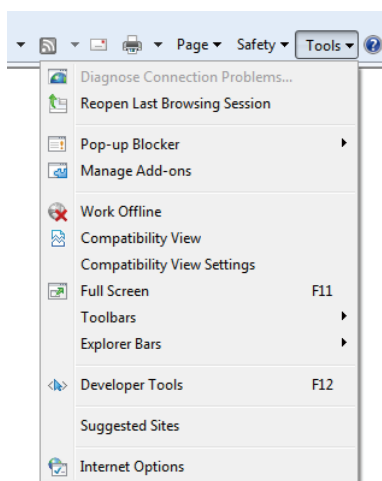

Select "Advanced" tab and check "Enable FTP folder view (Outside Internet Explorer)"

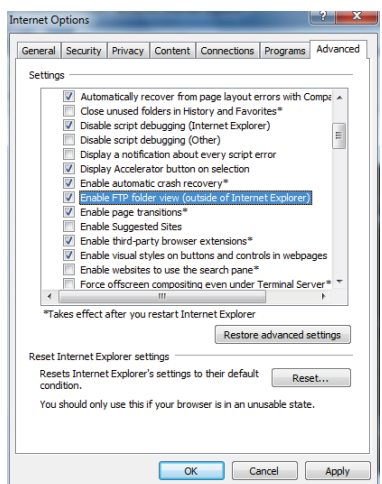

Press the "OK" button to close the Internet option dialogue.
Close Internet Explorer.

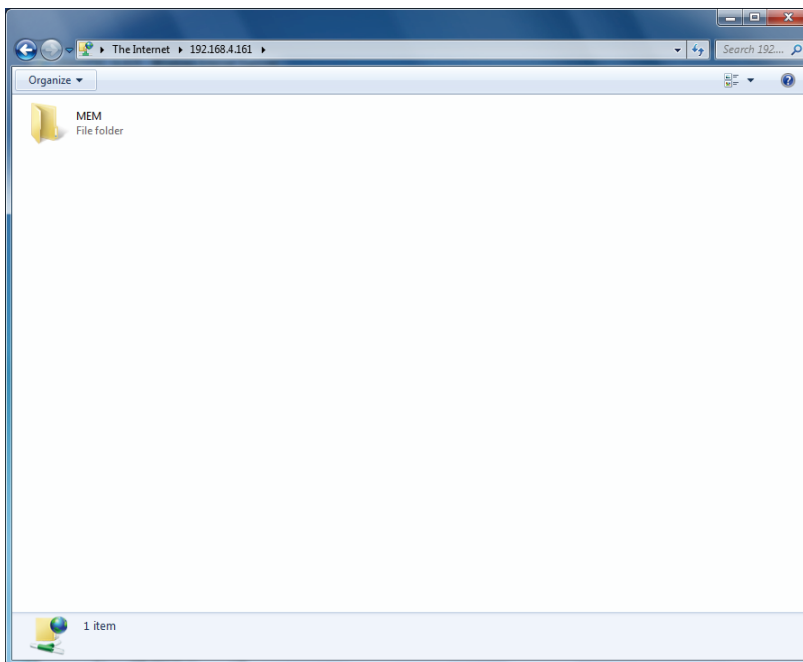

Open the "Log On As" dialogue via "File" → "Login As..".

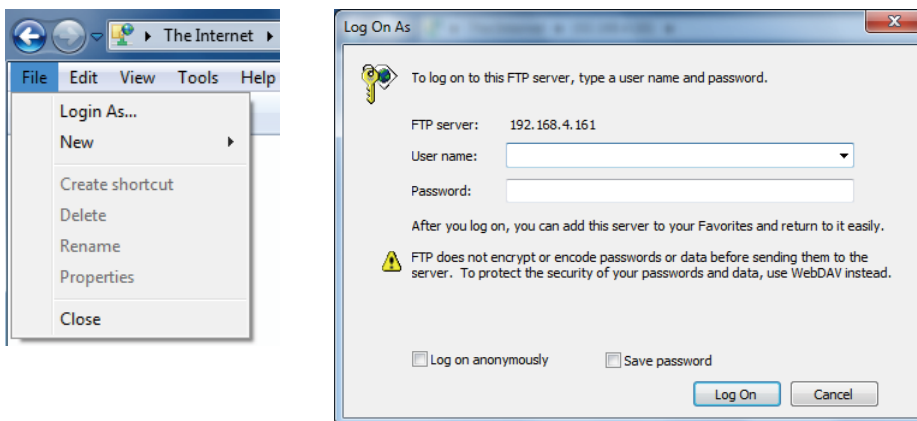

Enter the account name in user name field. Leave the password field blank.
Finally, press the "Log On" button.

CHECKPOINT

- If the "File" menu is not displayed in Explorer, check "Edit" → "Layout" → "Menu bar" to display the menu.
- If FTP is used when the number of capturing channels is larger or sampling is faster, writing of captured data may be delayed and data may be lost.

CHAPTER 4 Specification

This chapter describes the basic specifications for the GL7000.

PRODUCT SUMMARY

- 4.1 Standard Specifications
- 4.2 Function Specifications
- 4.3 Function Module Specifications
- 4.4 Amplifier Module Specifications
- 4.5 Accessory/Option Specifications
- 4.6 Accessories
- 4.7 External view

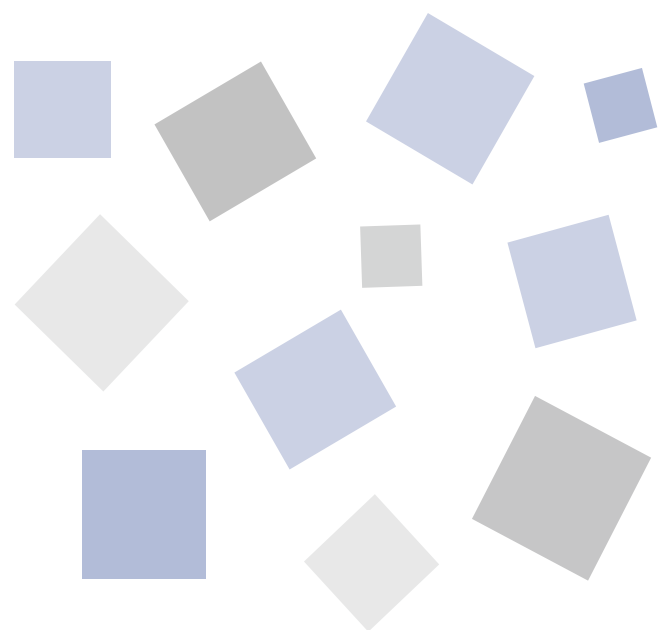

4.1 Standard Specifications

Standard Specifications

Item	Description
Number of Amplifier Modules	Max. 10 modules * The DC strain module can be installed up to 8 modules. * Function Modules like the Display Module and the SSD Module are not included in the 10 Modules mentioned above. * The Logic/Pulse amplifier can be set to either logical amplifier or pulse amplifier. The pulse amplifier can only be set for up to 2 modules (16ch/1 module).
External input/output	Start/Stop input, External trigger input, External sampling input, Trigger output. * When using the external input/output function, the I/O cable B-513 (optional) for GL series is required.
Alarm input/output	10ch * The Alarm Module is a separate module from the main module.
PC I/F	Ethernet (10BASE-T/100BASE-TX), USB2.0 (compatible with high-speed), standard-included
Internal memory device	Built-in flash memory: approx. 4GB * The built-in RAM is equipped with standard in each Amplifier Module, which can be stored 2,000,000 data. Synchronization function is available in GL-Connection only.
External memory device	SD card (SDHC equivalent, maximum approx. 32GB) slot standard-included
Backup function	Setting Conditions: EEPROM/Clock: Lithium secondary battery
Clock accuracy (23°C environment)	±0.002% (approx. 50 seconds per month)
Synchronization between measurement modules	With Start and Trigger synchronizing functions * When using the synchronizing function, the optional coaxial cable B-559 is required. The synchronizing function is available in the GL-Connection only.
Time base accuracy	±100ppm (23°C±2°C)
Usage environment	0 to 45°C, 5 to 85% R.H.
Withstand voltage	Between AC power and housing: 1500 VAC at 1 minute
Insulation resistance	Between AC power and housing: 500 VDC at 20MΩ or more
Power supply	AC input: 100 to 240 V AC/50 to 60Hz
Power consumption	Maximum 110VA (AC 240V)
External dimension (approx.) [W × H × D]	Main modle: 193 × 141 × 160 mm (not including protruding parts) Alarm Module: 30 × 136 × 145 mm (not including protruding parts)
Weight (approx.)	Main modle: 2.2 kg Alarm Module: 350 g
Others	Vibration proof: Automobile parts Type 1 Class A equivalent

List of power consumption for each unit

Unit	Power consumption (VA)	
	100V	240V
GL7000	10.0	23.0
GL7000-DISP	4.0	3.5
GL7000-SSD	4.0	3.5
GL7000-V	5.5	5.0
GL7000-HSV	3.5	3.2
GL7000-M	2.5	2.3
GL7000-LP	2.5	2.3
GL7000-HV	4.0	3.8
GL7000-DCB	8.4	8.2
GL7000-CHA	7.4	7.2
GL7000-DOC	6.6	6.4

Internal memory devices

Item	Description
Memory capacity	Built-in RAM: SD-RAM, 2,000,000 data (equipped with each Amplifier Module) SSD* ¹ : approx. 128GB (However, one file must be 4GB at the maximum) Built-in flash memory: Flash memory, 4GB (However, one file must be 4GB at the maximum.) SD card: Compatible with SDHC, maximum approx. 32GB (However, one file must be 4GB at the maximum) * Depending on the recording destination there is a limit to the sampling interval.
Memory contents	Built-in RAM: Measured data SSD* ¹ : Measured data, main module setting Conditions, Screen copy Built-in flash memory: Measured data, main module setting Conditions, Screen copy SD card: Measured data, main module setting Conditions, Screen copy

*1: SSD Module (sold separately), GL7-SSD (optional) are required.

There is a limit to the highest sampling rate can be set for the number of modules to be used.

When setting the sampling interval to 1 μ s, 2 μ s and 5 μ s, there is a limit to the number of pulse input channels. (For details, see "(1)-2 Sampling Interval" in page 3-62.)

PC I/F

Item	Description
Interface types	Ethernet (10BASE-T/100BASE-TX) USB (High-speed)
Software functions	Data transfer to the PC (real-time memory) PC control of the main module
Ethernet functions (10BASE-T/100BASE-TX)	Web server functions: Displays the screen images of main module FTP server functions: SSD* ¹ , Built-in flash memory, Transfers and deletes files from the SD card memory. FTP client functions: Backup captured data to FTP server NTP client functions: Time synchronization with the NTP server. DHCP client functions: IP address automatic acquisition
USB functions	USB drive mode: SSD* ¹ , Built-in flash memory, Transfers and deletes of files from the SD card memory. * By flipping the machine slide switch, or turning on the power while pressing the [Start/ Stop] key on the Display Module, it goes into USB Drive Mode.
Real-time data transfer speed* ²	1 msec/5 Amplifier unit as a guide

*1: SSD Module (sold separately), GL7-SSD (optional) are required.

*2: It depends on connection environment.

Item	Description
Functions during capture ^{*3}	Double-screen display Exchange of SD card Saving of data between cursors
Data save functions	Capture to built-in RAM Capture to SSD ^{*1} (Limited to sampling interval) Capture to built-in flash memory (Limited to sampling interval) Capture to SD card (SSD ^{*1} , built-in flash memory, SD card) Save setting data (SSD ^{*1} , built-in flash memory, SD card) Copy of data screen can be saved (SSD ^{*1} , built-in flash memory, SD card)
Data backup function	Backup interval : OFF, 1, 2, 6, 12, 24 hours Backup destination : SD card, SSD ^{*1} , FTP * The recording destination and backup destination cannot be specified to the same location.

*1: SSD Module (sold separately), GL7-SSD (optional) are required.

*2: There is a limit to the highest sampling rate can be set for the number of modules to be used. When using the High
When setting the sampling interval to 1 μ s, 2 μ s and 5 μ s, there is a limit to the number of pulse input channels. (For details, see "(1)-2 Sampling Interval" in page 3-62.)

*3: When the sampling interval is less than 100 ms, this function is not available.
This function cannot be used in recording with the built-in RAM.
When recording in CSV format, this function is not available.
(However, the SD card can be replaced even if recorded in CSV format.)

Trigger and Alarm functions

Item	Description
Repeat Trigger	OFF, ON
Trigger types	Start : Data capture starts when a trigger is generated. Stop : Data capture stops when a trigger is generated.
Trigger conditions	Start : Off, Level, Alarm, External, Time, Date, Weekly Stop : Off, Level, Alarm, External, Time, Date, Weekly
Level trigger judgment modes	Combination : Level OR, Level AND, Edge OR, Edge AND Analog channel judgment mode : H (↑), L (↓), Window In, Window Out Logic channel judgment mode : H (↑), L (↓) Pulse channel judgment mode : H (↑), L (↓), Window In, Window Out
Alarm judgment modes	Detection method : Level OR, Level AND, Edge OR, Edge AND Analog channel judgment mode : H (↑), L (↓), Window In, Window Out Logic channel judgment mode : H (↑), L (↓) Pulse channel judgment mode : H (↑), L (↓), Window In, Window Out Detection cycle Voltage/Temperature amplifier : when the sampling speed is 5 seconds or more, the alarm is detected in 5 second intervals. When the sampling interval is less than 5 seconds, the alarm is detected at the sampling speed. Other amplifiers : The sampling rate is detected in 1 ms intervals for less than 1 ms. The sampling rate is detected in sampling rate between 2 ms and 5 sec. The sampling rate is detected in 5 sec. intervals for 5 sec. or more.
Pre-trigger	Number of specified points: 0 to the number of recordings. * This function is only possible when the recording destination is the built-in RAM. * Depending on the trigger combination, there may be cases where the pre-trigger cannot be used.

Various functions

Item	Description
Display	Analog waveforms, logic waveforms, pulse waveforms, digital values
Display modes	Y-T View (Digital display), X-Y View (Digital display), FFT View, Cursor Information View, Recorded Data View, Alarm Information View
EU (Scaling function)	Analog ch (Voltage Channel) : Each ch, 4-point setting Analog ch (temperature ch) : Each ch, 2-point setting (offset setting) Pulse ch : Each ch, 2-point setting (gain setting) Characters available : Alphabet, numbers, and other (μ and , etc.)
Calculation between Channels	Calculation type : Addition, subtraction, multiplication, and division Input target : Analog channels 1 through 100 Output target : Analog channels 1 through 100 * The fastest sampling interval that can be used for the Calculation between Channels function is 100 ms.
Statistical calculation	Types of operation : Average value, peak value, maximum value, minimum value Number of operations : maximum of 2 can be set simultaneously Calculation method : Real-time calculation and calculation between cursors (during replay) * Real-time calculation results are displayed in the Digital + Calculation Display screen.
Move functions	Type of moving : Move to first, Move to last, Move to center, Move to trigger, Move to selected position, Call other cursor.
Search functions	Function : Search the captured data for the required number of points Search Channel: Analog, Pulse, Logic, Alarm
Annotation input function	Function : A comment can be input for each channel Inputtable characters : Alphanumerics Number of characters: 31 half-width characters
Message/Marker functions	Function : The registered messages are recorded for any timing. Number of registration messages: Max. 8 Message : Unspecified message is input before or during recording Marker : alarm, blackout
Resume functions	Function : If the power goes off and is returned during data recording, recording will start again from the conditions that were present before the power went off. When GL7000 is in FFT mode or the Voltage Output Module is used, this function is not enabled. Users must be operated manually in each case.
FFT function	Analysis frequency : 0.08, 0.2, 0.4, 1.6, 2, 3.2, 4, 8, 2, 40, 80, 200, 400, 800Hz, 2, 4, 8, 20, 40, 80, 200, 400kHz Number of analysis points : 500, 1000, 2000, 4000, 10000 Time window : Rectangular, Hanning, Hamming, Blackman, Flattop, Exponential Average mode : Summation, Exponential, Peak hold Analysis CH : 4-ch Analysis function : Y-T, Linear, Power, PSD, Cross, TRF, Coherence, COP Display : 1-divided, 2-divided, Nyquist

External Input/Output functions

Item	Description
Input/output types	<ul style="list-style-type: none"> • Start/Stop input (1ch) • External trigger input (1ch) • External sampling input (1ch) • Trigger input (1ch) • Alarm output (10ch) • Auto-balancing input (1ch) • BUSY signal output (1ch) <p>* The Start/Stop input is performed at a level action. * For input/output other than alarm output, the output cable B-513 (optional) for GL series is necessary. * The alarm output is attached to the included Alarm Module. * When the DC strain module is installed, the auto-balancing input and BUSY signal output are performed.</p>
Input specifications	<p>Max. input voltage : 0 to +24 V (single-ended ground input) Input signal : Non-voltage contact (a contact, b contact, NO, NC), Open collector, Voltage input Input threshold voltage: approx. +2.5 V Hysteresis : approx. 0.5 V (+2.5 to + 3 V) * For more information about the output circuit, see page 2-46.</p>
Alarm output specifications	<p>Output form: Open collector output (pull-up resistance 10kΩ) <Maximum rating of the output transistor></p> <ul style="list-style-type: none"> • Voltage between collector and GND: 50 V • Collector current : 2.0 A • Collector dissipation : 0.6 W <p>* This specification is a maximum rating of the transistor used in the output circuit. When using this, ensure that the margin is sufficient. For details on the output circuit, see page 2-46.</p>
External sampling input	<p>Max. input frequency Built-in RAM : 1 MHz SSD*¹ recording : 1 kHz Built-in flash memory recording : 1 kHz SD card recording : 1 kHz Temporal error : Depending on each amplifier specifications * Until the maximum sampling interval is reached for each amplifier errors may appear.</p>

*1: SSD Module (sold separately), GL7-SSD (optional) are required.

There is a limit to the highest sampling rate can be set for the number of modules to be used.

When setting the sampling interval to 1 μs, 2 μs and 5 μs, there is a limit to the number of pulse input channels. (For details, see "(1)-2 Sampling Interval" in page 3-62.)

Synchronization function

Item	Description
Synchronization function	<ul style="list-style-type: none"> • Synchronizes the Start/Stop, trigger, and sampling between multiple units. • By connecting a sync cable, Base/Remote is automatically identified. • Part of the function for the Start/Stop switch and trigger combination etc. are only valid for the base unit. • The number of Amplifier Modules that can be connected to the base and remote unit conform to the basic specifications.
Number of synchronization	Max. 5 units
Cable	Sync cable, B-559 (optional)

* Synchronization function is available in GL-Connection only.

4.3 Function Module Specifications

Display Module (GL-DISP: optional)

Item	Description
Monitor	5.7" TFT color liquid crystal display (VGA: 640 × 480 dot)
Operating portion	Capacitive touch-panel and key shared use * Almost all operations can be performed by either the touch-panel or the keys.
Touch-panel	Input method: Finger or "electrostatic" special pen
Display character	Japanese, English, French, German, Chinese, Korean
Backlight life	50,000 hours (when brightness has decreased to 40%), changes according to use environment.
Backlight	Screen saver function (10, 30 sec.; 1, 2, 5, 10, 30, 60 min.)
Display screen	Waveform + digital screen, full waveform screen, digital + operation screen, X-Y display
Connection cable	LAN cable (Straight, CAT5 or above, Cable length:10 m or less) * Please purchase a commercially available product.
Accessories	Tilting table: 1 unit, Monitor connection cable: 1 pc., Screws (M4 × 6): 3 pcs. Flat head screws (M4 × 10): 2 pcs. (Spare), Ground cable: 1 pc.
External dimensions (approx.) [W × D × H]	187 × 34.5 × 119 mm (Not including protruding parts)
Weight (approx.)	530 g

* Since the touch-panel in this main module is a capacitive touch-panel, it does not respond by touching it with a pen. Touch with your fingers without glove.

* Please note that if the touch-panel is operated with an object with a sharp edge, it may scratch and damage the touch-panel.

* Do not touch when your hands are wet.

SSD Module (GL7-SSD: optional)

Item	Description
SSD	2.5-inch SSD HDD (SATA I/F)
Recording capacity	Approx. 128GB (However, 1 file can be up to 4GB in size)
Sampling interval	Module 1 to 2 : 1 μsec fastest Module 3 to 4 : 2 μsec fastest Module 5 to 10: 5 μsec fastest * Depending on the amplifier in use, there may be limitations to the sampling interval. It is limited to the furthest amplifier in use. * There is a limit to the highest sampling rate can be set for the number of modules to be used. When setting the sampling interval to 1 μs, 2 μs and 5 μs, there is a limit to the number of pulse input channels. (For details, see "(1)-2 Sampling Interval" in page 3-62.)
External dimensions (approx.) [W × D × H]	49.2 × 136 × 160 mm (Not including protruding parts)
Weight (approx.)	770 g
Vibration proof	Automobile parts Type 1 Class A equivalent

4.4 Amplifier Module Specifications

Voltage Module (For voltage measurement) (GL7-V: optional)

Item	Description
Number of input channels	10 channels/1 module
Input terminal shape	M3 screw type terminal
Input method	All-ch insulation, simultaneous sampling, unbalanced input
Sampling interval	1 ms fastest
Built-in RAM	2,000,000 data
Measurement range	Voltage: 100, 200, 500 mV, 1, 2, 5, 10, 20, 50, 100, 1-5V.F.S.
Measurement accuracy (23 ±5°C) • 30 minutes or more after power-up • Filter Line • GND connection	Voltage: ±0.25% of F.S.
A/D converter	System : Sequential comparison system Resolution: 16-bit (Effective ability: approximate ± range 1/40,000)
Temperature coefficient	Gain: ±0.01% of F.S./°C Zero: ±0.02% of F.S./°C
Input resistance	1 MΩ ±5%
Input signal source resistance	1 kΩ or less
Maximum input voltage	Input terminal +/– interval: 100 mv to 1 V range → 60 Vp-p : 2 V to 100 V range → 100 Vp-p Input terminal (-)/Input terminal (-) interval: 60 Vp-p Input terminal (-)/GND terminal interval : 60 Vp-p * For details, see page 2-30.
Withstand voltage	Input terminal (-)/Input terminal interval : 1000Vp-p for 1 minute Input terminal (-)/GND terminal interval : 1000Vp-p for 1 minute * For details, see page 2-30.
Insulation resistance	Input terminal (-)/GND terminal interval: 50 MΩ or more (at 500 VDC)
Common mode rejection	90 dB or more (50/60 Hz signal source 300 Ω or less)
S/N (Noise)	48 dB or more (+/– at short)
Frequency response	DC to 1 kHz (+1, -3 dB)
Filter	L.P.F. : OFF, Line (1.5 Hz), 5 Hz, 50 Hz, 500 Hz Attenuation: -3 dB (-5.2 dB to -1.4 dB)/6 dB oct
External dimensions (approx.) [W × D × H]	49.2 × 136 × 160 mm (Not including protruding parts)
Weight (approx.)	840 g

Voltage/Temperature Module (For temperature measurement) (GL7-M: optional)

Item	Description																																																																		
Number of input channels	10 channels/1 module																																																																		
Input terminal shape	M3 screw type terminal																																																																		
Input method	All-ch insulation, Scan method, Balanced input * All CH of the b terminal used when using the resistance bulb are all connected internally.																																																																		
Sampling interval	10 ms fastest																																																																		
Built-in RAM	2,000,000 data																																																																		
Measurement range	<ul style="list-style-type: none"> Voltage: 20, 50, 100, 200, 500 mV, 1, 2, 5, 10, 20, 50, 1-5 VF.S. Temperature <ul style="list-style-type: none"> Thermocouple: K, J, E, T, R, S, B, N, C (WRe5-26) Resistance Temperature Detector: Pt100, JPt100, Pt1000 (IEC751) Humidity: 0 to 100% R.H. (Voltage 0 to 1 V scaling conversion) * See B-530 (optional)																																																																		
Measurement accuracy (23 ±5°C) <ul style="list-style-type: none"> 30 minutes or more after power-up Sampling 1 s Filter ON (10) GND connection 	Voltage: ±0.1% of F.S. Temperature <ul style="list-style-type: none"> Thermocouple <table border="1"> <thead> <tr> <th>Thermocouple</th> <th>Measurement temperature range (°C)</th> <th>Measurement accuracy</th> </tr> </thead> <tbody> <tr> <td rowspan="4">R/S</td> <td>0 ≤ TS ≤ 100</td> <td>±5.2°C</td> </tr> <tr> <td>100 < TS ≤ 300</td> <td>±3.0°C</td> </tr> <tr> <td>R: 300 < TS ≤ 1600°C</td> <td>± (0.05% of rdg +2.0°C)</td> </tr> <tr> <td>S: 300 < TS ≤ 1760°C</td> <td>± (0.05% of rdg +2.0°C)</td> </tr> <tr> <td rowspan="2">B</td> <td>400 ≤ TS ≤ 600</td> <td>±3.5°C</td> </tr> <tr> <td>600 < TS ≤ 1820°C</td> <td>± (0.05% of rdg +2.0°C)</td> </tr> <tr> <td rowspan="2">K</td> <td>-200 ≤ TS ≤ -100</td> <td>± (0.05% of rdg +2.0°C)</td> </tr> <tr> <td>-100 < TS ≤ 1370°C</td> <td>± (0.05% of rdg +1.0°C)</td> </tr> <tr> <td rowspan="2">E</td> <td>-200 ≤ TS ≤ -100</td> <td>± (0.05% of rdg +2.0°C)</td> </tr> <tr> <td>-100 < TS ≤ 800°C</td> <td>± (0.05% of rdg +1.0°C)</td> </tr> <tr> <td rowspan="2">T</td> <td>-200 ≤ TS ≤ -100</td> <td>± (0.1% of rdg +1.5°C)</td> </tr> <tr> <td>-100 < TS ≤ 400°C</td> <td>± (0.1% of rdgv0.5°C)</td> </tr> <tr> <td rowspan="3">J</td> <td>-200 ≤ TS ≤ -100</td> <td>±2.7°C</td> </tr> <tr> <td>-100 < TS ≤ 100</td> <td>±1.7°C</td> </tr> <tr> <td>100 < TS ≤ 1100°C</td> <td>± (0.05% of rdg +1.0°C)</td> </tr> <tr> <td rowspan="2">N</td> <td>0 ≤ TS ≤ 1300°C</td> <td>± (0.1% of rdg +1.0°C)</td> </tr> <tr> <td>-200 ≤ TS < 0°C</td> <td>± (0.1% of rdg +2.0°C)</td> </tr> <tr> <td>C (W)</td> <td>0 ≤ TS ≤ 2000°C</td> <td>± (0.1% of rdgv1.5°C)</td> </tr> <tr> <td colspan="2">Reference junction compensation accuracy</td> <td>±0.5°C</td> </tr> </tbody> </table> <p>* Use the thermocouple (T: 0.32), otherwise use 0.65</p> <ul style="list-style-type: none"> Resistance Temperature Detector <table border="1"> <thead> <tr> <th>Types</th> <th>Measurement temperature range (°C)</th> <th>Impressed current</th> <th>Measurement accuracy</th> </tr> </thead> <tbody> <tr> <td>Pt100</td> <td>-200 to 850 (F.S.=1050°C)</td> <td>1 mA</td> <td>±1.0°C</td> </tr> <tr> <td>JPt100</td> <td>-200 to 500 (F.S.=700°C)</td> <td>1 mA</td> <td>±0.8°C</td> </tr> <tr> <td>Pt1000</td> <td>-200 to 500 (F.S.=700°C)</td> <td>0.2 mA</td> <td>±0.8°C</td> </tr> </tbody> </table>	Thermocouple	Measurement temperature range (°C)	Measurement accuracy	R/S	0 ≤ TS ≤ 100	±5.2°C	100 < TS ≤ 300	±3.0°C	R: 300 < TS ≤ 1600°C	± (0.05% of rdg +2.0°C)	S: 300 < TS ≤ 1760°C	± (0.05% of rdg +2.0°C)	B	400 ≤ TS ≤ 600	±3.5°C	600 < TS ≤ 1820°C	± (0.05% of rdg +2.0°C)	K	-200 ≤ TS ≤ -100	± (0.05% of rdg +2.0°C)	-100 < TS ≤ 1370°C	± (0.05% of rdg +1.0°C)	E	-200 ≤ TS ≤ -100	± (0.05% of rdg +2.0°C)	-100 < TS ≤ 800°C	± (0.05% of rdg +1.0°C)	T	-200 ≤ TS ≤ -100	± (0.1% of rdg +1.5°C)	-100 < TS ≤ 400°C	± (0.1% of rdgv0.5°C)	J	-200 ≤ TS ≤ -100	±2.7°C	-100 < TS ≤ 100	±1.7°C	100 < TS ≤ 1100°C	± (0.05% of rdg +1.0°C)	N	0 ≤ TS ≤ 1300°C	± (0.1% of rdg +1.0°C)	-200 ≤ TS < 0°C	± (0.1% of rdg +2.0°C)	C (W)	0 ≤ TS ≤ 2000°C	± (0.1% of rdgv1.5°C)	Reference junction compensation accuracy		±0.5°C	Types	Measurement temperature range (°C)	Impressed current	Measurement accuracy	Pt100	-200 to 850 (F.S.=1050°C)	1 mA	±1.0°C	JPt100	-200 to 500 (F.S.=700°C)	1 mA	±0.8°C	Pt1000	-200 to 500 (F.S.=700°C)	0.2 mA	±0.8°C
Thermocouple	Measurement temperature range (°C)	Measurement accuracy																																																																	
R/S	0 ≤ TS ≤ 100	±5.2°C																																																																	
	100 < TS ≤ 300	±3.0°C																																																																	
	R: 300 < TS ≤ 1600°C	± (0.05% of rdg +2.0°C)																																																																	
	S: 300 < TS ≤ 1760°C	± (0.05% of rdg +2.0°C)																																																																	
B	400 ≤ TS ≤ 600	±3.5°C																																																																	
	600 < TS ≤ 1820°C	± (0.05% of rdg +2.0°C)																																																																	
K	-200 ≤ TS ≤ -100	± (0.05% of rdg +2.0°C)																																																																	
	-100 < TS ≤ 1370°C	± (0.05% of rdg +1.0°C)																																																																	
E	-200 ≤ TS ≤ -100	± (0.05% of rdg +2.0°C)																																																																	
	-100 < TS ≤ 800°C	± (0.05% of rdg +1.0°C)																																																																	
T	-200 ≤ TS ≤ -100	± (0.1% of rdg +1.5°C)																																																																	
	-100 < TS ≤ 400°C	± (0.1% of rdgv0.5°C)																																																																	
J	-200 ≤ TS ≤ -100	±2.7°C																																																																	
	-100 < TS ≤ 100	±1.7°C																																																																	
	100 < TS ≤ 1100°C	± (0.05% of rdg +1.0°C)																																																																	
N	0 ≤ TS ≤ 1300°C	± (0.1% of rdg +1.0°C)																																																																	
	-200 ≤ TS < 0°C	± (0.1% of rdg +2.0°C)																																																																	
C (W)	0 ≤ TS ≤ 2000°C	± (0.1% of rdgv1.5°C)																																																																	
Reference junction compensation accuracy		±0.5°C																																																																	
Types	Measurement temperature range (°C)	Impressed current	Measurement accuracy																																																																
Pt100	-200 to 850 (F.S.=1050°C)	1 mA	±1.0°C																																																																
JPt100	-200 to 500 (F.S.=700°C)	1 mA	±0.8°C																																																																
Pt1000	-200 to 500 (F.S.=700°C)	0.2 mA	±0.8°C																																																																
Reference junction compensation	Internal/External switching																																																																		
A/D converter	System : system Resolution : 16-bit (Effective ability: approximate ± range 1/40,000)																																																																		
Temperature coefficient	Gain: 0.01% of F.S./°C Zero: 0.02% of F.S./°C * Zero is generated when using the sampling 10, 20, or 50 ms.																																																																		
Input resistance	1 MΩ±5%																																																																		
Input signal source resistance	300 Ω or less																																																																		
Maximum input voltage	Input terminal +/- interval: 60 Vp-p Input terminal (-)/Input terminal (-) interval: 60 Vp-p Input terminal (-)/GND terminal interval: 60 Vp-p * For details, see "(2) Voltage/Temperature module" in page 2-31.																																																																		
Withstand voltage	Input terminal (-)/Input terminal (-) interval: 350 Vp-p for 1 minute Input terminal (-)/GND terminal interval: 350 Vp-p for 1 minute * For details, see "(2) Voltage/Temperature module" in page 2-31.																																																																		

Item	Description
Insulation resistance	Input terminal (-)/GND terminal interval: 50 M Ω or more (at 500 VDC)
Common mode rejection	90 dB or more (50/60 Hz signal source 300 Ω or less)
S/N (Noise)	48 dB or more (+/- at short)
Filter	OFF, 2, 5, 10, 20, 40 The filter is a moving average. The measured value is the average value of the number of samples set. If the sampling interval is longer than 5 seconds, the average value is obtained from data of the sub-sample.
5 V OUT	Humidity sensor, 1ch for B-530 (optional)
External dimensions (approx.) [W x D x H]	49.2 x 136 x 160 mm (Not including protruding parts)
Weight (approx.)	770 g

High Speed Voltage Amplifier Module (For high speed voltage measurement) (GL7-HSV: optional)

Item	Description
Number of input channels	4 channels/1 module
Input terminal shape	BNC terminal (Non-isolated)
Input method	All-ch insulation, simultaneous sampling, unbalanced input
Sampling interval	1 μ sec fastest
Built-in RAM	2,000,000 data
Measurement range	Voltage: 100, 200, 500 mV, 1, 2, 5, 10, 20, 50, 100, 1-5V F.S.
Measurement accuracy (23 \pm 5 $^{\circ}$ C) • 30 minutes or more after power-up • Filter Line • GND connection	\pm 0.25% of F.S.
A/D converter	System : sequential comparison system Resolution: 16-bit (Effective ability: approximate \pm range 1/40,000)
Temperature coefficient	Gain: 0.01% of F.S./ $^{\circ}$ C Zero: 0.02% of F.S./ $^{\circ}$ C
Input resistance	1 M Ω \pm 5%
Input signal source resistance	1k Ω or less
Maximum input voltage	Input terminal +/- interval: 100 mv to 1 V range \rightarrow 60 Vp-p : 2 V to 100 V range \rightarrow 100 Vp-p Input terminal (-)/Input terminal (-) interval: 60 Vp-p Input terminal (-)/GND terminal interval : 60 Vp-p * For details, see "(3) High Speed Voltage module" in page 2-33.
Withstand voltage	Input terminal (-)/Input terminal (-) interval: 1000 Vp-p for 1 minute Input terminal (-)/GND terminal interval : 1000 Vp-p for 1 minute * For details, see "(3) High Speed Voltage module" in page 2-33.
Insulation resistance	Input terminal/GND terminal interval: 50 M Ω or more (at 500 VDC)
Common mode rejection	90 dB or more (50/60 Hz signal source 300 Ω or less)
S/N (Noise)	48 dB or more (+/- at short)
Frequency response	DC to 200 kHz (+1, -3dB)
Filter	L.P.F. : OFF, Line (1.5 Hz) , 5 Hz, 50 Hz, 500 Hz, 5 kHz, 50 kHz Attenuation: -3 dB (-5.2 dB to -1.4 dB)/6 dB oct
External dimensions (approx.) [W x D x H]	49.2 x 136 x 160 mm (Not including protruding parts)
Weight (approx.)	740 g

Logic/Pulse Amplifier Module (Logic/Pulse) (GL7-L/P: optional)

Item	Description
Number of input channels	16 channels/1 module
Input terminal shape	Dedicated connector (1 group per 4-ch)
Input method	Non-isolated, All-ch insulation, simultaneous sampling, unbalanced input
Sampling interval	Logic: 1 μ sec fastest Pulse: 100 μ sec fastest
Built-in RAM	2,000,000 data
Functions	Logic/Pulse * Switching logic/pulse for each unit The maximum use of the Logic function is 7 modules (112ch). The maximum use of the Pulse function is 2 modules (32ch). The maximum number of connections for each type of amplifier module to the GL7000 is up to 10 modules (112ch maximum).
Mode	Pulse : Rotation/Accumulating/Instant
Revolve mode	Function : This mode counts the pulses for every sampling interval, and then converts them to the RPM. Span : 50, 500, 5000, 50 k, 500 k, 5 M, 50 M, 500 M .RPM/F.S.
Counts mode	Function : Mode for displaying the number of pulses accumulated for every sample interval from the beginning of the recording. Span : 50, 500, 5000, 50 k, 500 k, 5 M, 50 M, 500 M C/F.S.
Instant mode	Function: Mode for displaying the pulse count for every sampling interval. The pulse count is reset for every sampling interval. Span : 50, 500, 5000, 50 k, 500 k, 5 M, 50 M, 500 M C/F.S.
Maximum input frequency	1 MHz
Maximum number of counts	15 MC (24-bit counter)
Input specifications	Max. input voltage : 0 to +24 V (single-ended ground input) Input signal : Non-voltage contact (a contact, b contact, NO, NC), Open collector, Voltage input Input threshold voltage : approx. +2.5 V Hysteresis : approx. 0.5 V (approx. +2.5 V to +3 V)
Filter	OFF, ON (50 Hz, approx. -3 dB)
External dimensions (approx.) [W \times D \times H]	49.2 \times 136 \times 160 mm (Not including protruding parts)
Weight (approx.)	700 g





High-voltage Module (For high-voltage measurements) (GL7-HV: optional)

Item	Description
Number of input channels	2ch/1 module
Input terminal shape	Insulated BNC cable
Input method	All-ch insulation, simultaneous sampling, unbalanced input
Sampling interval	1 μ sec fastest
Built-in RAM	2,000,000 data
Input coupling	DC, AC, DC-RMS, AC-RMS
Measurement range	DC/AC: 2, 5, 10, 20, 50, 100, 200, 500, 1000 V F.S. DC-RMS, AC-RMS: 1, 2, 5, 10, 20, 50, 100, 200, 500Vrms F.S. Crest Factor: (Range between 1 and 200Vrms) 4 or less (Range of 500 Vrms) 2 or less
Measurement accuracy (23 \pm 5 $^{\circ}$ C) • 30 minutes or more after power-up • Filter Line (DC) • GND connection	DC/AC: \pm 0.25% of F.S. DC-RMS: Sine wave \pm 0.5% of F.S. (20 Hz \leq F \leq 1 kHz) \pm 1.5% of F.S. (1 kHz $<$ F \leq 20 kHz) AC-RMS: Sine wave \pm 0.5% of F.S. (100 Hz \leq F \leq 1 kHz) \pm 1.5% of F.S. (1 kHz $<$ F \leq 20 kHz) Response time: 500ms or less (Crest Factor 4 or less) * For information about the crest factor, refer to the next page. * The above RMS measurement accuracy is the accuracy with respect to the voltage of 5 to 100% of each measurement range
A/D converter	System: sequential comparison system Resolution: 16-bit Effective Resolution (DC, AC): Approx. \pm Range 1/40,000 (DC-RMS, AC-RMS): Approx. Range 1/20,000
Temperature coefficient	Gain: 0.01% of F.S./ $^{\circ}$ C Zero: 0.02% of F.S./ $^{\circ}$ C
Input resistance	1 M Ω \pm 5%
Input signal source Resistance	1 k Ω or less
Maximum input voltage	Input terminal (+)/Input terminal (-) interval: 1000 Vp-p Input terminal (-)/Input terminal (-) interval: 300 VACrms Input terminal (-)/GND terminal interval: 300 VACrms * For details, see "(5) High Voltage module" in page 2-36.
Withstand voltage	Input terminal (-)/Input terminal (-) interval: 2300 VACrmsfor 1 minute Input terminal (-)/GND terminal interval: 2300 VACrmsfor 1 minute * For details, see "(5) High Voltage module" in page 2-36.
Insulation resistance	Input terminal (-)/GND terminal interval: 50 M Ω or more (at 500 VDC)
Common mode rejection	90 dB or more (50/60 Hz signal source 300 Ω or less)
S/N (Noise)	48 dB or more (+/- at short)
Frequency response	DC Coupling: DC to 200 kHz (+1/-3 dB) AC Coupling: 4 Hz to 200 kHz (+1/-4.5 dB)
Filter	L.P.F.: OFF, Line (1.5Hz), 5Hz, 50Hz, 500Hz, 5kHz, 50kHz Attenuation: -3 dB (-5.2 dB to -1.4 dB)/6 dB oct
External dimensions (approx.) [W x D x H]	49.2 x 136 x 160 mm (Not including protruding parts)
Weight (approx.)	740 g

Overview of crest factor

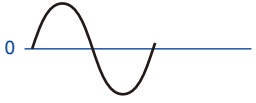
Crest factor is represented by the ratio of the peak value to the effective value of each range. This parameter is necessary to measure the effective value.

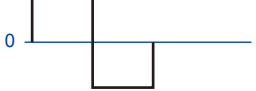
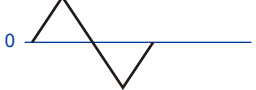
$$\text{Crest factor} = \frac{\text{Peak value}}{\text{Effective value}}$$

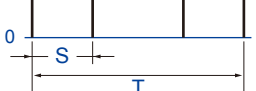
Waveform		Effective value of input waveform	True effective value (displayed value)	Crest Factor
Sine wave Sine curve		1	1	1.414
Full-wave rectification Sine wave Sine curve		1	0.435	1.414
Half-wave rectification Sine wave Sine curve		1	0.771	2
Square wave		1	1	1
Triangular wave		1	0.707	1.732
Pulse wave (duty = 50%)		1	0.707	1.414
Pulse wave		1	$\sqrt{1 - \frac{S}{T}}$	$\sqrt{\frac{T}{S}}$

DC Strain Module (For Strain/voltage/resistance measurement)(GL7-DCB: optional)

Item	Description
Input ch number	4 ch/1 module
Input terminal shape	DSUB 9-pin (female)
Input method	All ch insulation, simultaneous sampling, balanced input
Sampling interval	10 μ s to 1 hour
Built-in RAM	2,000,000 data
Input type	Strain, voltage, resistance values (including potentiometer)
Measurement range	Strain gauge/Strain sensor: 400, 500, 800, 1000, 2000, 4000, 5000, 8000, 10000, 20000 μ (μ : 10^{-6} Strain) 0.2, 0.25, 0.4, 0.5, 1, 2, 2.5, 4, 5, 10 mV/V * The range depends on the bridge voltage. Voltage: 1, 2, 5, 10, 20, 50, 100, 200, 500 mV, 1, 2, 5 V Resistance: 1, 2, 5, 10, 20, 50, 100, 200, 500 Ω , 1, 2, 5, 10, 20, 50 k Ω
Measurement accuracy (23 \pm 5 $^{\circ}$ C) • 30 minutes or more after power-up • Filter Line (DC) • GND connection	Strain: \pm (0.2% of F.S. +10 μ) Voltage: \pm (0.2% of F.S. +10 μ V) Resistance: \pm 0.5% of F.S.(1 hour or more after turning on the power)
A/D converter	System: sequential comparison system Resolution: 16-bit (Effective Resolution: Approx. \pm Range 1/40,000)
Gauge factor	2.0 constant
Sensor supported	Strain: [Strain gauge transducer] 4-wire full bridge, 6-wire full bridge (Available for remote sensing) [Strain gauge] 4-wire full bridge, 6-wire full bridge (3/4-wire: available for remote sensing) 3 or 4 or 5-wire 1/2bridge (4/5-wire: available for remote sensing) 4 or 6-wire full bridge (6-wire: available for remote sensing) Resistance: Potentiometer, resistance
Internal gauge resistance	50 to 10 k Ω (Bridge voltage 1 V: 50 Ω to 10 k Ω , 2 V: 100 Ω to 10 k Ω , 2.5 V: 120 Ω to 10 k Ω , 5 V/10V: 350 Ω to 10 k Ω)
Internal gauge resistor	1/4bridge or 1/2bridge: (available for 120 Ω and 350 Ω gauges) * When the internal gauge resistance is 120 Ω , the bridge voltage 1, 2, 2.5 V are available.
Bridge voltage	DC 1, 2, 2.5, 5, 10 V * When the bridge voltage is 5 V or more, 350 Ω or more gauge is available.
Constant current bridge power supply	0.1 to 20 mA (Voltage supported: Max.10V)
Balancing	Method: Auto-balancing (Range: \pm 10,000 μ) *Strain input only
Remote Sensing	3 or 4-wire 1/4bridge, 4 or 5-wire 1/2 bridge, and 6-wire full bridge are available.
Shunt calibration	Internal approximate 60 k Ω (120 Ω gauge), approximate 175 k Ω (350 Ω gauge)
Temperature coefficient	Gain: \pm 0.02% of F.S./ 0 point: \pm 1.2 μ /
Input resistance	10 M Ω \pm 5%
Maximum input voltage	Differential input: DC10 V Common-mode voltage: 10 VACrms Input terminal (-)/Input terminal (-) interval : 10 Vp-p Input terminal (-)/GND terminal interval : 60Vp-p * For details, see "(6) DC Strain Module" in page 2-37.
Withstand voltage	Input terminal (-)/GND terminal interval : 1000Vp-p 1 minute * For details, see "(6) DC Strain Module" in page 2-37.
Insulation resistance	Input terminal (-)/GND terminal interval: 100 M Ω or more (at DC500 V)
Common mode rejection ratio	80 dB or more (50/60 Hz signal source 300 Ω or less)
Noise	50 μ or less (DC2V, 350 Ω)
Frequency response	DC to 20 kHz
Filter	L.P.F.: OFF, Line (1.5 Hz) 3, 6, 10, 30, 50, 60,100, 300, 500 Hz, 1, 3, 5, 10kHz at -30 dB/oct A.A.F.: OFF/ON (Anti-aliasing filter)
TEDS	Standards: Conforms to IEEE1451.4 Class2 (Template No. 33) Information: Readout and auto-set for sensor data
Accessorie	DSUB (male) connector : 4

Item	Description
External dimensions (approx.) [W × D × H]	49.2 × 136 × 160 mm (not including protruding parts)
Weight (approximate)	840 g

Charge Module (For Acceleration measurement)(GL7-CHA: optional)

Item	Description
Input ch number	4 ch/1 module
Input terminal shape	BNC terminal (non-isolated) Miniature connector (#10-32UNF) * Only one terminal is available for each channel.
Input method	Insulation, simultaneous sampling, unbalanced input
Sampling interval	10 μ s to 1 hour
Built-in RAM	2,000,000 data
Input coupling	Off, Charge, IEPE, Microphone, DC, AC, Charge-RMS, IEPE-RMS, DC -RMS, AC-RMS
Measurement range	Acceleration sensor: 1, 2, 10, 20, 50, 100, 200, 500 m/s^2 1000, 2000, 5000, 10000, 20000, 50000 m/s^2 Voltage input: AC, DC : 50, 100, 200, 500 mV, 1, 2, 5, 10 V RMS: 20, 50, 100, 200, 500 mVrms, 1, 2, 5 Vrms Crest Factor: (2 Vrms range or less) 4 or less, (5 Vrms range) 2 or less Microphone: 200, 400, 500 mPa; 1, 2, 4, 5, 10, 20, 40, 50, 100, 200, 400, 500 Pa
Sensor sensitivity	Charge input: 0.01 pC/(m/s^2) to 999.9 pC/(m/s^2) Voltage input: 0.01 mV/(m/s^2) to 999.9 mV/(m/s^2) Microphone: 0.2 mV/Pa to 100 mV/Pa
Measurement accuracy (23 \pm 5°C) • 30 minutes or more after power-up • Filter Line (DC) • GND connection	Charge input : \pm 0.9% of F.S. [Sensor sensitivity] x [Setting range] \geq 20 pC Voltage input : \pm 0.25% of F.S. [Sensor sensitivity] x [Setting range] \geq 200 mV Microphone : [Sensor sensitivity] x [Setting range] \geq 200 mV Voltage : \pm 0.25% of F.S. DC-RMS : Sine wave \pm 0.5% of FS (20 Hz \leq F \leq 1 kHz) \pm 1.5% of FS (1 kHz<F \leq 5 kHz) AC-RMS : Sine wave \pm 0.5% of FS (100 Hz \leq F \leq 1 kHz) \pm 1.5% of FS (1 kHz<F \leq 5 kHz) Charge-RMS: Sine wave \pm 1.4% of F.S. (20 Hz \leq F \leq 1 kHz) IEPE-RMS : Sine wave \pm 0.75% of FS (20 Hz \leq F \leq 1 kHz) * The above RMS measurement accuracy is the accuracy with respect to the voltage of 5 to 100% of each measurement range.
A/D converter	System: sequential comparison system Resolution: 16-bit (Effective Resolution: Approx. \pm Range 1/40,000)
Temperature coefficient	Gain: \pm 0.01% of F.S./ Zero: \pm 0.02% of F.S./
Input resistance	100 k Ω \pm 5%
Power supply	22 V \pm 10%, 4 mA, 8 mA \pm 20%
Max. input charge	50,000 pC
Maximum input voltage	Input terminal(+)/ Input terminal (-) interval: 25 Vp-p Input terminal(-)/Input terminal (-) interval: 25 Vp-p Input terminal (-)/GND terminal interval: 25 Vp-p * For details, see "(7) Charge Module" in page 2-42.
Withstand voltage	Input terminal(+)/Input terminal (-) interval : 300 Vp-p 1 minute Input terminal (-)/GND terminal interval: 300 Vp-p 1 minute * For details, see "(7) Charge Module" in page 2-42.
Insulation resistance	Input terminal (-)/GND terminal interval: 50 M Ω or more (at DC500 V)
Common mode rejection ratio	80 dB or more (50/60 Hz signal source 300 Ω or less)
S/N (Noise)	48 db or more (+/- at short)
Frequency response	Charge-type: 1.5 Hz to 45 kHz Voltage-type: 1 Hz to 45 kHz
Filter	H.P.F.: OFF, 0.15, 1, 10 Hz L.P.F.: OFF, Line (1.5 Hz) 3, 6, 10, 30, 50, 60 Hz, 100, 300, 500 Hz, 1, 3, 5, 10 kHz at -30 dB/oct A.A.F.: OFF, ON (Anti-aliasing filter)

Item	Description
TEDS	Standards: Conforms to IEEE1451.4 Class1 (Template No. 25, No. 27) Information: Readout and auto-set for sensor data
External dimensions (approx.) [W × D × H]	49.2 × 136 × 160 mm (not including protruding parts)
Weight (approximate)	850g

Voltage Output Module (For output voltage measurement) (GL7-DCO: optional)

Item	Description
Output ch number	8 ch/1 module
Output terminal shape	SMA connector
Output method	All channels common ground
Sampling interval	10 fastest
Output objects	Off, Data file (Recorded data in the module to be output, Simple arbitrary waveform Note 1) DC, Sine wave, Traiangle wave, Ramp wave, Pulse wave <Equipment to be output> Recorded data module that can output the voltage <ul style="list-style-type: none"> ● Voltage module (GL7-V) ● Voltage/Temperature module (GL7-M) ● High speed voltage module (GL7-HSV) ● High voltage module (GL7-HV) ● DC Strain module (GL7-DCB) ● Charge module (GL7-CHA) < Output Conditions > <ul style="list-style-type: none"> ● The sample interval is 10 s or more ● While the waveform is output from the output module, the data measured in the other amplifier module can be recorded.Data type ● Not possible to output the data of Temperature / Humidity and Logic / Pulse Note 1: Using the GL-Wave Editor supplied with the GL-Connection, the CSV waveform data can be generated arbitrarily. * Microsoft EXCEL (Office 2003 or later) must be installed."
Output range	±1, 2, 5, 10 V/F.S.
Output accuracy (23 ±5)	±0.25% of F.S. * At least 30 minutes after turning on the power.
D/A converter	Resolution: 16-bit (Effective ability: Approximate ± range 1/20,000)
Temperature coefficient	Gain: ±0.01% of F.S./ Zero: ±0.02% of F.S./ "
Allowable load resistance	1kΩ or more
Maximum output current	Maximum output current ±10 mA/ch However, total ±40 mA or less of the output current per 1 module should be used.
Output impedance	1Ω or less
S/N (Noise)	48 dB or more (at OV output)
Filter	L. P. F : OFF, Line (1.5 Hz), 5 Hz, 50 Hz, 500 Hz, 5 kHz, 50 kHz *This filter is a smoothing filter to remove noise of the D/A converter.
External dimensions (approx.) [W × D × H]	49.2 × 136 × 160 mm (not including protruding parts)
Weight (approximate)	770g

4.5 Accessory/Option Specifications

Control software (GL-Connection)

Item	Description
OS supported	Windows 10 (32-Bit/64-Bit) * GL-Connection Ver. 1.64 or later Windows 8 / 8.1 (32-Bit/64-Bit) * Operating systems that the OS manufacturer no longer supports are also not supported by Graphtec.
Functions	Controlling main module, real-time recording data, conversion, data replay
Number of main module connected	Max. 10 modules* ¹ GL-Connection version 2.00 or later Max. 20 modules* ¹ les
Number of channels per one main module	Max. 112 channels* ¹
Max. number of channels	1120 channels* ¹ GL-Connection version 2.00 or later Max. 2240 channels* ¹
Setting range	Amplifier settings, recording settings, trigger/alarm settings, report settings, others
Captured data	Built-in RAM (binary) SSD (CSV, binary) Built-in flash memory (CSV, binary) SD card (CSV, binary) * For CSV data, the corresponding high speed sampling interval will be up to 1 msec. (For 1CH) * The recorded data cannot save the built-in RAM or SSD in real time. After recorded, the data is saved in PC while replaying on the GL7000.
Display	Analog waveforms, logic waveforms, pulse waveforms, digital values
Display modes	Y-T View (displayed in the digital value), X-Y View (in real time), FFT View, Cursor Information View, Recorded Data View, Alarm Information View * Digital display can be attained by maximizing the digital part of the Y-T.
File conversion	Between cursors, All data, Thinning function
Mailing functionality	A mail is sent to a specified address when an alarm occurs
Statistics display	During recording: maximum value, minimum value, Average value, peak value During replaying: maximum value, minimum value, Average value, peak value, RMS
Search function	Level search : Searches at any channel or any level. Alarm search: Searches at any channel or any alarm. Time move : Move to first, Move to last, Move to center, Move to trigger, Move to absolute time, Move to Relative time, Move to data points, Move to mark.
Screen lock function	Locks the operation (with arbitrary password setting function)
Data output function	PC file data (GBD/CSV), Module file data (GBD), DC, Sinusoidal wave, Triangular wave, Ramp wave, Pulse wave * GL-Connection version 1.40 or later * When the Voltage Output Module is installed, this function is available

*1: There are limitations to real-time transfer. The more the number of channels increases, the more limited the real-time display of the sampling interval becomes.

The number of DC strain modules that can be installed is up to 8 modules.

Standard accessories

Item	Description	Quantity
Alarm Output Module	This is installed in the main module at shipping.	1
Quick Start Guide	GL7000-UM-85X	1
CD-ROM	User's Manual (PDF), Application software	1
Face cover	This is installed in the main module at shipping.	1
AC cable		1

Humidity sensor: B-530 (optional)

Item	Description																		
Allowable temperature range	-25 to +80°C																		
Allowable temperature range	0 to 100% R.H.																		
System	Electric capacity type																		
Relative humidity measurement accuracy (5 to 98% R.H.)	<table border="1"> <thead> <tr> <th>Measurement environment</th> <th>Measurement accuracy</th> </tr> </thead> <tbody> <tr> <td>0 to 10°C</td> <td>±5%R.H.</td> </tr> <tr> <td>10 to 20°C</td> <td>±4%R.H.</td> </tr> <tr> <td>20 to 30°C</td> <td>±3%R.H.</td> </tr> <tr> <td>30 to 40°C</td> <td>±4%R.H.</td> </tr> <tr> <td>40 to 50°C</td> <td>±5%R.H.</td> </tr> <tr> <td>50 to 60°C</td> <td>±6%R.H.</td> </tr> <tr> <td>60 to 70°C</td> <td>±7%R.H.</td> </tr> <tr> <td>70 to 80°C</td> <td>±8%R.H.</td> </tr> </tbody> </table>	Measurement environment	Measurement accuracy	0 to 10°C	±5%R.H.	10 to 20°C	±4%R.H.	20 to 30°C	±3%R.H.	30 to 40°C	±4%R.H.	40 to 50°C	±5%R.H.	50 to 60°C	±6%R.H.	60 to 70°C	±7%R.H.	70 to 80°C	±8%R.H.
	Measurement environment	Measurement accuracy																	
	0 to 10°C	±5%R.H.																	
	10 to 20°C	±4%R.H.																	
	20 to 30°C	±3%R.H.																	
	30 to 40°C	±4%R.H.																	
	40 to 50°C	±5%R.H.																	
	50 to 60°C	±6%R.H.																	
	60 to 70°C	±7%R.H.																	
70 to 80°C	±8%R.H.																		
* 60°C or more measurement accuracy is a reference value.																			
Response time	15 sec. (90% response when membrane filter installed)																		
Sensor output	0 to 1 V DC																		
Outside diameter	14 mm×80 mm (excluding cable)																		
Cable Length	3 m																		
Sensor power	+5 to 16 VDC																		
Consumption current	Approx. 4 mA																		

4.6 Accessories

Optional Accessories

Item	Model	Description
Sync cable for GL7000	B-559	Sync cable between devices
Probe for logic/pulse	RIC-10A	4ch input (Set of alligator clip and IC clip)
BNC-BNC cable	RIC-112	1.5 m, 60VDC or less
BNC-Banana cable	RIC-113	1.5 m, 60VDC or less
BNC-Alligator cable	RIC-114	1.5 m, 60VDC or less
Safe probe	RIC-141A	1:1 42pF, Length 1.2 m, 300VDC, CAT II
Insulated BNC-BNC cable	RIC-142	Length 1.5 m, 1000 VDC, CAT II
Insulated BNC-Banana cable	RIC-143	Length 1.6 m, 600 VDC, CAT II
Alligator clip (small) *2	RIC-144A	Aperture: 11 mm, 300 VDC, CAT II, MAX15A
Alligator clip (Middle) *2	RIC-145	20 mm, 1000 VDC, CAT III, MAX32A
Grabber Clips*2	RIC-146	Aperture: 5 mm, 1000 VDC, CAT III, MAX1A
Input/output cable for GL	B-513	2 m, Bare tips
Humidity sensor*1	B-530	3 m, With a dedicated power connector
Humidity sensor power box	B-542	Humidity sensor, 10-wiring, Built to order
M3 screws with flat washers	B-543	60 pcs.
Shunt resistance 250Ω	B-551	250Ω, Rated power of 1W, Maximum service voltage of 15.8 V, Built to order
DSUB-NDIS conversion cable	B-561	DSUB-NDIS conversion cable for DC Strain Module only
SMA-BNC conversion cable	B-562	SMA-BNC conversion cable (2 m) for Voltage Output Module
B-560A	DSUB-Screw terminal conversion connector	DSUB connection conversion connector for strain unit (with B-560AP)
B-560AP	Substrate holding parts for B-560A	Parts available even when the connector cover is not attached to the DSUB-screw terminal conversion connector.
B-560-05	Extension cable (50 cm) for B-560A	DSUB (male)-DSUB (female) available for DSUB-screw terminal conversion connector, cable length 50 cm
B-585	Carrying tool for GL7000	Tools that can carry the GL 7000 with three amplifier units/ two amplifier units and one SSD unit
B-586	Trunk for GL7000	A trunk that can carry and store up to one GL7000 or three amplifier units/two amplifier units and one SSD unit. (When using a caster, please use it on a smooth surface only.)
Extra fine K-type thermocouple (TC200/TD1000), 5 per set	ST-55K-TC-1.2M	Tip wire ϕ 0.127, 0.5 x 0.7 x 200 mm, Relay section 1 m, 5 per set
Needle-shape K-type thermocouple	RIC-410	-100 to 300°C, Class 1, Cord length: 1.1 m
Stationery-surface K-type thermocouple	RIC-420	-30 to 400°C, Class 2, Cord length: 1.1 m
L-type stationery-surface K-type thermocouple	RIC-430	-30 to 600°C, Class 2, Cord length: 1.1 m

*1: Allowable temperature range: -25 to +80°C

*2: One each for red and black, Connect to RIC-143

4.7 External view

GL7000 Main Module + Alarm Module

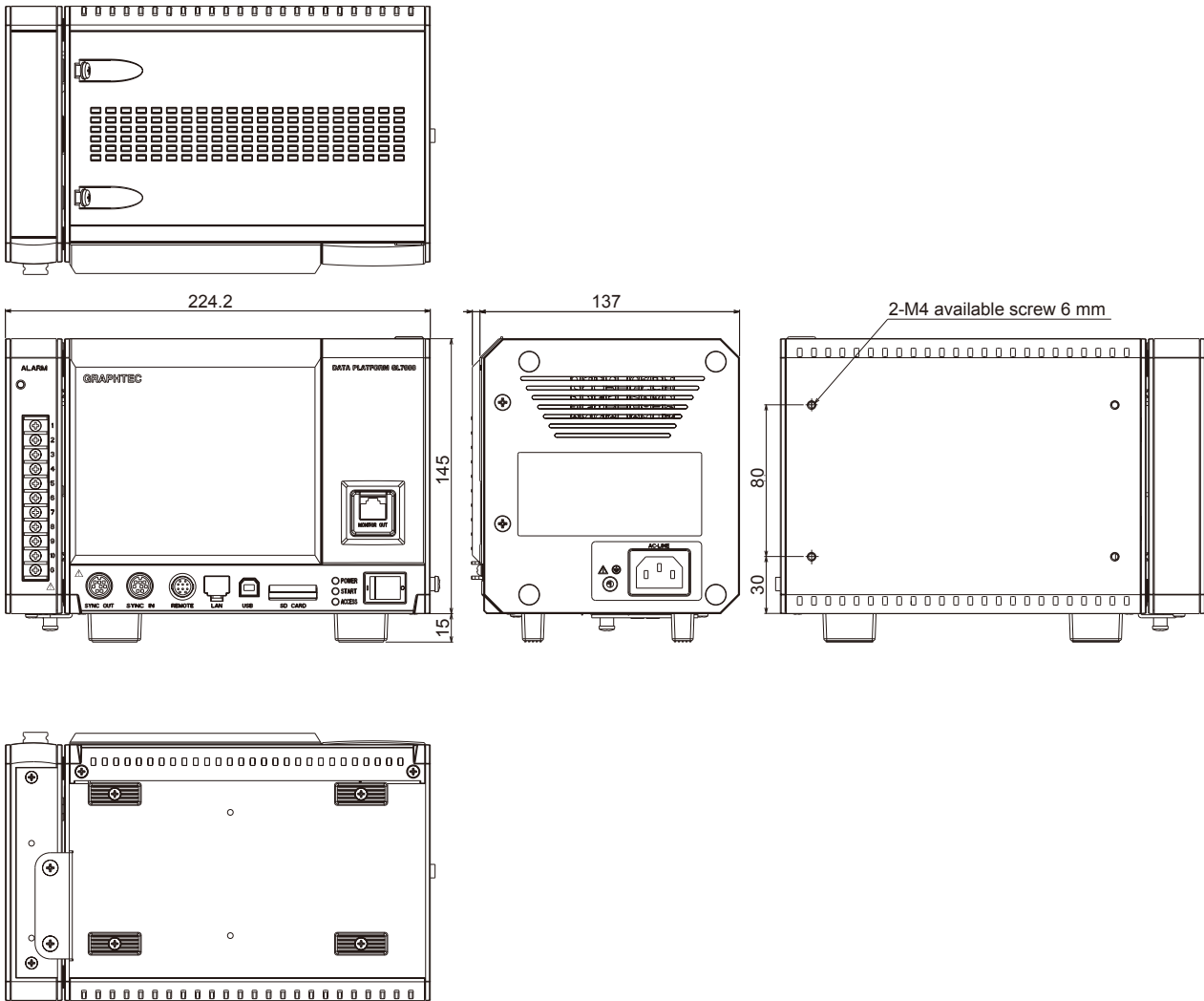

Unit: mm
Dimensional accuracy: ± 5 mm

Display Module (GL7-DISP) : Optional

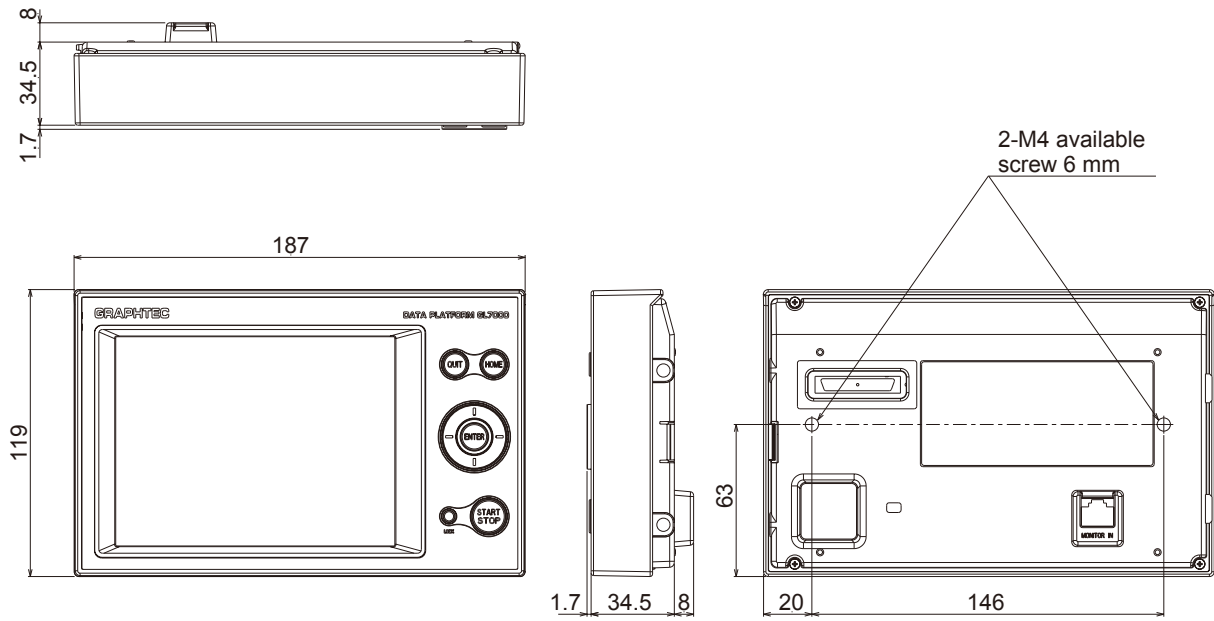

Unit: mm
Dimensional accuracy: ±5 mm

SSD Module: (GL7-SSD) : Optional

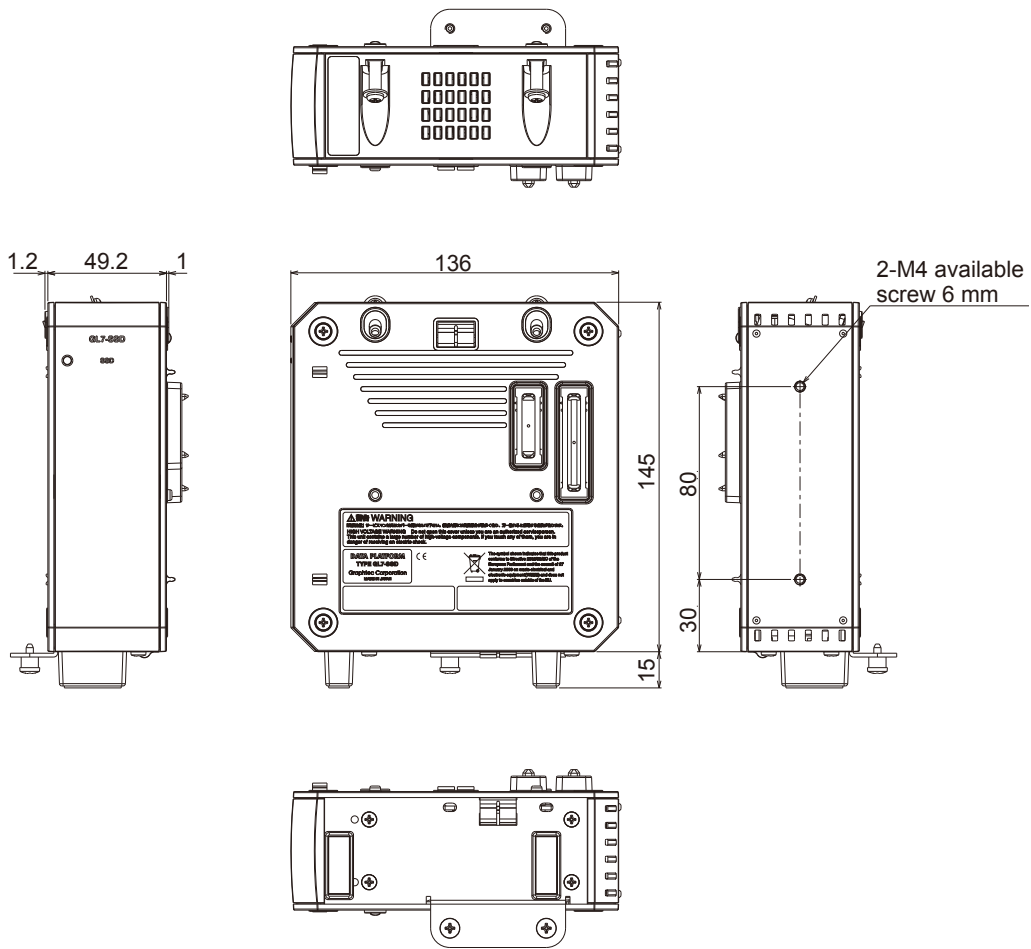

Unit: mm
Dimensional accuracy: ±5 mm

Voltage Module: (GL7-V) : Optional

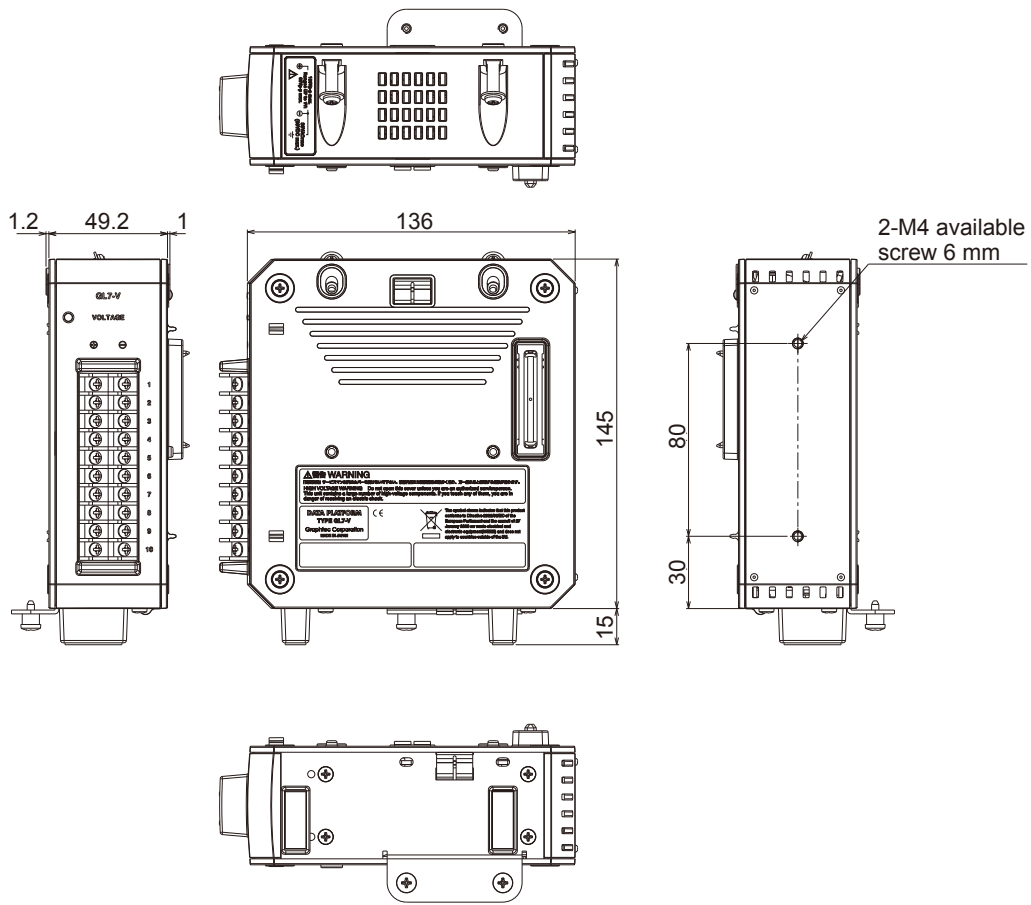

Unit: mm
 Dimensional accuracy: ±5 mm

High Speed Voltage Module: (GL7-HSV) : Optional

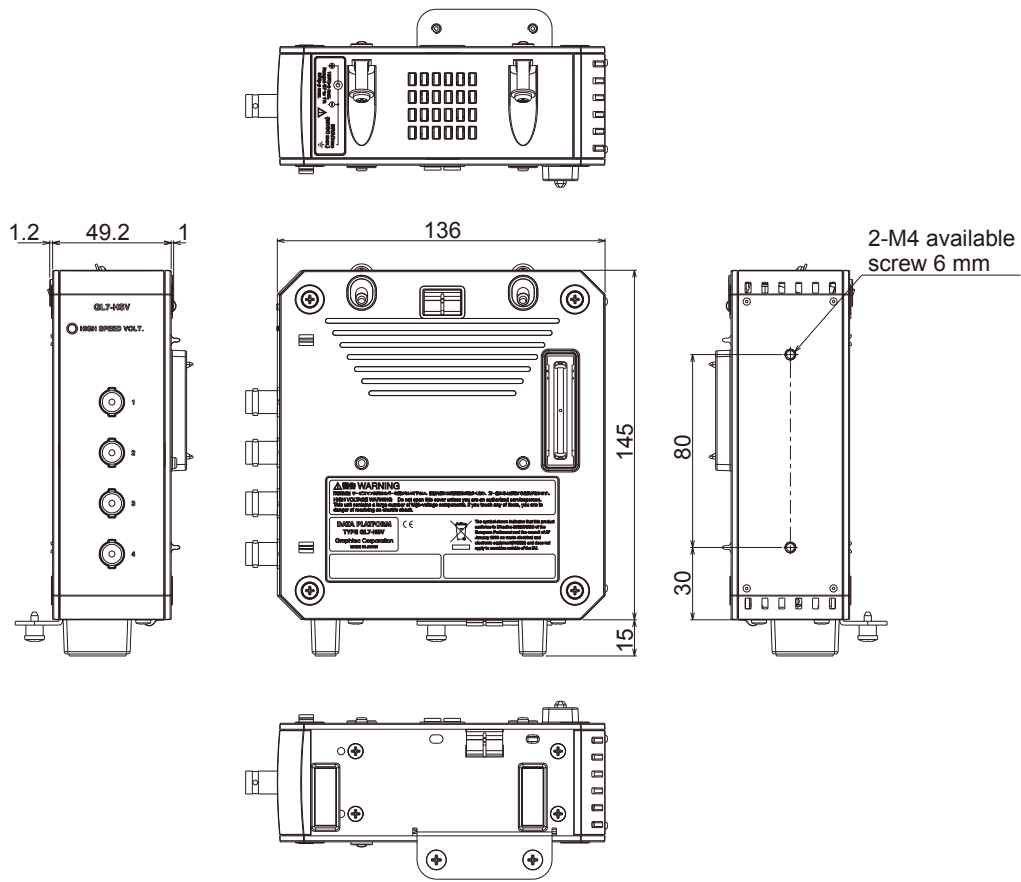

Unit: mm
Dimensional accuracy: ±5 mm

Voltage/Temperature Module: (GL7-M) : Optional

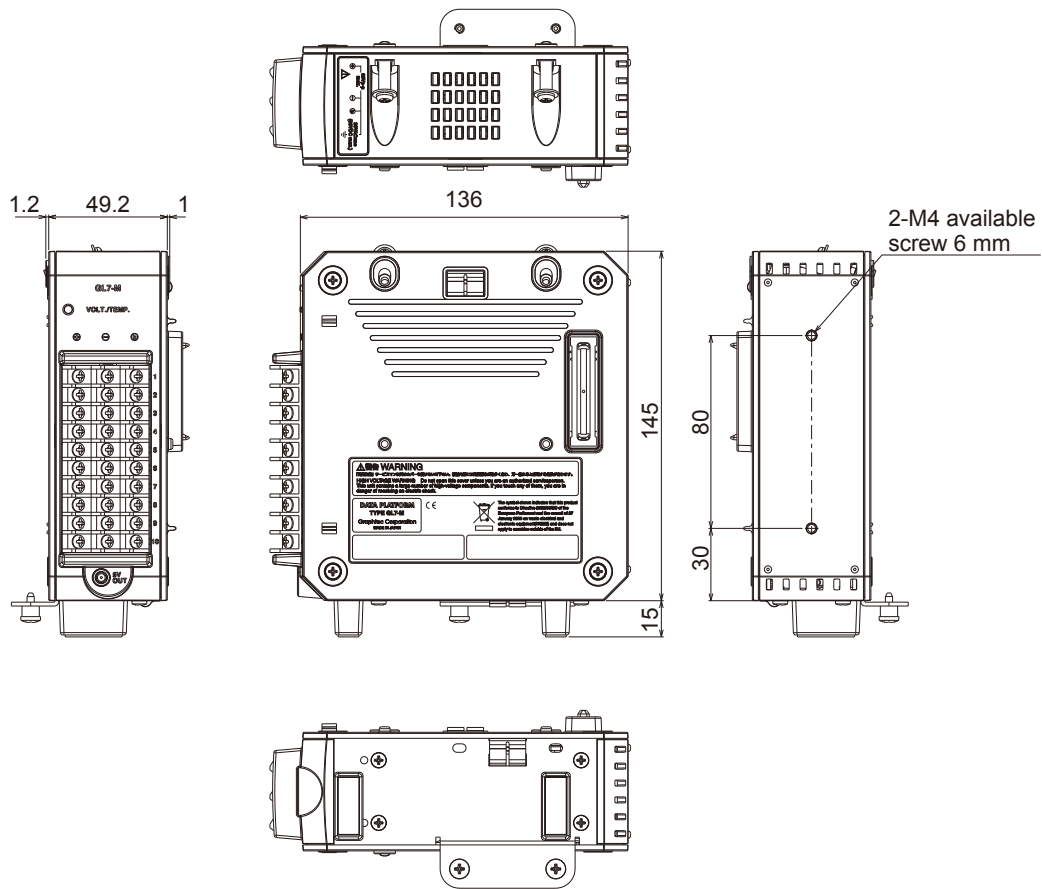

Unit: mm
Dimensional accuracy: ±5 mm

Logic/Pulse Module: (GL7-L/P) : Optional

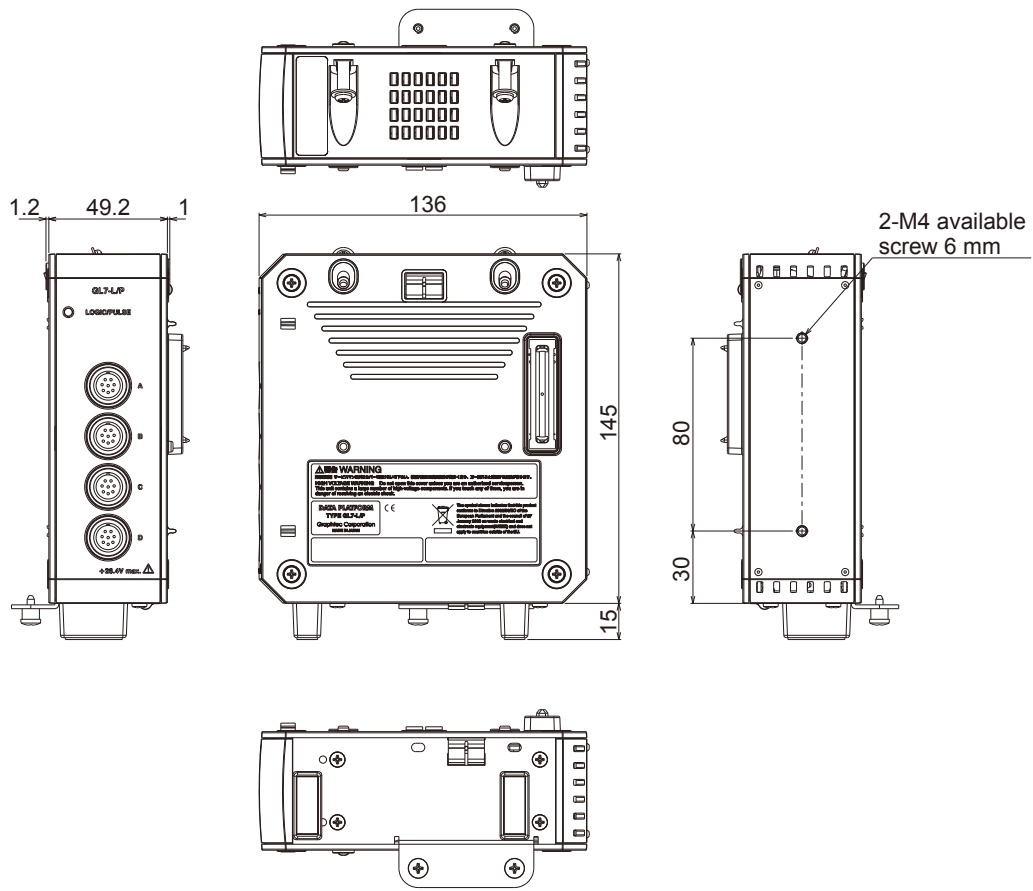

Unit: mm
Dimensional accuracy: ±5 mm

High-voltage Module: (GL7-HV) : Optional

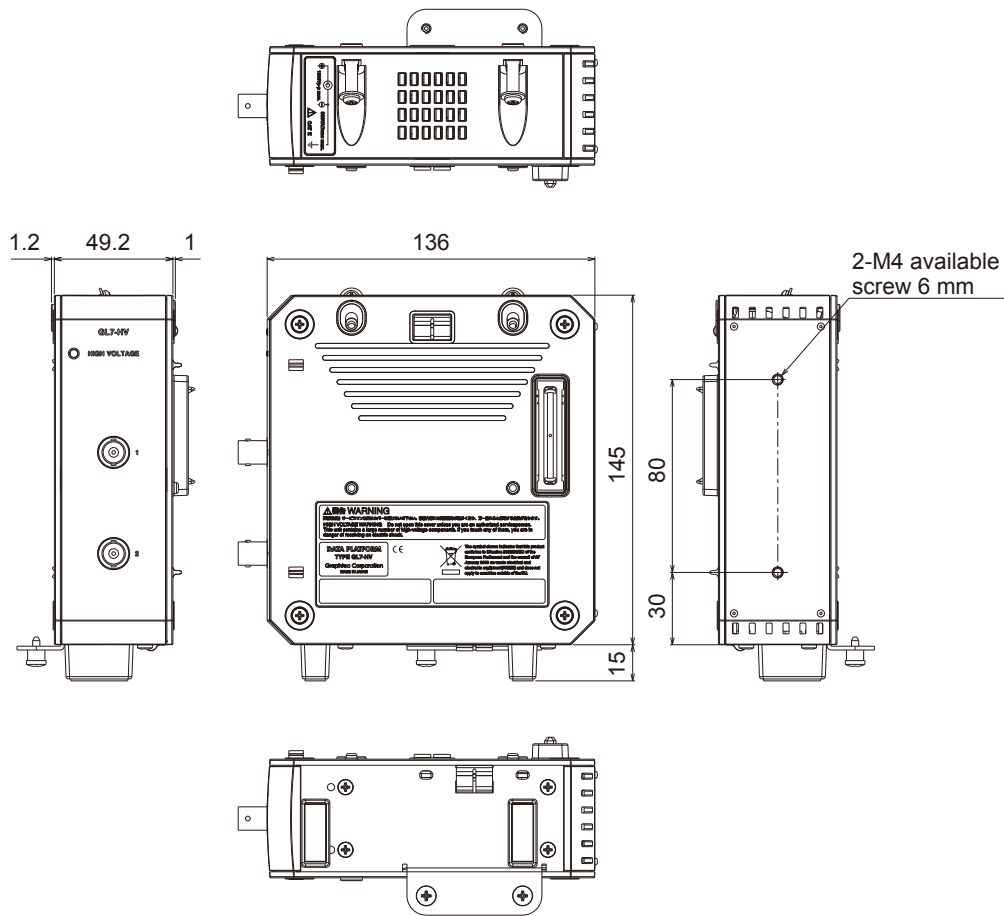

Unit: mm
Dimensional accuracy: ± 5 mm

DC Strain Module (GL7-DCB): Optional

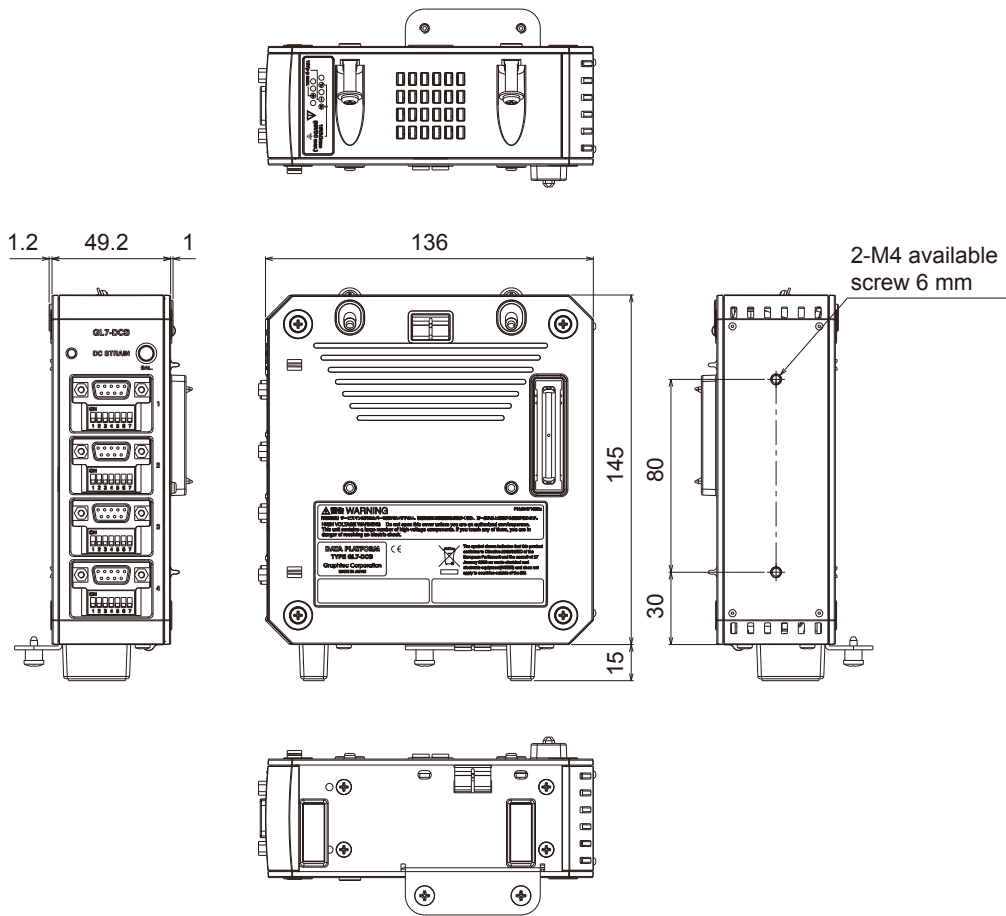

Unit: mm
Dimensional accuracy: ± 5 mm

Charge Module (GL7-CHA): Optional

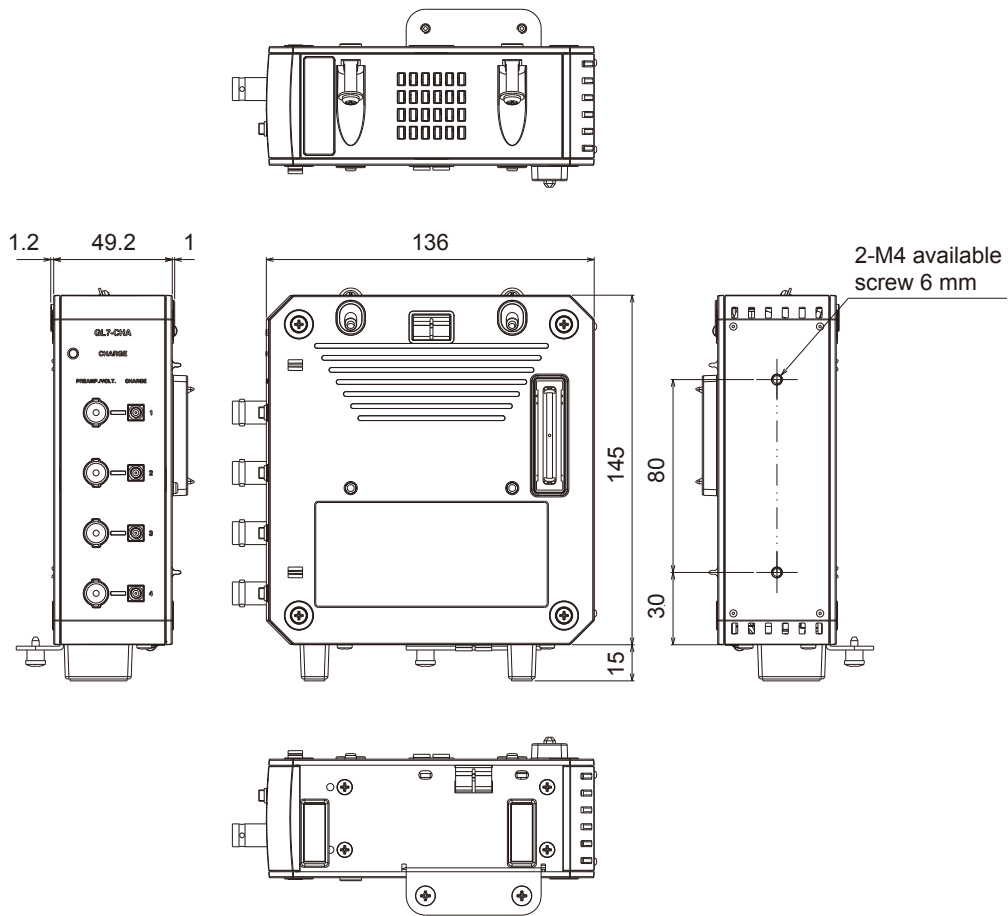

Unit: mm
Dimensional accuracy: ±5 mm

Voltage Output Module (GL7-DCO): Optional

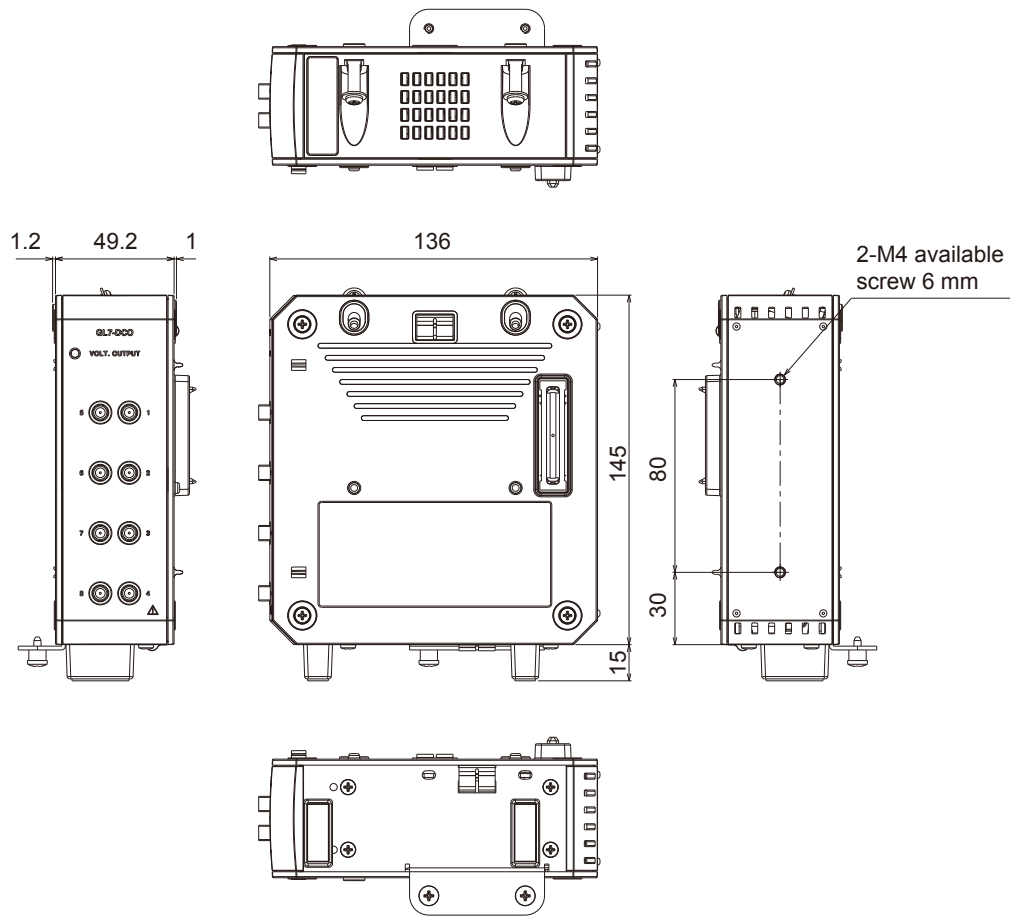

Unit: mm
Dimensional accuracy: ± 5 mm

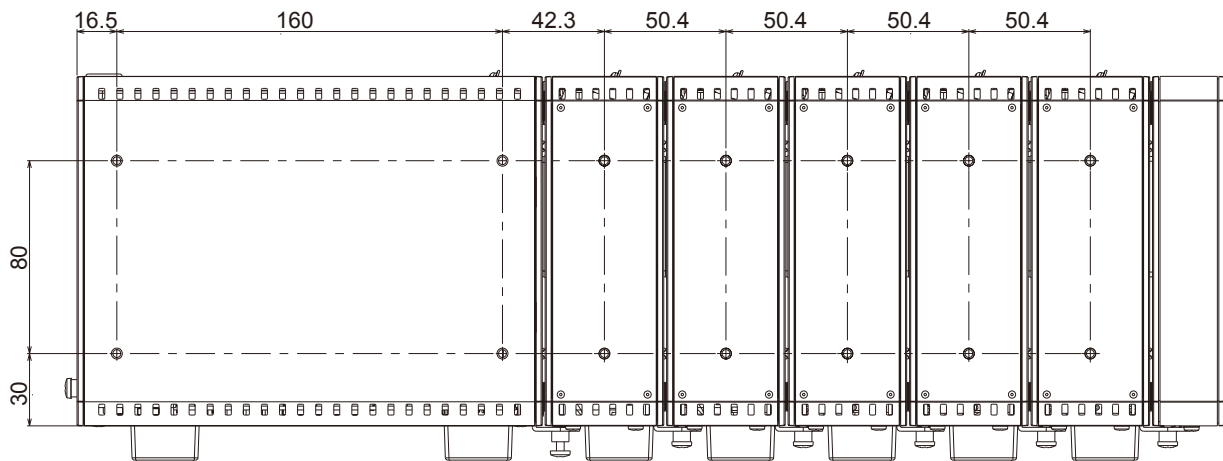
Rear view when an optional module is mounted

Unit: mm
Dimensional accuracy: ± 5 mm

INDEX

Sign

2 screen replaying **3-52**

A

Accessories **2-2, 4-23**
 AC Line cycle **3-95**
 AC Line filter **3-63**
 AC power **2-28**
 Action screen **3-163**
 A-Cursor **3-160**
 Adjust mode **3-93**
 Alarm displays **3-4**
 Alarm hold **3-86**
 Alarm level settings **3-133**
 Alarm port number **3-85**
 Amplifier Module Specifications **4-10**
 Amplifier settings **3-10**
 Amplitude **3-80**
 Annotation **3-125**
 Apply **3-92**
 Auto balance button (GL7-DCB) **3-96**
 Auto save **3-65**

B

Backup destination **3-76**
 Backup intervals **3-76**
 Backup settings **3-76**
 B-Cursor **3-160**
 Bridge circuit **2-41**
 Built-in flash memory access displays **3-3**
 Burnout alarm **3-86**

C

Calc. settings **3-141**
 Calculation between channels **3-126**
 Call other cursor **3-160**
 Capture point **3-64**
 Changing the Display Language **1-7**
 Channel **3-161**
 Channel displays **3-13**
 Channel type **3-161**
 Charge Module **2-15, 2-42, 4-18**
 Clock **3-5**
 Close button **3-10, 3-12, 3-14**
 Combination **3-129, 3-133**
 Common Process Screens **3-28**
 Connecting the Power Cable **2-28**
 Connection test **3-91, 3-93**
 Connect to Analog Signal Input Terminal **2-30**
 Control software **4-21**

Current capturing destination **3-70**
 Current capturing file name **3-70**
 Current sample interval **3-70**
 Current timer setting **3-72**
 Cursor **3-10**
 Cursor position **3-159**
 Cursor sync **3-160**

D

Data load **3-81, 3-82**
 Data points **3-78**
 Data recording functions **4-5**
 Data relaying screen **3-152**
 Data save **3-68, 3-153**
 Data search **3-161**
 Data type **3-79**
 Data with CSV format **3-165**
 Date **3-92**
 Date setting **3-85**
 Date/Time settings **3-92**
 DCO module settings **3-78**
 DC Strain Module **2-14, 2-37, 4-16**
 Delay **3-80**
 Demo waveform **3-96**
 Destination **3-63**
 Detection of the trigger **3-130**
 Digital displays **3-5**
 Direction keys **3-44**
 Display mode **3-139**
 Display module **4-9**
 Display Module **2-6**
 Display settings **3-137**
 DNS address **3-89**
 Duty **3-80**

E

Each Operating Mode **3-48**
 Edge action **3-129**
 Emergency stop alarm CH output **3-82**
 ENTER **3-44**
 Enter a character **3-30**
 EU **3-124**
 Event capturing **3-73**
 Explanation of symbols used on the equipment **1-7**
 External Input/Output functions **4-8**
 External view **4-24**

F

FFT display **3-148**
 FFT Display **3-145**

File name	3-78, 3-152, 3-153, 3-155, 3-158
File operations	3-32, 3-152
File type	3-154, 3-158
Filter	3-80, 3-122
Format	3-142
Free running	3-49
Frequency	3-80
FTP server	3-90
FTP server settings	3-90
Function buttons	3-5
Function Module Specifications	4-9
Function Specifications	4-5

G

Gateway	3-89
GL input and output cabling	2-46
GL input/output cable	2-45
GND terminal	2-29

H

High Speed Voltage Amplifier Module	4-12
High Speed Voltage Module	2-10, 2-33
High voltage Module	2-13
High-voltage Module	2-36, 4-14
HOME	3-43
HOME button	3-5
HOME screen	3-9
Humidity sensor: B-530	4-22
Hysteresis	3-131
Hysteresis level	3-131

I

ID Name	3-89
I/F, USB settings	3-87
Information	3-97
Input	3-114
Input settings	3-98
Installation location	2-26
Installation space	2-26
Installing and removing the Module	2-17
Installing the amplifier module for measurement	2-22
Installing the Display Module	2-17
Install SSD Module	2-25
Inter-CH operation settings	3-126
Internal equivalent circuit in input/output circuit	2-46
Internal memory devices	4-3
Internet time	3-92
IP address	3-89
IP address auto acquire	3-88
IP settings	3-88

K

Keep alive	3-89
Key click	3-96
Key-lock	3-47
Key-lock displays	3-4
Key Operations	3-43

L

Language	3-97
LCD brightness	3-96
Level	3-162
Level action	3-129
Level settings	3-84
Level/Upper limit value/Lower limit value	3-131, 3-134
List of power consumption for each unit	4-3
Load	3-155
LOCAL	3-46
LOCK	3-46
Logic/Pulse Amplifier Module	4-13
Logic/Pulse Module	2-12, 2-34
Logic settings	3-84

M

Machine settings	3-9
Main module Nomenclature and Functions	2-4
Marker	3-75
Marker settings	3-75
Marking	3-75
Menu screen	3-12
Menu tree	3-15
Mode	3-130, 3-134, 3-161
Module Specifications	4-9
Move	3-160
Move date/time	3-160
Move position	3-160
Move to center	3-159
Move to first	3-159
Move to last	3-160
Move to selected position	3-160
Move to trigger	3-160

N

Name type	3-153, 3-155, 3-158
Navigator	3-9, 3-11, 3-12, 3-13
New line Code	3-87
Next CH button	3-14
Next search	3-162
Noise Countermeasures	2-48
Nomenclature	3-2
Notes on Temperature Measurement	1-6
Notes on Using the Monitor	1-6
NTP server	3-93

Number of pulses per revolution **3-115**
 Numerical entry **3-28**

O

Offset **3-80**
 Operate the XY display **3-144**
 Operating Environment **1-4**
 Optional Accessories **4-23**
 Optional Modules **2-2**
 Other settings **3-94, 3-127**
 Output **3-134**
 Output level at the time of Stop **3-82**
 Output range **3-80**
 Output sampling interval **3-78**
 Output settings **3-77**
 Output settings (DCO module settings) **3-166**
 Output source **3-78**

P

Pass word **3-90**
 PASV Mode **3-90**
 PC I/F **4-4**
 Pen display **3-6**
 Phase **3-80**
 Port number **3-89, 3-90**
 Power on start **3-94**
 Pretrigger points **3-86**
 Previous CH button **3-14**
 Prev. search **3-162**
 Pulse span settings **3-140**

Q

QUIT **3-46**

R

Range **3-115**
 Read from the output source **3-79**
 Recording **3-50**
 Recording bar **3-7**
 Record settings **3-58**
 Remote displays **3-4**
 REMOTE Functions **2-47**
 Repeat **3-85**
 Repeat interval **3-86**
 Repeat output **3-82**
 Replay **3-152**
 Replaying **3-54**
 Replay setting screen **3-152**
 Restart network **3-89**
 Ring capture **3-66**

S

Safety Precautions **ii**
 Sample interval **3-5, 3-62**
 Save **3-154, 3-155, 3-158**
 Save folder **3-76**
 Save/Load current settings **3-154**
 Save Range **3-154**
 Saving contents **3-155**
 Scale display **3-7**
 Scaling settings **3-124**
 Screen saver **3-96**
 Screenshot **3-158**
 SD card access displays **3-3**
 Set the channel to be displayed **3-142**
 Settings Menu **3-58**
 Settings screen **3-13**
 Simple message **3-2**
 Simple Waveform Setting **3-135**
 Slope **3-115**
 Slope of the pulse **3-115**
 Source **3-152**
 Span **3-125**
 Span/Position/Trace **3-136**
 Span settings **3-139**
 SSD access displays **3-4**
 SSD Module **2-8, 4-9**
 Standard accessories **4-22**
 Standard Specifications **4-2**
 Start output **3-81, 3-82**
 Start source **3-84**
 Start/Stop **3-129**
 START/STOP **3-44**
 Start / Stop confirmation message **3-95**
 Start/Stop synchronization **3-82**
 Statistical calculation **3-164**
 Status mark **3-4**
 Stop source **3-84**
 Strain gauge **2-41**
 Strain unit **3-96**
 Subnet mask **3-89**
 Swapping out the SD card **3-156**
 Synchronization function **4-8**
 Synchronized interval **3-93**
 System information **3-97**

T

Temperature setting **3-95**
 Tilting table **2-7**
 Time **3-92**

Time/DIV	3-3, 3-136
Time settings	3-85
Time zone	3-93
Title	3-12, 3-13
To Ensure Safe and Correct Use	i
Touch-panel Functions	3-26
Trace settings	3-140
Trigger/Alarm settings	3-83
Trigger and Alarm functions	4-6
Trigger level settings	3-128
Turning on the Power	2-28

U

USB Drive Mode	3-45
USB ID	3-87
User name	3-90

V

Various functions	4-7
Various icons	3-10, 3-12
Various setting buttons	3-14
Voltage Module	2-9, 2-30, 4-10
Voltage Output Module	2-16, 2-44, 4-20
Voltage/Temperature Module	2-11, 2-31, 4-11

W

Waveform + Digital Screen	3-2
Waveform display	3-6
Waveform setting	3-135
Web server functions	3-168
Weekly settings	3-85

X

XY display settings	3-143
-------------------------------	--------------

Z

Zone setting	3-136, 3-140
------------------------	---------------------

Specifications are subject to change without notice.

GL7000 Series User's Manual

GL7000-UM-156

September 17 2021 6th

GRAPHTEC CORPORATION

GRAPHTEC