

midi LOGGER GL240

Quick Start Guide

604249022 GL240-UM-852



GRAPHTEC

Thank you for choosing Graphtec midi LOGGER GL240.
The Quick Start Guide is to assist with the basic operations.
Please refer to the USER'S MANUAL (PDF) in the CD-ROM for more
in-depth information.

Check the exterior of the unit to ensure that there are no cracks, defects, or
any other damages before use.

Accessories

- Quick Start Guide : 1
- Ferrite core: 1
- CD-ROM : 1
- AC cable/AC adapter : 1

Contents

Nomenclature	2
Connection Procedures	3
Safety Guide for using GL240	5
Descriptions of the Control Panel Keys	6
Descriptions of the Menu Screens	9
Measuring Procedure	10
1. Preparations : Hardware set up for recording	10
2. Setup : Menu Operation	11
3. Data record : How to Record	14
4. Data Replay : How to Replay Recorded Data	15
Additional Features	16
Trigger Functions to Control Recording Start/Stop Operations	16
Span, Position and Trace Functions to Adjust the Waveform Display	18
Specifications	19
Standard Specifications	19
External Input/Output Functions	19
Specification of input section	20
Installation Guide	21

Nomenclature

Top Panel

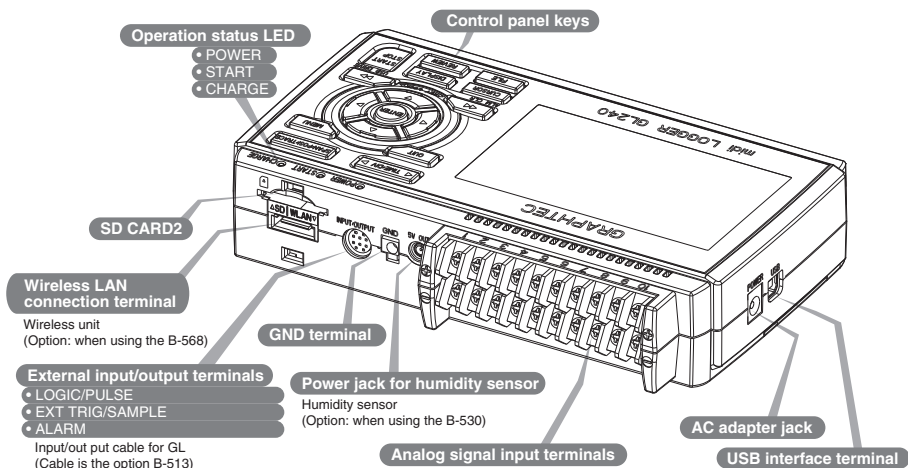

Bottom Panel

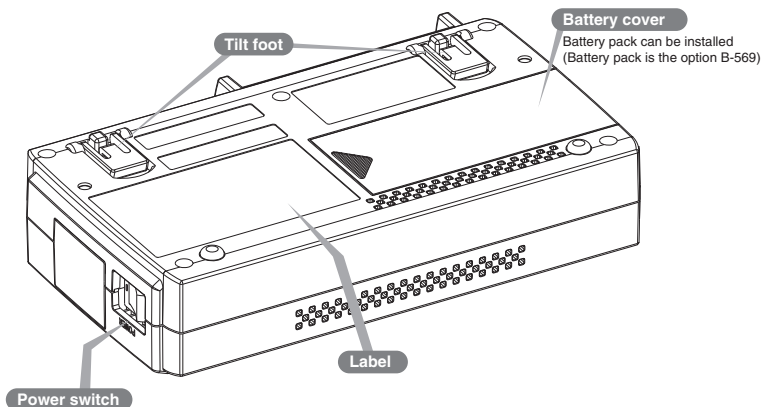

Connection Procedures

Connecting the AC Adapter

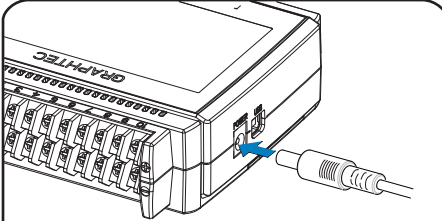

Connect the DC output of the AC adapter to the connector indicated as "DC LINE" on the GL240.

Connecting the Grounding Cable

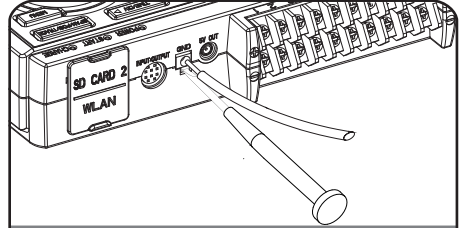

Use a flathead screwdriver to push the button above the GND terminal while connecting the grounding cable to the GL240. Connect the other end of the cable to ground.

Connect to the Analog Input Terminals

CH 10 9 8 7 6 5 4 3 2 1

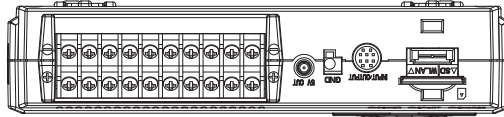

Voltage input

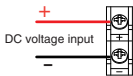

Current input

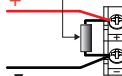

Shunt resistor

Ex: Current signal is converted to voltage using the shunt resistor.
For 4 to 20mA current to convert the signal to 1 to 5V.
Note:Graphtec offers B-551 250 ohm precision shunt resistor.

Thermocouple input

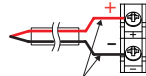

Compensation wire is used if it is required.

CAUTION: Connect wire to the designated channel, where individual channels are numbered.

Connect the External Input/Output Terminals

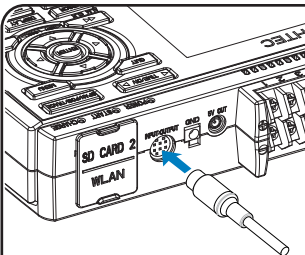

< Signal assignment >

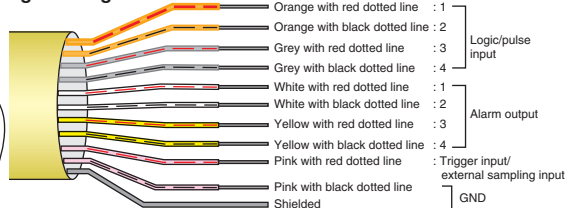

(For logic/pulse input, alarm output, trigger input, external sampling pulse input)

* Requires B-513 pulse/logic cable.

Internal memory

- The internal memory is displayed as SD1 or SD CARD1
- The internal memory is not removable.

Mounting SD CARD 2

< How to mount >

- (1) Open the protective cover to SD CARD 2.
- (2) Push the SD memory card until it clicks and is locked.

* SD memory card must be unlocked.

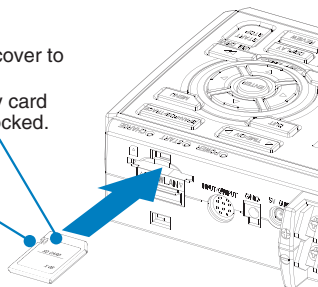

< How to remove >

- (1) The SD memory card is released by pushing gently on the card. Then, pull to remove the card.



CAUTION: To remove a SD memory card, push in gently to release the card before pulling.
When the optional wireless LAN unit is installed, the SD memory card cannot be mounted.
The POWER LED blinks while accessing the SD memory card.

Connect with PC

To connect a PC using a USB cable, attach the supplied ferrite core to the USB cable as shown.

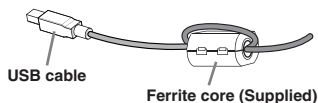

To connect GL240 and PC, use a cable with A-type and B-type connectors.

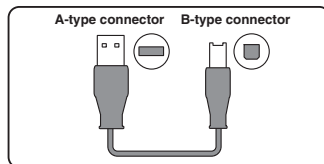

GL240 midi LOGGER complies with the EMC Directive when the supplied ferrite core is attached to a USB cable.

Safety Guide for using GL240

Maximum input voltage

If a voltage exceeding the specified value goes into the instrument, the electrical relay in the input will be damaged. Never input a voltage exceeding the specified value at any moment.

< Between +/- terminals(A) >

- Maximum input voltage: 60Vp-p (Range of 20mV to 1V)
110Vp-p (Range of 2V to 100V)

< Between Channel to channel (B) >

- Maximum input voltage: 60Vp-p
- Withstand voltage: 350 Vp-p at 1 minute

< Between Channel to GND (C) >

- Maximum input voltage: 60Vp-p
- Withstand voltage: 350 Vp-p at 1 minute

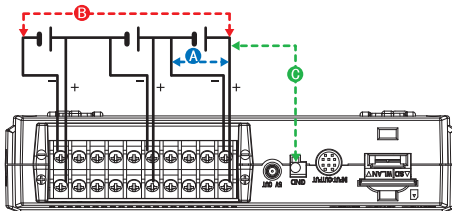

Warm-up

GL240 requires approximately 30 minutes warm-up time to deliver the optimum performance.

Unused channels

The analog input section can frequently have cases of impedance. Left open, measured value may fluctuate due to noise. To rectify, set unused channels to "Off" in the AMP setting menu or short the + and – terminals for better result.

Noise countermeasures

If measured values fluctuate due to extraneous noise, run the following countermeasures. (Results may vary according to noise type.)

- Ex 1 : Connect the GL240's GND input to ground.
- Ex 2 : Connect GL240's GND input to measurement object's GND.
- Ex 3 : Operate GL240 with batteries (Option: B-569).
- Ex 4 : In the AMP settings menu, set filter to any setting other than "Off".
- Ex 5: Set the sampling interval which enables GL240's digital filter (see table below).

Number of Measuring Channels *1	Allowed Sampling Interval	Sampling Interval which enables Digital Filter
1 Channel or less	10 msec or slower *2	50 msec or slower
2 Channels or less	20 msec or slower *2	125 msec or slower
5 Channels or less	50 msec or slower *2	250 msec or slower
10 Channels or less	100 msec or slower	500 msec or slower

*1 Number of Measuring Channels is the number of active channels in which input settings are NOT set to "Off" .

*2 Temperature cannot be set when the active sampling interval is set to 10 ms, 20 ms or 50 ms.

Descriptions of the Control Panel Keys

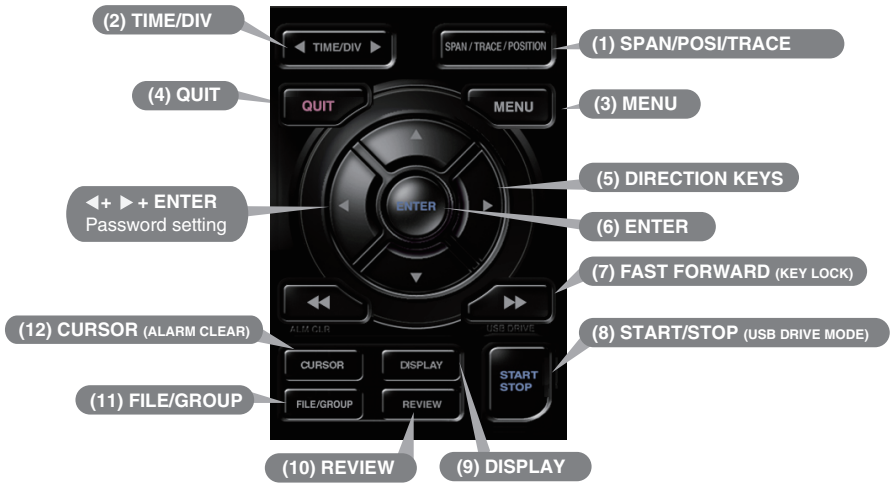

1. SPAN/POSI/TRACE

The key allows SPAN, POSITION, and TRACE settings to be made independently for each channel. When the key is pushed, the display mode changes in the sequence shown below. Use the ▲ and ▼ keys to select the channel, and the ◀ and ▶ keys to change the setting values.

Key Pointers

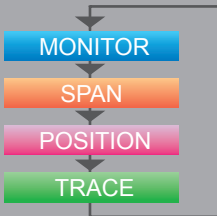

Displays digital values (default).

Change the span settings (change the waveform amplitude).

Change the position settings (adjust the upper and lower values of the waveform).

Change the trace settings (set the waveform display to On or Off).

* If the [QUIT] key is pushed when the GL240 is in the SPAN, POSITION, or TRACE mode, the display returns to MONITOR mode.

2. TIME/DIV

Push the [TIME/DIV] key to change the time axis display range on the waveform screen.

3. MENU

Push the [MENU] key to open a setup menu. As you push the [MENU] key the setup screen tabs change in the sequence shown below.

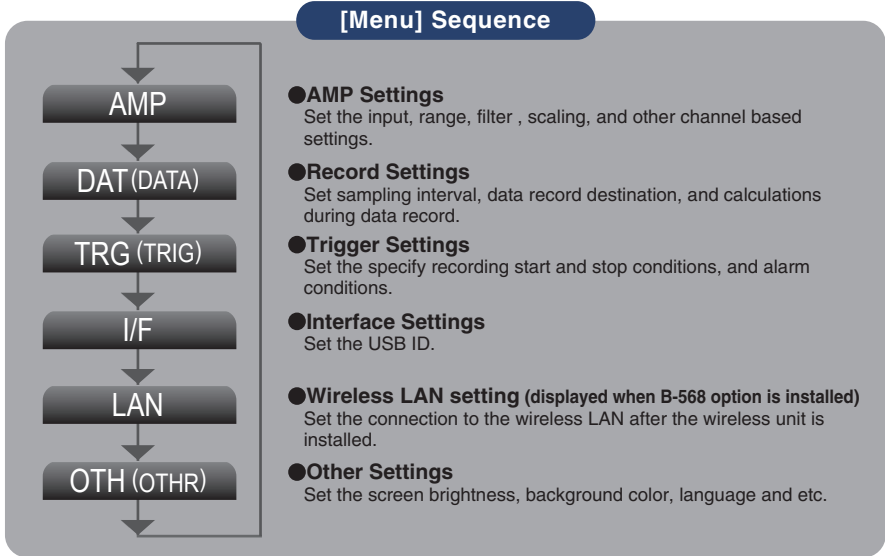

4. QUIT (LOCAL)

Push the [QUIT] key to cancel the settings and return to the default status. If GL240 is in a Remote (Key Lock) status and is run by a computer via a USB or WLAN interface, push the key to return to a normal operating status. (Local).

5. Keys (DIRECTION KEYS)

Direction keys are used to select menu setup items, to make span settings in the digital display area, or to move the cursors during a data replay operation.

6. ENTER

Push the [ENTER] key to submit the setting and to confirm your settings.

7. Keys (KEY LOCK)

Fast forward and rewind keys are used to move the cursor at high speed during replay or change the operation mode in the file box. Hold down both keys simultaneously for at least two seconds to lock the key buttons. (Orange key at the top right of window indicates locked status).

To cancel key lock status, push both key again for at least two seconds.

* Pushing these keys simultaneously with the ◀ key + ENTER + ▶ key enables password protection for the key lock operation.

8. START/STOP (USB DRIVE MODE)

Push the [START/STOP] key to initiate start and stop of a recording when GL240 is in the Free Running mode.

If the key is pushed while turning the power to the GL240 on, the unit will switch from the USB connection to USB DRIVE mode.

* For more information about the Drive Mode of the USB, refer to the User's Manual in the supplied CD.

9. DISPLAY

Push the [DISPLAY] key

```
graph TD; A[Waveform + Digital] --> B[Expanded Waveform]; B --> C[Digital + Calc]; C --> A;
```

Key Pointers

- **Waveform + Digital**
Default screen when the GL240 is initially turned on with both the waveforms and digital values.
The screen settings can be changed by using the [SPAN/POSI/TRACE] key.
- **Expanded Waveform**
Displays expanded waveforms only.
- **Digital + Calc**
Displays large-size digital values and two types of calculation processing results. The calculation settings are made in the "DATA" menu.
Use the ◀◀ key or ▶▶ key to switch digital display mode. (available digital channel displays:2,4,10).

* For more information, refer to the User's Manual in the supplied CD.

10. REVIEW

Push the [REVIEW] key to replay recorded data. If the GL240 is in the Free Running mode, data files that have already been recorded will be displayed. If the GL240 is still recording data, the data is replayed in a 2-screen format. Press the [REVIEW] button to switch between the recorded data and real time data.

* A data replay operation will not be performed if data has not been recorded.

11. FILE

This is used to operate the internal memory (SD1) and SD memory card (SD2), or for file operation, screen copy, and save/load current settings.

12. CURSOR (ALARM CLEAR)

Push the [CURSOR] key to switch between the A and B cursors during data replay. If the Alarm setting is specified as "Alarm Hold", push the key to clear the alarm. The alarm settings are made in the "TRIG" menu.

Descriptions of the Menu Screens

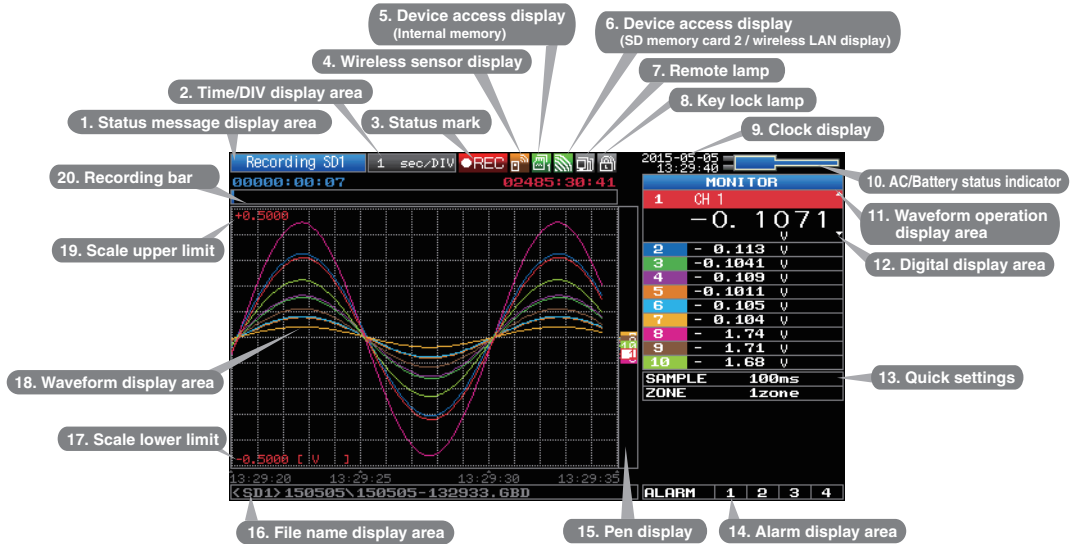

1. **Status message display area** : Displays the operating status.
2. **Time/DIV display area** : Displays the current time scale.
3. **Status mark** : Displays the status mark.
4. **Wireless sensor display** : Displayed when connecting the GL100-WL (GS sensor and terminal / module connection) to the wireless LAN.
5. **Device access display (Internal memory)** : Displayed in red when accessing the internal memory (SD1).
6. **Device access display (SD memory card 2 / wireless LAN display)** : Displayed in red when accessing the SD memory card (SD2). When the SD memory card (SD2) is inserted, it is displayed in green. (When the child unit is connected through the wireless LAN, the radio field intensity of the base unit is displayed. When setting to the base unit, the child unit (wireless sensor) which can be connected to the GL100-WL is one unit only.)
7. **Remote lamp** : Displays the remote status. (Orange = Remote status, white = Local status)
8. **Key lock lamp** : Displays the key lock status. (Orange = keys locked, white = not locked)
9. **Clock display** : Displays the current date and time.
10. **AC/Battery status indicator** : Displays the following icons to indicate the operating status of the AC power and the battery. (see right figure)
Note: Use this indicator as a guideline because remaining battery power is an estimate. This indicator does not guarantee the operating time with battery.
11. **Waveform operation display area** : Displays the mode selected by the [SPAN/POSI/TRACE] key.

Status mark

- STOP Free Running status
- REC Trigger waiting status
record end status
- REC Recording status
- PLAY Data replay status

Status icon

- SD memory card accessing
- SD memory card is inserted
- SD memory card is not inserted
- Radio field intensity display of base unit (from Strong to Weak)
- Wireless sensor registration /recognition display
- Wireless sensor registration /unrecognition display

AC/Battery Indicator

- When the AC power supply is being used
- Battery power: 100 - 91%
- Battery power: 90 - 61%
- Battery power: 60 - 31%
- Battery power: 30 - 11%
- Battery power: 10% or less

- 12. **Digital display area** : Displays the input values for each channel. The ▲ and ▼ keys can be used to select the active channel (enlarged display). The selected active channel is displayed at the very top of the waveform display.
- 13. **Quick settings** : Displays items that can be easily set. The ▲ and ▼ keys can be used to activate a Quick settings item, and the ◀ and ▶ keys to change the values.
- 14. **Alarm display area** : Displays the status of the alarm output. (Red = alarm generated, white = alarm not generated)
- 15. **Pen display** : Displays the signal positions, trigger positions, and alarm ranges for each channel. (see right figure)
- 16. **File name display area** : Displays the recorded file name during the recording operation. When data is being replayed, the display position and cursor information are displayed here.
- 17. **Scale lower limit** : Displays the lower limit of the scale of the currently active channel.
- 18. **Waveform display area** : The input signal waveforms are displayed here.
- 19. **Scale upper limit** : Displays the upper limit of the scale of the currently active channel.
- 20. **Recording bar** : Indicates the remaining capacity of the recording medium during data record. When data is being replayed, the display position and cursor information are displayed here.

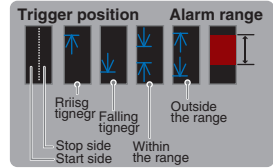

Measuring Procedure

A basic information on the recording process:

Preparations -> Setup -> Record data -> Replay Data.

Example: voltage and temperature measurements.

- Purpose : To measure voltage and temperature of the target objects
- Temperature thermocouple: T type Thermocouple, 100°C
- Voltage range : 1V
- Sampling interval : 1 sec
- Data save destination : Internal memory (SD1)

1. Preparations : Hardware set up for Data Recording

1. Connect wire to CH 1 terminal (Voltage).
2. Connect Thermocouple to CH 2 terminal (Temperature).
3. Connect the AC power supply.
4. Turn the power supply on.

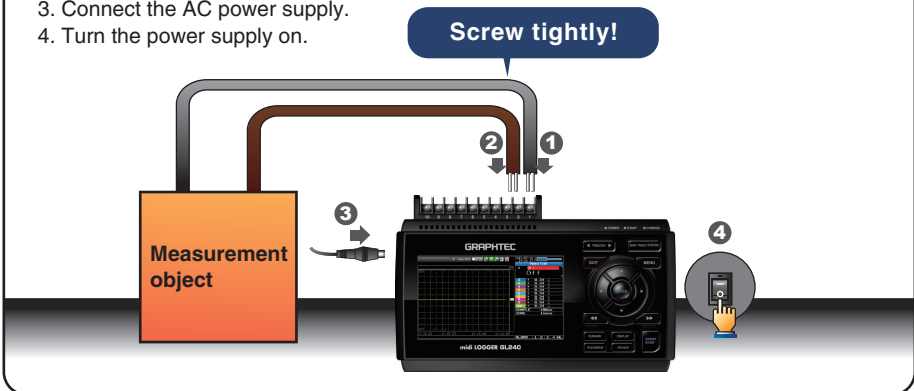

2. Setup : Menu Operation

Select the setting for only the channels being recorded. Make sure to turn off unused channels. It is unnecessary to change all settings from factory default.

Key Pointers

Basic Setup Menu Operation

The \blacktriangle , \blacktriangledown , \blacktriangleleft , \blacktriangleright , [ENTER], and [QUIT] keys are used to set the condition on the setup menu. The current position of the cursor on the setup menu is displayed in green.

Use the \blacktriangle , \blacktriangledown , \blacktriangleleft , \blacktriangleright keys to move the cursor. When the [ENTER] key is pushed at the cursor position, a selection menu or a box entering value for other option is displayed.

If you push the [QUIT] key, the screen closes and for the option settings are canceled.

Examples of selection menu operations (AMP screen)

1. Use the \blacktriangledown , \blacktriangle , \blacktriangleleft , \blacktriangleright keys to move the cursor to the Input parameter of CH 1 and then push the [ENTER] key.

AMP DAY TAG I/F LAN OTH					
*Display logic/pulse data					
CH:		Input	Sensor	Range	
ALL:	M	DC		50 V	
1:	M	DC		50 V	
2:	M	DC		50 V	
3:	M	DC		50 V	
4:	M	DC		50 V	
5:	M	DC		50 V	

2. A selection menu is displayed when the [ENTER] key is pushed. Use the \blacktriangledown and \blacktriangle keys to select "TEMP."

AMP DAY TAG I/F LAN OTH					
*Display logic/pulse data					
CH:		Input	Sensor	Range	
ALL:	M	DC		50 V	
1:	M	DC		50 V	
2:	M	Off		50 V	
3:	M	DC		50 V	
4:	M	TEMP		50 V	
5:	M	RH		50 V	

3. Pushes the [ENTER] key to confirm your selection.

AMP DAY TAG I/F LAN OTH					
*Display logic/pulse data					
CH:		Input	Sensor	Range	
ALL:	M	TEMP	TC-T	2000 °C	
1:	M	TEMP	TC-T	2000 °C	
2:	M	DC		50 V	
3:	M	DC		50 V	
4:	M	DC		50 V	
5:	M	DC		50 V	

(Note: Select "DC" for voltage measurement, and "TEMP" for temperature measurement.)



1. Push the [MENU] key to display the setup menu screen.

2. Set Input to "DC" and Range to "1V" for CH1, and set Input to "TEMP" and Sensor to "TC-T" for CH2.

- (1) Move the cursor to CH1 "Input" and select "DC" and then move to "Range" and select "1V".

AMP DAY TAG I/F LAN OTH					
*Display logic/pulse data					
CH:		Input	Sensor	Range	Filter
ALL:	M	DC		50 V	Off
1:	M	DC		50 V	Off
2:	M	TEMP	TC-K	2000 °C	Off
3:	M	DC	TC-T	2000 °C	Off
4:	M	DC		50 V	Off
5:	M	DC		50 V	Off
6:	M	DC		50 V	Off
7:	M	DC		50 V	Off
8:	M	DC		50 V	Off
9:	M	DC		50 V	Off
10:	M	DC		50 V	Off

- (2) In the same way, move the cursor to CH2 "Sensor" and select "TC-T".



3. Select "Off" for all the other channels.

- (1) Using the procedure described above, select "Off" for CH 3 to CH 10.

AMP DAY TAG I/F LAN OTH					
*Display logic/pulse data					
CH:		Input	Sensor	Range	Filter EU Misc.
ALL:	M	TEMP	TC-T	2000 °C	Off
1:	M	DC		1 V	Off
2:	M	TEMP	TC-T	2000 °C	Off
3:	M	Off			Off
4:	M	Off			Off
5:	M	Off			Off
6:	M	Off			Off
7:	M	Off			Off
8:	M	Off			Off
9:	M	Off			Off
10:	M	Off			Off

4. Push the [MENU] key and open the "DATA" menu.



5. Set the sampling interval to "1s".

Move the cursor to "Sampling" and then select "1s".

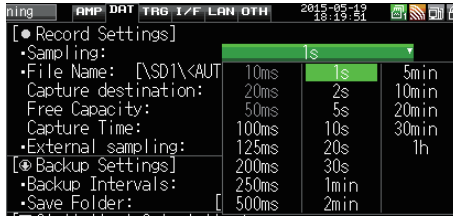

6. Set the Data Recording Medium to "SD memory card".

Here, a sample folder "TEST" will be created in the internal memory (SDI), and then set the recorded data to be placed inside the "TEST" folder.

- (1) Move the cursor to the File Name parameter and then push the [ENTER] key.



- (2) The data save destination box shown in the following screen opens. In the data saving destination box, set the SD1 as the Recording Medium.

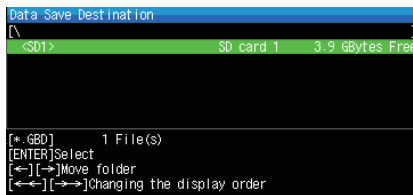

- (3) Move into the folder by pushing the [▶] key and move the cursor to the "Create New Folder" and then push the [ENTER] key. The Folder Name Input menu will be displayed.



- (4) A text input box is displayed. Create a folder named "TEST".

- (1) In the text type select; delete; insert; confirm items, move the cursor to the A using the ◀ and ▶ keys.
- (2) The selected text is displayed.

In the text select, move the cursor to the text using the ▲, ▼, ◀ and ▶ keys and then push the [ENTER] key.

Input "TEST", move the cursor to [OK], and then push the [ENTER] key to enter your setting.

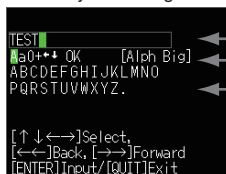

Text input box

(1) Select the text type, delete, insert, confirm

(2) Select the character



(6) Return to the Data Save Destination screen in (2). Next select the "TEST" folder and then push the [ENTER] key.

(7) Move the cursor to **OK** and then push the [ENTER] key.



Data records using the automatic file naming which includes date and time stamp in the internal memory (SD1).

(8) Available space in specified memory and available data recording time are displayed in the lower part of the Record Settings menu.

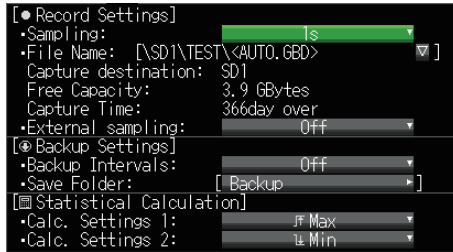

Minimum required setting for recording is now complete.

3. Data record : How to Record

Once required settings are stored, user can initiate the data recording while it is recording. Recorded data is available for replay.

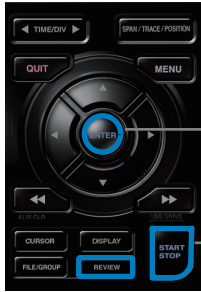

1. Start recording

- (1) Push the [START/STOP] key.
- (2) A confirmation message is displayed.

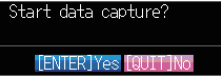

- (3) Push the [ENTER] key to start recording.

2. Screen status during data recording

Once recording start, progress is visible on the screen. The displayed time is counts up or down.

Recording message



elapsed time

remaining time for recording

(The indication becomes ++++ when the available recording time is 9999 hours or more.)

Key Pointers

Recorded Data can be viewed while recording is in progress by pushing the [REVIEW] key. Data is available for viewing from the start to the point of real-time recording while in progress.

During data replay, arbitrary level values can be viewed by moving the cursor. Return to the recording screen by pushing the [REVIEW] key again.

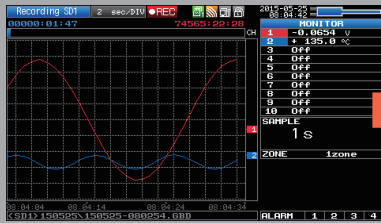

* The [DISPLAY] key allows you to switch between the 1-screen and 2-screen.



3. Stop recording

Push the [START/STOP] key to end the recording operation.

- (1) Push the [START/STOP] key.



- (2) Confirmation message is displayed. Push the [ENTER] key.

- (3) Recording ends, and the GL240 goes into the Free Running mode.

The operation for data recording is complete.

4. Data Replay : How to Replay Recorded Data

Once the recording is complete, the recorded file is saved in the “TEST” folder of the internal memory (SD1) set in “2. Setting” .

File name is automatically assigned, in the GBD-format (Year,Month,Day – Time.GBD).

Time indicates the start time for the recorded data.

Example:150525-080254.GBD(following screen)



1. Selecting a file to replay

- (1) Push the [REVIEW] key.
- (2) Select data to be reviewed, move the cursor to the [OK] button and [ENTER] key.



2. Replay screen

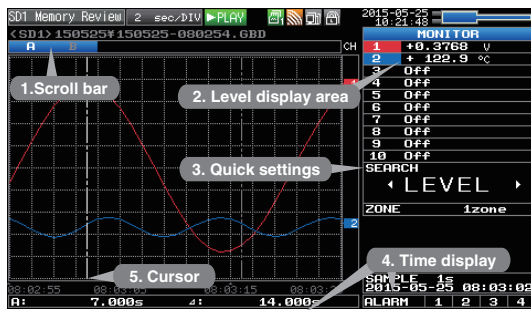

- (1) Scroll bar : Displays the position within the whole data and the display width.
- (2) Level display area : Displays the levels of A and B cursors and the difference between the A and B values.
- (3) Quick settings : Use the ◀▶ keys to search the previous or next level. (Note: Make search settings in the menu.)
- (4) Time display : Displays the sampling interval and the time of the cursor.
- (5) Cursor : Displays the cursor. (Note: Push the CURSOR key to switch between A and B cursors.) Move the cursor using the ◀▶ keys or the ◀◀▶▶ keys. Desired level values and time can be checked by moving the cursor.



- Push the [QUIT] key to end the data replay operation.
- A confirmation message is displayed. Push the [ENTER] key.

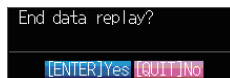

Data replay ends, and the GL240 goes into the Free Running mode.

GL240 has many additional features. Please refer to the following pages for details.

Additional Features

GL240 has various functions that enhances and allows data to be collected and displayed more effectively. The following three functions describe these in details.

Trigger Functions to Control Recording Start/Stop Operations

Trigger functions control the timing of the start of the data recording and the timing of the end of a data recording.

Key Pointers

For example...

The trigger function can perform following operations:

- Start recording when the voltage exceeds 1 V
- Stop recording at 1:00 pm
- Perform control via external input

Here recording starts with the condition set as "Start recording when the CH 1 temperature exceeds 20°C".

(1) Push the [MENU] key and open the "TRIG" menu.

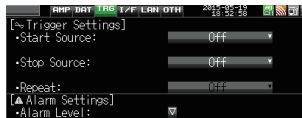

(2) Move the cursor to "Start Source" and select "Level".



(3) Push the [ENTER] key according to the "Level Settings" . The "Trigger Level Settings" screen is displayed. Move the cursor to the "Mode" parameter for the CH1, and then select "Hi".

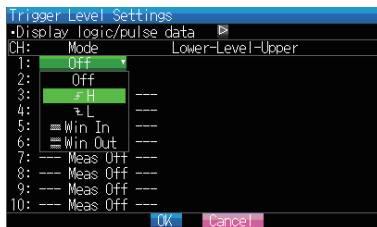



- (4) Move the cursor to the "Level" parameter next to the "Mode" parameter and then push the [ENTER] key.
- (5) The input box shown in the following screen is displayed. Select "20". Use the ◀ and ▶ keys to move to the cursor to the second digit from the right, and the ▲ and ▼ keys to change the value. Push the [ENTER] key.

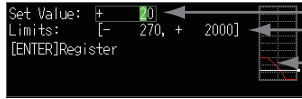

- Numerical value input box
- Lower and upper limit for setting.
- Waveform area for confirmation
 - Use the ▲ and ▼ keys to change the values.
 - Use the ◀ and ▶ keys to move the digit.
 - Use the [ENTER] key to enter the value.
 - Use the [QUIT] key to cancel the setting.

- (6) When the screen changes to the following screen, move the cursor to the **OK** button and then push the [ENTER] key.

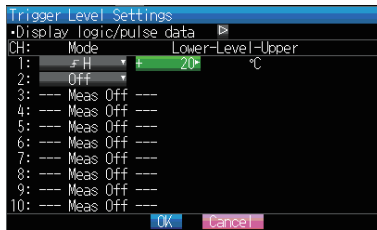

- (7) The screen returns to the TRIG menu screen. Push the [QUIT] key to return the GL240 to the Free Running mode.
- (8) Push the [START/STOP] key to start data record. If the trigger condition has not been satisfied, the GL240 goes into the "Armed" status as shown on the following screen.



When the trigger condition is satisfied, the recording starts.



Span, Position and Trace Functions to Adjust the Waveform Display

Trigger functions can be used to control the timing of the start of a recording, and the timing of the end of a recording.

Key Pointers

The span, position and trace operations can be performed while the GL240 is in the Free Running mode, while it is recording data, replaying data. The changes are applied to the displayed data only, and this change does not affect the recorded data.

1. How to change the Span setting

The Span parameter is used to adjust the amplitude of the input waveform. This setting is made in the Free Running mode.

- (1) Set the displayed span for CH 2 to 100°C.
- (2) Push the [SPAN/POSI/TRACE] key to select the SPAN mode.

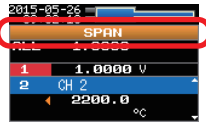

Key Pointers

The currently selected mode (SPAN, POSITION or TRACE) can be checked by looking at the "Waveform Operation Display Area".

- (3) Use the ▲ and ▼ keys to make CH 2 active (display enlarges on the selected channel).
- (4) Use the ◀ and ▶ keys to change the Span value. Here the value for span is set to 100°C. When this setting is changed, the waveform screen scale will be set to "+100.0°C to +0.0°C".

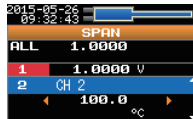

2. How to change the Position setting

The Position parameter is used to adjust the position of displayed waveform set by the upper and lower values.

- (1) Push the [SPAN/POSI/TRACE] key to select the POSITION mode.
- (2) Use the ▲ and ▼ keys to make CH 2 active (display enlarges on the selected channel).
- (3) Use the ◀ and ▶ keys to set the Position value to "+80.0°C to -20.0°C". When this setting is changed, the waveform screen scale will be set to "+80.0°C to -20.0°C".

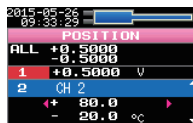

3. How to change the Trace setting.

The Trace parameter can be used to specify the selected waveform to be visible or invisible on the display.

- (1) Push the [SPAN/POSI/TRACE] key to select the TRACE mode.
- (2) Use the ▲ and ▼ keys to make CH 1 active.
- (3) Use the ◀ and ▶ keys to select Off.

When this setting is changed to Off, the CH 1 waveform will not be displayed.

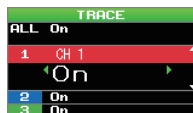

Specifications

Standard Specifications

Item	Description																													
Number of analog channels	10 channels																													
External input and output functions	Trigger input or External sample pulse (1ch), Logic input (4ch) or Pulse input (4ch), Alarm output (4ch)																													
PC interface	USB 2.0 (HighSpeed supported) , Wireless LAN (Required to install optional module.)																													
Built-in memory device	Internal memory (SD1) : approx. 4GB SD CARD2 slot: 1 (Compatible with SDHC, up to approx. 32GByte memory available) * Possible to save up to 2GB for one file																													
Number of analog channel	10ms/1ch MAX 10/20/50/100/125/200/250/500ms, 1/2/5/10/20/30sec 1/2/5/10/20/30min, 1hour, External * In the case of 50 ms or less, available settings vary depending on the input settings and number of CHs to be measured.																													
Back-up functions	Setup parameters: EEPROM/Clock: Lithium battery																													
Clock accuracy (ambient temperature 23°C)	±0.002% (approx. 50 seconds per month)																													
Operating environment	0 to 45°C, 5 to 85%RH (0 to 40°C when operated in batteries/15 to 35°C when battery is charging)																													
Power supply	AC adapter : 100 to 240 VAC, 50 to 60 Hz DC input : 8.5 to 24 VDC (26.4 V max.) Battery pack (option) : 7.2 VDC (2900 mAh)																													
Power consumption	AC power consumption * when using the AC adapter provided as a standard accessory																													
	<table border="1"> <thead> <tr> <th>No</th> <th>Condition</th> <th>Normal</th> <th>During recharging battery</th> </tr> </thead> <tbody> <tr> <td rowspan="2">1</td> <td rowspan="2">When the LCD is on</td> <td>AC100 V</td> <td>16 VA</td> <td>36 VA</td> </tr> <tr> <td>AC240 V</td> <td>24 VA</td> <td>52 VA</td> </tr> <tr> <td rowspan="2">2</td> <td rowspan="2">When the screen saver is operating</td> <td>AC100 V</td> <td>15 VA</td> <td>35 VA</td> </tr> <tr> <td>AC240 V</td> <td>22 VA</td> <td>51 VA</td> </tr> </tbody> </table>	No	Condition	Normal	During recharging battery	1	When the LCD is on	AC100 V	16 VA	36 VA	AC240 V	24 VA	52 VA	2	When the screen saver is operating	AC100 V	15 VA	35 VA	AC240 V	22 VA	51 VA									
	No	Condition	Normal	During recharging battery																										
	1	When the LCD is on	AC100 V	16 VA	36 VA																									
			AC240 V	24 VA	52 VA																									
	2	When the screen saver is operating	AC100 V	15 VA	35 VA																									
			AC240 V	22 VA	51 VA																									
	DC current consumption * Normal condition: LCD brightness is set to MAX.																													
	<table border="1"> <thead> <tr> <th>No</th> <th>Condition</th> <th>Normal</th> <th>During recharging battery</th> </tr> </thead> <tbody> <tr> <td>1</td> <td rowspan="2">+24 V</td> <td>When the LCD is on</td> <td>0.24 A</td> <td>0.61 A</td> </tr> <tr> <td>2</td> <td>When the screen saver is operating</td> <td>0.22 A</td> <td>0.59 A</td> </tr> <tr> <td>3</td> <td rowspan="2">+12 V</td> <td>When the LCD is on</td> <td>0.42 A</td> <td rowspan="2">Recharging battery is not possible.</td> </tr> <tr> <td>4</td> <td>When the screen saver is operating</td> <td>0.37 A</td> </tr> <tr> <td>5</td> <td rowspan="2">+8.5 V</td> <td>When the LCD is on</td> <td>0.58 A</td> <td rowspan="2">Recharging battery is not possible.</td> </tr> <tr> <td>6</td> <td>When the screen saver is operating</td> <td>0.53 A</td> </tr> </tbody> </table>	No	Condition	Normal	During recharging battery	1	+24 V	When the LCD is on	0.24 A	0.61 A	2	When the screen saver is operating	0.22 A	0.59 A	3	+12 V	When the LCD is on	0.42 A	Recharging battery is not possible.	4	When the screen saver is operating	0.37 A	5	+8.5 V	When the LCD is on	0.58 A	Recharging battery is not possible.	6	When the screen saver is operating	0.53 A
	No	Condition	Normal	During recharging battery																										
1	+24 V	When the LCD is on	0.24 A	0.61 A																										
2		When the screen saver is operating	0.22 A	0.59 A																										
3	+12 V	When the LCD is on	0.42 A	Recharging battery is not possible.																										
4		When the screen saver is operating	0.37 A																											
5	+8.5 V	When the LCD is on	0.58 A	Recharging battery is not possible.																										
6		When the screen saver is operating	0.53 A																											
External dimensions (approximate)	[WxDxH] :188×117×42 mm																													
Weight (approximate)	500 g * AC adapter and battery are not included.																													
Vibration-tested conditions	Equivalent to automobile parts Type 1 category A classification																													

External Input/Output Functions

Item	Description
Input specifications (pulse/logic, trigger/ External sampling)	Maximum input voltage : 0 to +24V (single-ended ground input)
	Input threshold voltage : approximate +2.5 V
	Hysteresis : approximate 0.5 V (+2.5 V to +3 V)
Alarm output specifications	Output format : Open collector output (5 V, 10 k pull-up resistance) * Refer to the User's Manual in the supplied CD-ROM for more information.

Specification of the input section

Item	Description		
Number of input channels	M3 screw type terminal (Rectangular flat washer) 10 channels		
Method	Photo MOS relay scanning system, all channels isolated, balanced input		
Scan speed	10ms/1Ch		
Measurement ranges	Voltage	20/50/100/200/500 mV, 1/2/5/10/20/50/100 V, 1-5 V F.S.	
	Temperature	Thermocouple : K, J, E, T, R, S, B, N, W (WR5-26)	
		Temperature range : Fixed	
Humidity	0 to 100% (voltage 0 V to 1 V scaling conversion) * B-530 (optional) use		
Measurement accuracy *1 (23°C ±5°C) • When 30 minutes or more have elapsed after power was switched on • Sampling 1 s / 10 ch • Filter ON (10) • GND connected	●Voltage : ±0.1% of F.S. ●Thermocouple *1: Thermocouple diameters T, K: 0.32 , others: 0.65		
	Type	Measurement Temperature Range Measurement Accuracy	
	R/S	0 TS 100°C	±5.2°C
		100<TS 300°C	±3.0°C
		R: 300<TS 1600°C	± (0.05% of rdg +2.0°C)
		S: 300<TS 1760°C	± (0.05% of rdg +2.0°C)
	B	400 TS 600°C	±3.5°C
		600<TS 1820°C	± (0.05% of rdg +2.0°C)
	K	-200 TS -100°C	± (0.05% of rdg +2.0°C)
		-100<TS 1370°C	± (0.05% of rdg +1.0°C)
E	-200 TS -100°C	± (0.05% of rdg +2.0°C)	
	-100<TS 800°C	± (0.05% of rdg +1.0°C)	
T	-200 TS -100°C	± (0.1% of rdg +1.5°C)	
	-100<TS 400°C	± (0.1% of rdg +0.5°C)	
J	-200 TS -100°C	±2.7°C	
	-100<TS 100°C	±1.7°C	
N	100<TS 1100°C	± (0.05% of rdg +1.0°C)	
	-200 TS<0°C	± (0.1% of rdg +2.0°C)	
	0 TS 1300°C	± (0.1% of rdg +1.0°C)	
W	0 TS 2000°C	± (0.1% of rdg +1.5°C)	
Reference contact compensation accuracy		±0.5°C	
A/D converter	16-bit Delta-Sigma A/D converter (Effective resolution: approx. 1/40,000 of ± range)		
Temperature coefficient	Gain : 0.01% of F.S./°C Zero : 0.02% of F.S./°C * Occurs when sampling interval is 10, 20, or 50 ms.		
Maximum input voltage	Between +/- terminals : 20mV to 1V(range 60Vp-p) 2V to 100V range (110Vp-p)		
	Between input terminal/input terminal : 60Vp-p		
	Between input terminal/GND : 60Vp-p		
Withstand voltage	Between input terminal/input terminal : 1 minute at 350Vp-p		
	Between input terminal/GND : 1 minute at 350Vp-p		
Common mode rejection ratio	At least 90 dB (50/60 Hz; signal source 300 or less)		
Noise	At least 48 dB (with +/- terminals shorted)		

Installation Guide

Installing the GL240 application software.

System Requirements

The following conditions are required to install a software.

- OS : Windows 10 (32Bit/64Bit)
Windows 8.1 (32Bit/64Bit)
Windows 8 (32Bit/64Bit)
Windows 7 (32Bit/64Bit) * Starter Edition are not supported.
Windows Vista (32Bit/64Bit)
* The OSs which OS maker support has been completed are not supported.
- CPU : Pentium4 1.7GHz or higher
- Memory : 256MB or more (512MB or more recommended)
- HDD : 200MB (1GB recommended) additional space required for installing the application software
- Display : Resolution 1024 x 768 or higher, 65535 colors or above
(16 Bit or higher)
- Others : CD-ROM drive (for installation from a CD) and USB port are necessary.

To Install the USB Driver

To connect GL240 to a PC with the USB interface. PC must have USB driver installed.

A USB driver and the USB driver installation manual are stored on the supplied CD-ROM. Install the USB driver according to this manual.

(The manual location: D:\USB Driver\English\GL-USB-UM152.PDF)

Note: D: drive name of CD-ROM. The letter of CD-ROM drive vary it with the CD-ROM drive of your PC.

Note: Refer to Graphtec website for latest version of the USB driver.

To Install GL240 Application Software

Follow the steps below for installation of application software for GL240.

1. Insert the accompanying midi LOGGER GL240 CD-ROM in the PC's CD drive.
2. Select [Start] > [Run] to open the [Run] window.
3. In the [Open] field, type in "D:\GL100_240_840-APS\Setup_English.exe" and push [OK].
The installer starts.
4. Follow all directions displayed by the installer to continue.

Note: D: drive name of CD-ROM. The letter of CD-ROM drive vary it with the CD-ROM drive of your PC.

Note: Refer to Graphtec website for latest version of the application software.

GRAPHTEC

Specifications are subject to change without notice.

GL240 Quick Start Guide
(GL240-UM-852)

April 10, 2018
1st edition-01

Publisher GRAPHTEC CORPORATION